

FURUNO

OPERATOR'S MANUAL

*MARINE VHF
RADIOTELEPHONE*

Model **FM-4850**

FURUNO ELECTRIC CO., LTD.

9-52 Ashihara-cho,
Nishinomiya, 662-8580, JAPAN

• FURUNO Authorized Distributor/Dealer

All rights reserved. Printed in Japan

Pub. No. OME-57090-G

(TASU) FM-4850

A : NOV. 2018

G : NOV. 07, 2025



0 0 0 1 0 0 9 6 5 2 0



SAFETY INSTRUCTIONS

The operator and installer must read the applicable safety instructions before attempting to operate or install the equipment.

WARNING	Indicates a potentially hazardous situation which, if not avoided, could result in death or serious injury.
CAUTION	Indicates a potentially hazardous situation which, if not avoided, can result in minor or moderate injury.

	Warning, Caution		Prohibitive Action		Mandatory Action
--	------------------	--	--------------------	--	------------------

WARNING	
	<p>Do not open the equipment. This equipment uses high voltage electricity which can shock, burn or cause serious injury. Only qualified personnel can work inside the equipment.</p>
	<p>If water leaks into the equipment or something is dropped into the equipment, immediately turn off the power at the switchboard. Fire or electrical shock can result.</p>
	<p>If the equipment is giving off smoke or fire, immediately turn off the power at the switchboard. Fire or electrical shock can result.</p>
	<p>If you feel the equipment is acting abnormally or giving off strange noises, immediately turn off the power at the switchboard and contact a FURUNO service technician.</p>
	<p>Do not disassemble or modify the equipment. Fire, electrical shock or serious injury can occur. If the equipment does not work properly, contact your dealer.</p>
	<p>Make sure no rain or water splash leaks into the equipment. Fire or electrical shock can result if water leaks into the equipment.</p>

WARNING	
	<p>Do not place liquid-filled containers on or near the equipment. Fire or electrical shock can result if a liquid spills into the equipment.</p>
	<p>Do not operate the equipment with wet hands. Electrical shock can result.</p>
	<p>Use the correct fuse. Use of the wrong fuse can cause fire or electrical shock.</p>
CAUTION	
	<p>Do not touch any part of the antenna when the equipment is transmitting. Electrical shock can result.</p>
	<p>Do not use high-pressure cleaners to clean this equipment. This equipment has the waterproof rating outlined in the specifications, at the back of this manual. However, the use of high-pressure cleaning equipment can cause water ingress, resulting in damage to, or failure of, the equipment.</p>

 **WARNING**

 **Turn off the power at the mains switchboard before beginning the installation. Post a warning sign near the switchboard to indicate that power should not be applied while the equipment is being installed.**

Electrical shock, serious injury or fire can result if the power is not turned off or is applied while the equipment is being installed.

 **Do not approach the antenna closer than the distances shown below when the antenna is transmitting.**

The antenna emits radio waves that can be harmful to the human body.

RF power density on antenna aperture	Distance	Description required by
100 W/m ²	0.12 m	IEC 60945
10 W/m ²	0.39 m	IEC 60945
1.2 W/m ²	2.50 m	MPE by IC
0.2 mW/cm ²	1.50 m	MPE by FCC

(MPE: Minimum Permissible Exposure)
 Maximum Antenna Gain: 6 dBi
 The antenna specification in the ISED certificate is not restricted the use of antennas.

 **This device complies with part 15 of the FCC Rules. Operation is subject to the following two conditions:**

- (1) This device may not cause harmful interference.
- (2) This device must accept any interference received, including interference that may cause undesired operation.

 **[Radiation Exposure Statement] This equipment complies with FCC radiation exposure limits set forth for an uncontrolled environment.**

This equipment complies with FCC radiation exposure limits set forth for an uncontrolled environment. This antenna should be installed with minimum distance 150cm from your body.

This transmitter must not be co-located or operating in conjunction with any other antenna or transmitter.

Note: This equipment has been tested and found to comply with the FCC standards.

These limits are designed to provide reasonable protection against harmful interference in a commercial installation. This equipment generates uses and can radiate radio frequency energy and, if not installed and used in accordance with the instructions, may cause harmful interference to radio communications. However, there is no guarantee that interference will not occur in a particular installation.

If this equipment does cause harmful interference to radio or television reception, which can be determined by turning the equipment off and on, the user is encouraged to try to correct the interference by one or more of the following measures:

- Reorient or relocate the receiving antenna.
- Increase the separation between the equipment and receiver.
- Connect the equipment into an outlet on a circuit different from that to which the receiver is connected.
- Consult the dealer or an experienced radio/TV technician for help.

 **ISED RSS warning**

This device complies with Innovation, Science and Economic Development Canada Compliance RSS standard (s). Operation is subject to the following two conditions: (1) this device may not cause interference, and (2) this device must accept any interference, including interference that may cause undesired operation of the device.

Le présent appareil est conforme aux CNR d'Innovation, Sciences et Développement économique Canada applicables aux appareils radio. L'exploitation est autorisée aux deux conditions suivantes:
 (1) l'appareil ne doit pas produire de brouillage, et
 (2) l'utilisateur de l'appareil doit accepter tout brouillage radioélectrique subi, même si le brouillage est susceptible d'en compromettre le fonctionnement.



WARNING



ISED Radiation Exposure Statement:

This equipment complies with ISED RF radiation exposure limits set forth for an uncontrolled environment. The antenna should be installed with minimum distance 250cm from your body. This transmitter must not be co-located or operating in conjunction with any other antenna or transmitter.



ISED exposition aux radiations:

Cet équipement est conforme avec ISED les limites d'exposition aux rayonnements définies pour un contrôlé environnement. L'antenne doit être installée avec une distance minimale de 250cm de votre corps. Cet émetteur ne doit pas être co-localisés ou fonctionner en conjonction avec une autre antenne ou émetteur.

Any Changes or modifications not expressly approved by the party responsible for compliance could void the user's authority to operate the equipment.



CE Compliance Statement

This product complies with CE under RED directive 2014/53/EU. The maximum antenna gain is 6dBi, which is calculated in the EIRP. The distance from observation point to the antenna is 2m.



CAUTION



Confirm that the power supply voltage is compatible with the voltage rating of the equipment.

Connection to the wrong power supply can cause fire or damage the equipment.



Observe the following safe compass distances to prevent interference to a magnetic compass:

	Standard compass	Steering compass
FM-4850	0.40 m	0.30 m
HS-4800	0.70 m	0.45 m
SP-4800	2.65 m	1.75 m

IMPORTANT NOTICES

General

- This manual has been authored with simplified grammar, to meet the needs of international users.
- The operator of this equipment must read and follow the instructions in this manual. Wrong operation or maintenance can void the warranty or cause injury.
- Do not copy any part of this manual without written permission from FURUNO.
- If this manual is lost or worn, contact your dealer about replacement.
- The contents of this manual and the equipment specifications can change without notice.
- The example screens (or illustrations) shown in this manual can be different from the screens you see on your display. The screens you see depend on your system configuration and equipment settings.
- Save this manual for future reference.
- Any modification of the equipment (including software) by persons not authorized by FURUNO will void the warranty.
- The following concern acts as our importer in Europe, as defined in DECISION No 768/2008/EC.
 - Name: FURUNO EUROPE B.V.
 - Address: Siriusstraat 86, 5015 BT, Tilburg, The Netherlands
- The following concern acts as our importer in UK, as defined in SI 2016/1025 as amended SI 2019/470.
 - Name: FURUNO (UK) LTD.
 - Address: West Building Penner Road Havant Hampshire PO9 1QY, U.K.
- All brand, product names, trademarks, registered trademarks, and service marks belong to their respective holders.

How to discard this product

Discard this product according to local regulations for the disposal of industrial waste. For disposal in the USA, see the homepage of the Electronics Industries Alliance (<http://www.eiae.org/>) for the correct method of disposal.

How to discard a used battery

Some FURUNO products have a battery(ies). To see if your product has a battery, see the chapter on Maintenance. If a battery is used, tape the + and - terminals of the battery before disposal to prevent fire, heat generation caused by short circuit.

In the European Union

The crossed-out trash can symbol indicates that all types of batteries must not be discarded in standard trash, or at a trash site. Take the used batteries to a battery collection site according to your national legislation and the Batteries Directive 2006/66/EU.

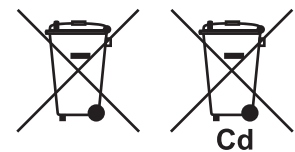

In the USA

The Mobius loop symbol (three chasing arrows) indicates that Ni-Cd and lead-acid rechargeable batteries must be recycled. Take the used batteries to a battery collection site according to local laws.

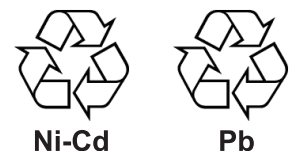

In the other countries

There are no international standards for the battery recycle symbol. The number of symbols can increase when the other countries make their own recycle symbols in the future.

Contents

FOREWORD	1
SYSTEM CONFIGURATION	3
1. GETTING STARTED	4
1.1 Emergency Call (CH16)	4
1.2 How to Call another Channel (CH16 or CH9)	4
1.3 Channels 13 and 67 (USA Channel Group only)	5
2. CONTROLS	6
2.1 Handset.....	6
3. HOME SCREEN	8
4. DIGITAL SELECTIVE CALLING	10
4.1 General	10
4.2 Maritime Mobile Service Identity	10
4.2.1 What Is an MMSI?.....	10
4.2.2 How to Enter Your MMSI Number	10
4.3 DSC Distress Call	11
4.3.1 How to Initiate a DSC Distress Call	11
4.3.2 How to Receive a DSC Distress Call.....	14
4.4 Individual Call	15
4.4.1 How to Initiate an Individual Call	15
4.4.2 How to Receive an Individual Call.....	17
4.5 Group Call	19
4.5.1 How to Initiate a Group Call	20
4.5.2 How to Receive a Group Call.....	21
4.6 All Ships Call	23
4.6.1 How to Initiate an All Ships Call	23
4.6.2 How to Receive an All Ships Call	24
4.7 Position Request Call.....	25
4.7.1 How to Initiate a Position Request Call.....	26
4.7.2 How to Receive a Position Request Call	28
4.8 Auto Position Polling	30
4.8.1 How to Enable the Auto Position Polling.....	30
4.8.2 How to Select Vessels to Which the Radio Sends Auto Position Request Calls	31
4.8.3 How to Monitor Position.....	31
4.9 DSC Log	32
4.10 DSC Test.....	33
5. CHANNEL WATCH	37
5.1 Dual Channel.....	37

5.2 Triple Channel	37
6. SCAN	39
6.1 Scan All	39
6.2 Scan All + 16	39
6.3 Memory Scan	39
6.4 Memory Scan + 16	40
6.5 Editing Memory Channel List	40
7. Weather Mode	42
8. Fog Horn/Hailer/Intercom	44
8.1 Fog Horn	44
8.2 Hailer	48
8.3 Intercom	49
8.4 Edit Handset Name	50
9. SETTING MMSI	52
10. GENERAL SETUP	53
10.1 Display Setup	53
10.1.1 Adjusting the Backlight	53
10.1.2 Adjusting the Contrast	53
10.2 Units	53
10.2.1 Time Format	53
10.2.2 Time Offset	54
10.2.3 Speed	55
10.2.4 Bearing	55
10.3 Key Beep	55
10.4 GNSS Setup	56
10.4.1 Entering the "GNSS SETUP" Page	56
10.4.2 Internal GNSS	56
10.4.3 COG/SOG Display	57
10.4.4 Manual Position	57
10.5 I/O Port Setup	58
10.5.1 Entering the "I/O PORT SETUP" Page	58
10.5.2 Selecting Output Port	58
10.5.3 GNSS OUTPUT	59
10.5.4 DSC OUTPUT	59
10.5.5 AIS OUTPUT	60
10.6 System Information	60
10.6.1 Entering the "SYSTEM INFO" Page	60
10.6.2 Software Version	60
10.6.3 Diagnostic Test	61
10.6.4 Factory Reset	61
10.7 Fog Horn Frequency	62
10.8 Service Menu	62

11. CHANNEL FUNCTION SETUP	63
11.1 Channel Group	63
11.2 Second Priority Channel.....	63
11.3 Edit Channel Name.....	64
11.4 Private Channel	65
12. DSC SETUP	66
12.1 Individual Directory	66
12.1.1 Adding an Entry.....	66
12.1.2 Editing an Entry.....	67
12.1.3 Deleting an Entry.....	68
12.2 Group Directory	68
12.2.1 Adding an Entry.....	68
12.2.2 Editing an Entry.....	69
12.2.3 Deleting an Entry.....	69
12.3 Channel Change Mode	70
12.4 Individual Acknowledgement	70
12.5 Position Acknowledgement	70
12.6 Test Acknowledgement.....	71
12.7 Auto Position Interval	71
12.8 Timeout.....	72
12.9 Alarm.....	72
13. ATIS SETUP	74
13.1 How to Enter the ATIS ID	74
13.2 How to Enable/Disable the ATIS Feature	75
14. MAINTENANCE AND TROUBLESHOOTING.....	76
14.1 General Maintenance.....	76
14.2 Troubleshooting	77
15. INSTALLATION	80
15.1 Equipment Lists	80
15.2 Mounting	82
15.2.1 How to Install the Radio.....	82
15.2.2 How to Install the Handset.....	83
15.2.3 How to Install the Speaker	84
15.3 Wiring.....	86
15.3.1 Overview.....	86
15.3.2 VHF Antenna	86
15.3.3 Ground Cable.....	89
15.3.4 Power Cable	89
15.3.5 NMEA 0183 Wire.....	91
15.3.6 Horn Speaker.....	91
15.3.7 NMEA2000 Connector (CAN bus connector)	92
15.3.8 Extension Cable.....	92
15.3.9 GPS Antenna	93

CHANNEL ASSIGNMENTS 95

MENU TREE 104

SPECIFICATIONS 108

PACKING LIST 111

OUTLINE DRAWINGS 115

INTERCONNECTION..... 121

TOOLS..... 122

FOREWORD

A Word to the Owner of the FM-4850

FURUNO Electric Company thanks you for purchasing the FM-4850 Marine VHF Radiotelephone. We are confident you will discover why the FURUNO name has become synonymous with quality and reliability.

Since 1948, FURUNO has enjoyed an enviable reputation for quality and reliability throughout the world. This dedication to excellence is furthered by our extensive global network of agents and dealers.

Your equipment is designed and constructed to meet the rigorous demands of the marine environment. However, no machine can perform its intended function unless properly installed and maintained. Please carefully read and follow the operation, installation and maintenance procedures set forth in this manual.

We would appreciate feedback from you, the end-user, about whether we are achieving our purposes.

Thank you for considering and purchasing FURUNO.

Features

FURUNO FM-4850 Marine VHF Radiotelephone supports the following features:

- All-in-One Marine VHF Radiotelephone
- 25 W or 1 W RF Output Power
- Class D DSC with Distress, Individual and All Ship calls
- Built-in AIS receiver
- Built-in high-sensitivity GNSS receiver
- 30 W PA/Loud Hailer with automatic fog signals and listen back
- NMEA2000 & NMEA0183 interface
- Up to 3 remote stations with handset HS-4800
- ATIS mode available for inland waterway in Europe
- Pre-programmed frequency band for USA, Canadian and International marine channels, plus 10 weather channels where available
- Initiate DSC call directly from NavNet TZtouch2 series when connected (Version 1950152-06.01 or later)
- Fully-waterproofed transceiver and handset (IP67)
- Quick access to channel 16/9
- Display GNSS Navigation information (LAT/LON, SOG, COG)

- Program No.: FM-4850 : 0550258-02.**; HS-4800 : 0550259-01.**.
(* denotes minor modifications.)

CE/UKCA declaration

With regards to CE/UKCA declarations, please refer to our website (www.furuno.com), for further information about RoHS conformity declarations.

SYSTEM CONFIGURATION

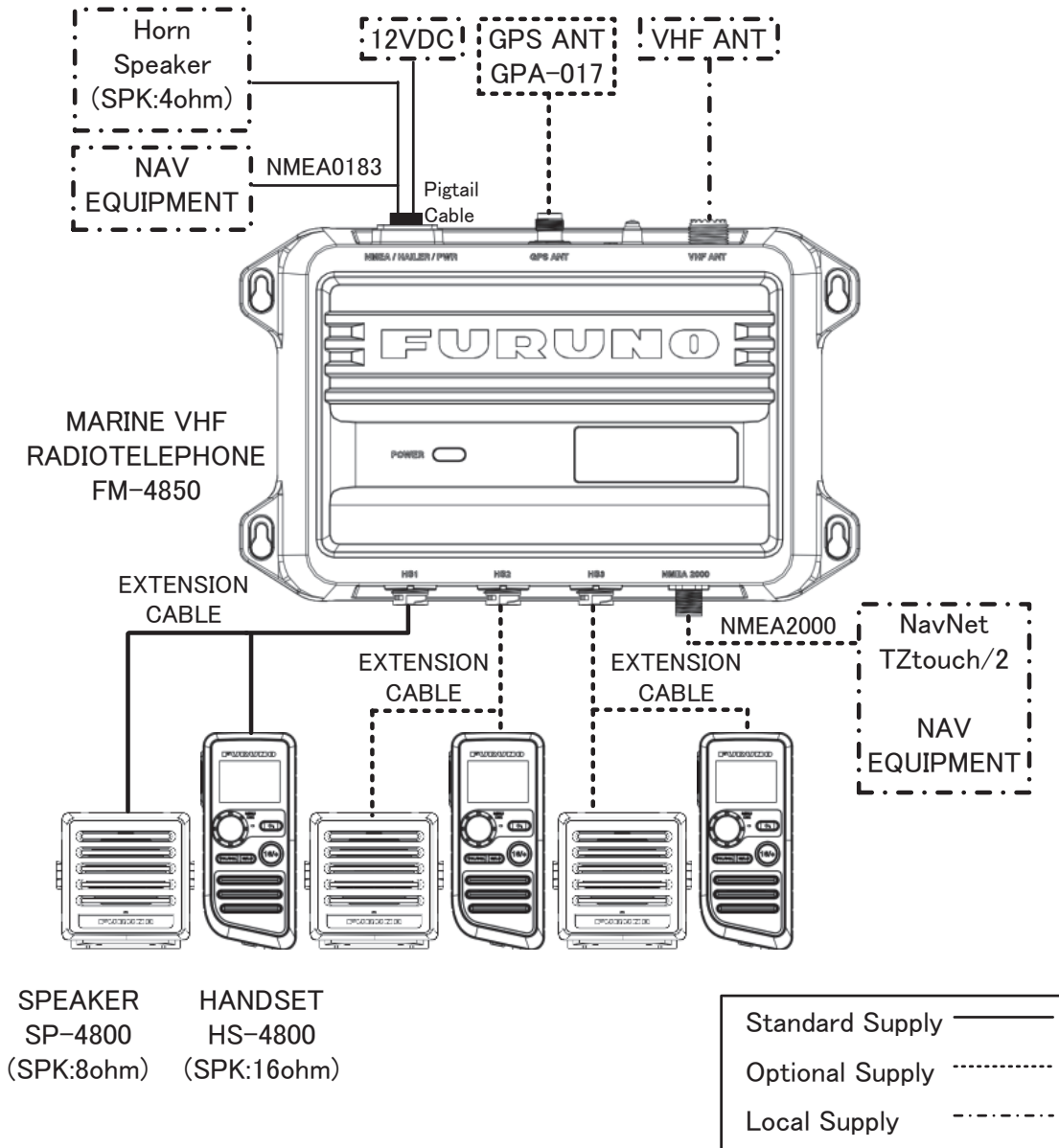

1. GETTING STARTED

1.1 Emergency Call (CH16)

CH16 is known as the Hail and Distress Channel. When an emergency occurs, be sure the radio is on and set to CH16. Then do as follows:

- Step 1 Press the **Push-To-Talk (PTT)** key of the handset and say "**Mayday, Mayday, Mayday**. This is XXXXX, XXXXX, XXXXX" (your vessel's name).
- Step 2 Then repeat once: "**Mayday, XXXXX**" (your vessel's name).
- Step 3 Report your position in latitude/longitude, or give a true or magnetic bearing to a well-known landmark such as a navigation aid or geographic feature such as an island or harbor entry.
- Step 4 Report the nature of your distress (sinking, collision, aground, fire, piracy, life-threatening injury, etc.).
- Step 5 State the kind of assistance you desire (pumps, medical aid, etc.).
- Step 6 Report the number of persons aboard and condition of them.
- Step 7 Estimate the present seaworthiness and condition of your vessel.
- Step 8 Give your vessel's description: length, design (power or sail), color and other distinguishing marks.
- Step 9 Say "**over**" to end the message. Release the **PTT** switch and listen.
- Step 10 Optional: If there is no answer, repeat the above procedure. If there is still no response, try another channel.

Note

- The total transmission should be within one minute.
- The FM-4850 has DSC Distress calling, which can send a distress call digitally to all ships with compatible DSC radios. For more information, see section 4 DIGITAL SELECTIVE CALLING.
- If the emergency call is accidentally sent, please refer to "Sending a distress cancel call" in paragraph 4.3.1.

1.2 How to Call another Channel (CH16 or CH9)

CH16 (or CH9, depending on area) should be used as the calling channel for initial contact with another vessel. However, its primary purpose is for emergency communications and should be monitored at all times when the radio is not using other channels.

CH16 or CH9 is monitored by other vessels and Coast Guard stations in all countries.

The use of CH16 or CH9 should be limited to making initial contact only. A call should be within 1 minute, but can be repeated at a 2-minute interval.

Before contact another vessel, refer to the channel charts in the Appendix and select a proper channel (working channel) for use after initial contact. Monitor the proposed channel to ensure you won't be interrupting other traffic and then go back to CH16 to make your initial call.

When CH16 is clear, state the name of the vessel you wish to call and the **"this is"** followed by the name of your vessel and your vessel call sign. When the other vessel returns your call, immediately request another channel by saying **"go to"**, the number of the other channel, and **"over"**. Then switch to the new channel. When the new channel is not busy, call the vessel.

After a transmission, say "over", and release the **PTT** switch on the handset. When all communication with the vessel is completed, end the last transmission by stating your call sign and the word **"out"**. Note that you do not need to state your call sign with each transmission, only at the beginning and end of the contact.

Remember to return to CH16 when not using another channel. Some radios automatically monitor CH16 even when set to other channels or when scanning.

1.3 Channels 13 and 67 (USA Channel Group only)

Channel 13 is used at docks and bridges and by vessels maneuvering in port. Messages on this channel must concern navigation only, such as meeting and passing in restricted waters.

Channel 67 is used for navigational traffic between vessels.

By regulation, power is normally limited to 1 Watt on these channels. Your radio is programmed to automatically reduce power to this limit on these channels. However, in emergency situations it may be temporarily use a higher power. See section 2 CONTROLS for how to temporarily override the low-power limit on these two channels.

2. CONTROLS

This section describes the controls of the handset HS-4800. It is used to control the FM-4850.

2.1 Handset

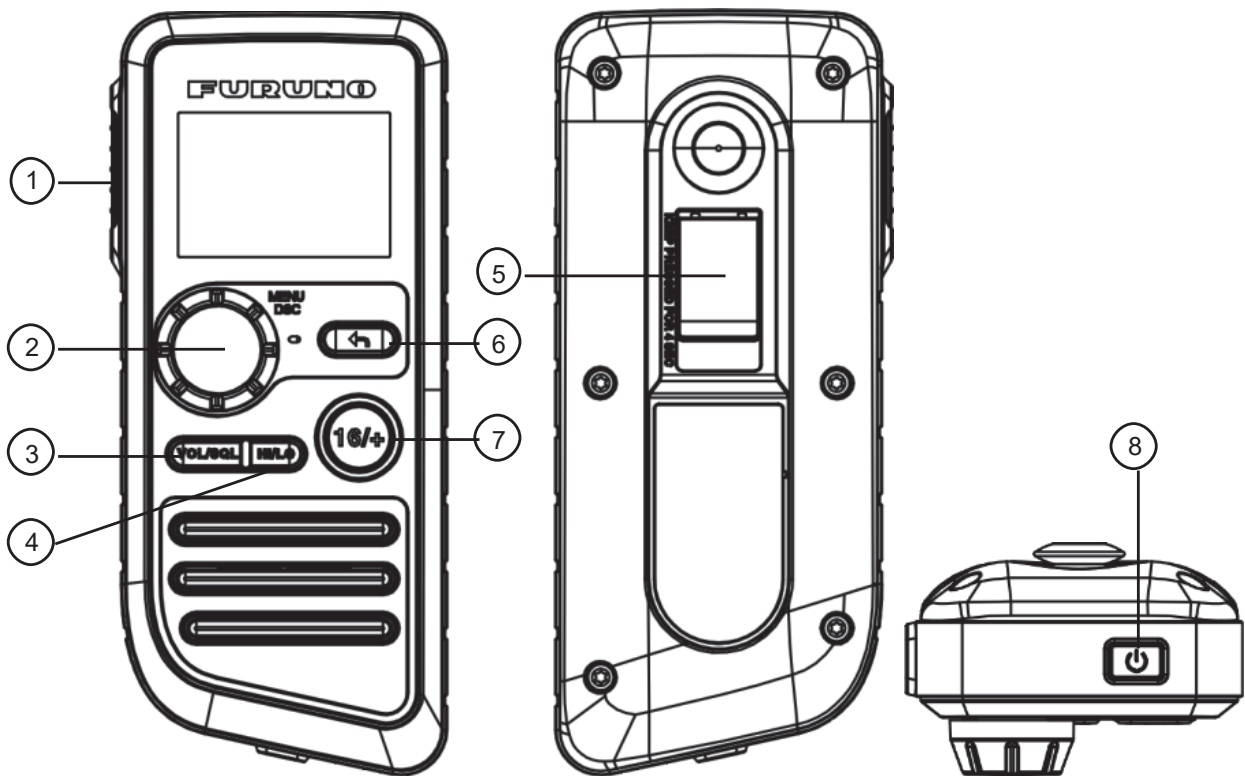



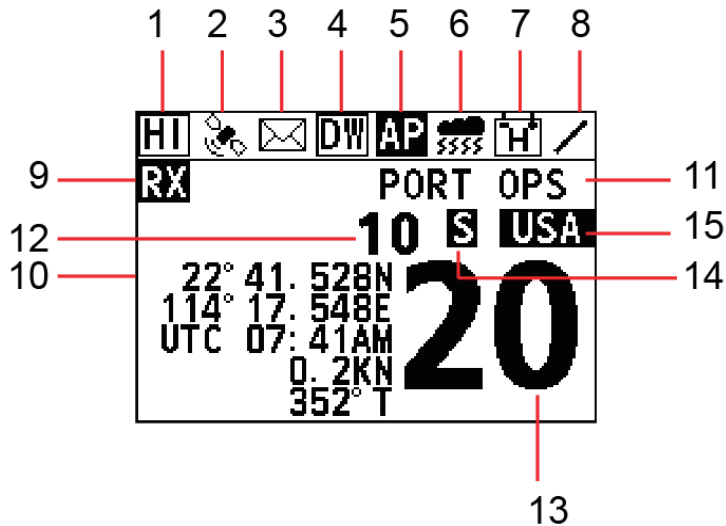

No.	Description
1	<p>[PTT]: Push-to-Talk Key The transmitter is enabled for voice communications with another vessel.</p> <p> Note When the PTT key on the handset is pressed continuously, transmission time is limited to five minutes. This limits unintentional transmissions due to a stuck PTT key. In addition, Power is automatically reduced to protect against overheating due to continuous transmission.</p>

No.	Description
2	<p>[MENU/DSC]: Menu / Digital Selective Calling (DSC) Control</p> <ul style="list-style-type: none"> ● On the home screen: <ul style="list-style-type: none"> ➤ Press: Enter "MAIN MENU" ➤ Rotate: Switch to a channel ● On other screens: <ul style="list-style-type: none"> ➤ Press: Select item or confirm the selection ➤ Rotate: Move to other item or select a number
3	<p>[VOL/SQL]: Volume / Squelch Control</p> <p>Press the key to switch between the volume adjust screen and the squelch adjust screen.</p>
4	<p>[HI/LO]: High / Low Power Switch</p> <p>Press the switch to toggle between 25 W (High) and 1 W (Low).</p>
5	<p>[DISTRESS]: Distress Key</p> <ul style="list-style-type: none"> ● Short press: Enter the distress nature selection and position manual input menu ● Long press: Press the DISTRESS key for 4 seconds to send a distress call.
6	<p>[↶]: Back Key</p> <ul style="list-style-type: none"> ● On the home screen: No function ● On other screens: <ul style="list-style-type: none"> ➤ Short press: Clear entries, cancel calls, backspace the cursor, or back up to the previous screen ➤ Long press: Return to the home screen
7	<p>[16/+]: 16/+ Key</p> <p>Press the key to cancel all other modes and to tune into the priority channels (CH16 and CH9). Press the key again to return to the previously selected working channel.</p> <p> Note</p> <p>CH9 is used in some parts of the world as an alternative calling channel to CH16.</p>
8	<p>[⏻]: On / Off Key</p> <p>Press the key to turn the handset on or off. If you turn off the last handset connected to the FM-4850, the FM-4850 will also be powered off.</p> <ul style="list-style-type: none"> ● Short press: Enter the display setup mode ● Long press: power on or power off

3. HOME SCREEN



No.	Description
1	- HI : indicates high power such as 25 W. - LO : indicates low power such as 1 W.
2	 : indicates internal and External GNSS. This icon disappears if there is no GNSS data. This icon flashes with 500ms when there is GNSS data before, but current internal GNSS and External GNSS are not fixed.
3	 : indicates unread DSC messages.
4	- DW : indicates the dual watch mode. - TW : indicates the triple watch mode.
5	AP : This icon appears if user selects START of AUTO POS POLLING->ACTIVATION. This icon disappears if user selects END of AUTO POS POLLING->ACTIVATION.
6	 : indicates weather alert.
7	- H : indicates battery strength more than 15.6V. - L : indicates battery strength lean than 10.5V.
8	Operational Status icon (Rotates clockwise to indicate system is working)
9	-No icon: FM standby. - RX : Indicates reception. - TX : Indicates transmission.

No.	Description
10	<p>Display location information including longitude, latitude, time, COG, and SOG. If there is no any information, it displays "NO GNSS DATA".</p> <p> Note There are three sensors including built-in sensor, NMEA2000 and NMEA0183. The last two are external sensors. Their priorities in descending order are described as follows:</p> <ol style="list-style-type: none"> 1. Built-in sensor: The GNSS data from this sensor enjoys the highest priority. 2. NMEA2000: If no valid GNSS data is from the built-in sensor or this sensor is disabled, the GNSS data from NMEA2000 will be used. 3. NMEA0183: If no valid GNSS data from both the build-in sensor and NMEA2000, the GNSS data from NMEA0183 will be used.
11	<p>In non scan mode: display CH NAME. In scan mode: SCAN ALL: indicates that the user selects SCAN ALL SCAN ALL+16: indicates that the user selects SCAN ALL+16 MEMORY SCAN: indicates that the user selects MEMORY SCAN MEMORY SCAN +16: indicates that the user selects MEMORY SCAN+16</p>
12 & 13	<p>Displays the current channel number.</p> <p> Note The first two digits in No.12. The last two digits in No. 13.</p>
14	<ul style="list-style-type: none"> - S : Indicates that the current channel is simplex. - D : Indicates that the current channel is duplex.
15	<ul style="list-style-type: none"> - INT: This icon appears if CH GROUP is INT. - USA: This icon appears if CH GROUP is USA - CAN: This icon appears if CH GROUP is CAN - WX: This icon appears if CH GROUP is USA or CAN, and WEATHER MODE is ON.

4. DIGITAL SELECTIVE CALLING

4.1 General

Digital Selective Calling (DSC) is a semi-automated method to establish a radio call. DSC has been designated by the International Maritime Organization (IMO) as an international standard for establishing VHF, MF and HF radio calls. It has also been designated as a part of the Global Maritime Distress and Safety System (GMDSS).

DSC replaces listening watches on distress frequencies and is used to broadcast routine and urgent maritime safety information broadcasts.

This system allows mariners to instantly transmit a distress call with GNSS position to the Coast Guard and other vessels within the range of the transmission. DSC also allows mariners to initiate or receive distress, urgency, safety, routine, position request, position transmit, and group calls to or from another vessel equipped with a DSC radio.

4.2 Maritime Mobile Service Identity

4.2.1 What Is an MMSI?

An MMSI is a nine-digit number used on marine radios capable of using DSC. This number is used like a telephone number to selectively call other vessels.

Note

To use the DSC functions, this vessel's MMSI must be entered into the radio.

4.2.2 How to Enter Your MMSI Number

Caution

An MMSI can be entered only once. Therefore, be careful not to enter the wrong MMSI number. If you need to change the MMSI number after it has been entered, contact your dealer.

Step 1 Press the **Menu/DSC** control until the "MAIN MENU" appears.

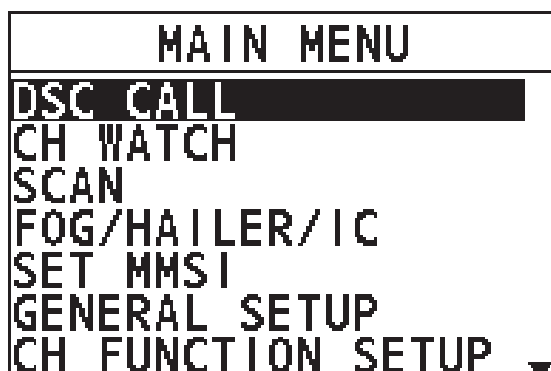

- Step 2 Go to "SET MMSI".
- Step 3 Enter your MMSI number (nine digits).
If you enter a wrong digit, press the **BACK** key until the wrong digit is selected, and then enter the correct digit.
- Step 4 After you enter the MMSI number, press the **Menu/DSC** control to save the number.
- Step 5 Enter the MMSI number again, and then press the **Menu/DSC** control to save the number.
If you enter a different digit that you entered at Step 3 and press the Menu/DSC control, automatically return to the Step 3.

4.3 DSC Distress Call

FM-4850 can send and receive DSC distress calls. When FM-4850 receives GNSS signals, FM-4850 can also transmit the latitude and longitude of the vessel together with the DSC distress call.

4.3.1 How to Initiate a DSC Distress Call

Note

To transmit a DSC distress call, this vessel's MMSI number must be entered into the radio. For information about how to enter the MMSI number, see section 4.2.2 How to Enter Your MMSI Number.

Initiate a DSC distress call without specifying the nature of distress

The FM-4850 can transmit a DSC distress call without specifying the following natural of distress categories: Undesignated, Fire, Flooding, Collision, Grounding, Listing, Sinking, Adrift, Abandoning, Piracy, and MOB (Man Overboard).

- Step 1 Open the cover labeled "DISTRESS".
- Step 2 Press and hold the **Distress** key (about 4 seconds). The unit beeps and the display shows the time remaining until the distress signal is sent.

After the distress signal is sent, the radio waits for an acknowledgement with the display showing "AWAIT ACK".

If no acknowledgement is received, the distress signal is repeated at 3.5-to-4.5-minute intervals, until a DSC acknowledgement is received.

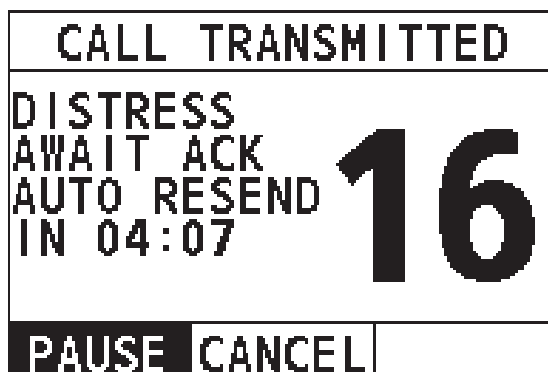

Step 3 When you receive the DSC acknowledgement, select "ACCEPT".

If the radio does not stay on CH16, you need to select "Accept".

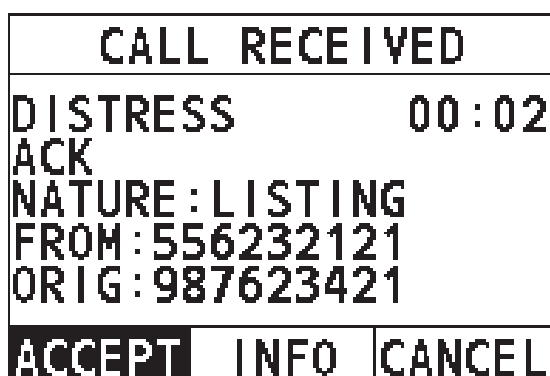

If the radio already stays on CH16, skip this step.

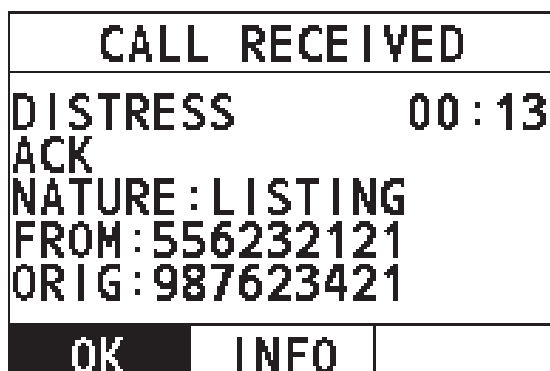

Step 4 Press and hold the PTT key to announce your situation on CH16.

Initiate a DSC distress call with the nature of distress specified

The FM-4850 is capable of transmitting a DSC distress call with the following distress categories: Undesignated, Fire, Flooding, Collision, Grounding, Listing,

Sinking, Adrift, Abandoning, Piracy, and MOB (Man Overboard).

- Step 1 Open the cover labeled "DISTRESS".
- Step 2 Short-press the **Distress** key.
The "DISTRESS" screen appears.
- Step 3 Select "NATURE".
The "NATURE" screen appears.
- Step 4 Select the nature of the distress.
- Step 5 Press and hold the **Distress** key (about 4 seconds). The unit beeps and the display shows the time remaining until the distress signal is sent.
After the distress signal is sent, the radio waits for an acknowledgement with the display showing "AWAIT ACK".
If no acknowledgement is received, the distress signal is repeated at 3.5-to-4.5-minute intervals, until a DSC acknowledgement is received.
- Step 6 When you receive the DSC acknowledgement, select "ACCEPT".
- Step 7 Press and hold the **PTT** key to announce your situation on CH16.

Initiate a DSC distress call with manually inputted position

If no position data is available at the time of distress, you can enter the latitude and longitude position of your vessel manually when you send a DSC distress call.

- Step 1 Open the cover labeled "DISTRESS".
- Step 2 Short-press the **Distress** key.
The "DISTRESS" screen appears.
- Step 3 Select "POS".
- Step 4 Rotate and press the **Menu/DSC** control to enter the latitude and longitude of your vessel and current UTC time in 24-hour format.
- Step 5 Press and hold the **Distress** key (about 4 seconds). The unit beeps and the display shows the time remaining until the distress signal is sent.
After the distress signal is sent, the radio waits for an acknowledgement with the display showing "AWAIT ACK".
If no acknowledgement is received, the distress signal is repeated at 3.5-to-4.5-minute intervals, until a DSC acknowledgement is received.
- Step 6 When you receive the DSC acknowledgement, select "ACCEPT".
- Step 7 Press and hold the **PTT** key to announce your situation on CH16.

Pause a DSC distress call

After a DSC distress call is sent, the DSC distress call is repeated at 3.5-to-4.5-minute intervals until the call is canceled by the user, until an acknowledgement is

received, or until the radio is turned off. The FM-4850 has a provision to pause the retransmitting of the distress call. To pause the distress call, select "PAUSE".

Restart the DSC distress call

After you select "PAUSE", the button is switched to "RESUME". At this time, you can select "RESUME" to restart the DSC distress call.

Sending a distress cancel call

When the emergency is released, you can cancel the distress call.

- Step 1 On the "CALL TRANSMITTED" page, select "CANCEL".
- Step 2 Select "YES".
- Step 3 Select "OK".
- Step 4 Press and hold the **PTT** key to announce your situation.

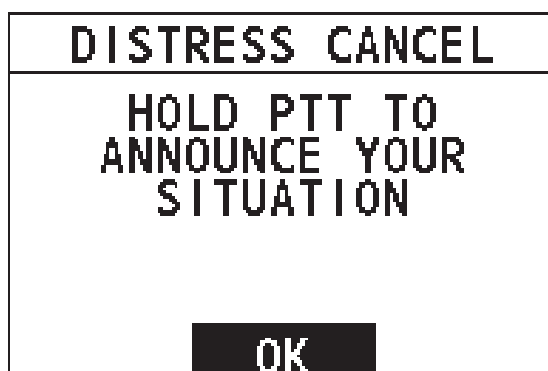

All stations. (Repeat 3 times)

This is (Own ship name & call sign).

MMSI 123456789

Our position is 09°12.1234' N, 123°45.1234' E.

Cancel my DISTRESS ALERT

in 10/apr/2012 12:34

- Step 5 Select "OK" to return to the home screen.

4.3.2 How to Receive a DSC Distress Call

- Step 1 When a DSC distress call is received, the emergency alarm sounds. Rotate the **Menu/DSC** control to stop the alarm.

Step 2 Optional: The display shows the MMSI of the vessel in distress. To show additional information of the vessel in distress, select "INFO", and then select "OK".

Step 3 To accept the distress call, select "ACCEPT".

The radio switches to CH16 automatically.

 **Note**

If you press "CANCEL", the radio quits the automatic switching to CH16 and reverts to the last selected working channel.

Step 4 Listen on CH16 for five minutes.

4.4 Individual Call

This feature allows you to contact a vessel with the DSC feature.

 **Caution**

To make a DSC individual call, the radio of the receiving party should be set to manually acknowledge the individual call request from the initiating party. Otherwise, the radio of the receiving party will automatically send an "unable to acknowledge" message and the individual call cannot be established. For information about how to set it, see 12.4 Individual Acknowledgement.

4.4.1 How to Initiate an Individual Call

Enter the individual call page

Step 1 On the home screen, press the **Menu/DSC** control to enter the "MAIN MENU" screen.

Step 2 Go to "DSC CALL > INDIVIDUAL".
The "INDIVIDUAL" page appears on the screen.

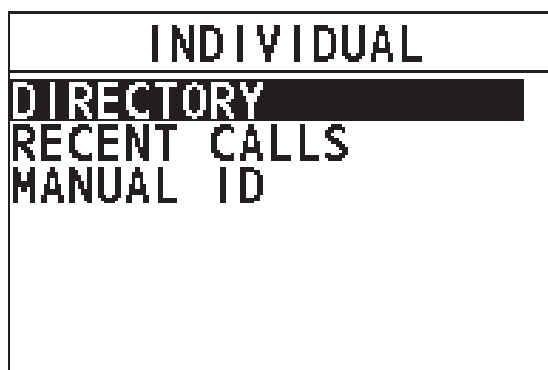

Initiate an individual call to a vessel registered in the individual directory

Before you initiate an individual call from the individual directory, a vessel or

person's name and the MMSI number associated with the vessel you want to transmit the call should be added to the individual directory. For information about how to add entries to individual directory, see section 12.1.1 Adding an Entry.

- Step 1 On the "INDIVIDUAL" page, select "DIRECTORY".
- Step 2 Select an individual contact, and then press the **Menu/DSC** control to enter the "SELECT CH" page.
- Step 3 Select a channel.
- Step 4 Press the **Menu/DSC** control to initiate an individual call.
- When CH70 is busy, you can wait without pressing any key until CH70 is idle.
 - When the CH70 is idle, the following screens appear, and the radio waits for an acknowledgement.
 - Icon indicates the alias of the contact. If the called party is added in the call list, the alias will appear here.

CALL TRANSMITTED			CALL TRANSMITTED		
SENDING INDIVIDUAL ICON			INDIVIDUAL 00:02 CATEGORY:ROUTINE TO:ICON REQUEST CH:09 AWAIT ACK		
			RESEND	CANCEL	

- Step 5 When the radio receives an acknowledgement, an alarm sounds and the working channel changes to the channel selected in Step 3. Select "OK" on the screen.
- Step 6 Press and hold the **PTT** key to talk into the handset.

Initiate an individual call from the "RECENT CALLS"

- Step 1 On the "INDIVIDUAL" page, select "RECENT CALLS".
- Step 2 Select an individual contact, and then press the **Menu/DSC** control to enter the "SELECT CH" page.
- Step 3 Select a channel.
- Step 4 Press the **Menu/DSC** control to initiate an individual call.
- When CH70 is busy, you can wait without pressing any key until CH70 is idle. "A1" indicates the alias of called party. If the called party has no alias, the MMSI of called party will appear.
 - When the CH70 is idle, the radio waits for an acknowledgement.

- Step 5 When the radio receives an acknowledgement, an alarm sounds and the working channel changes to the channel selected in Step 3. Select "OK" on the screen.
- Step 6 Press and hold the **PTT** key to talk into the handset.

Initiate an individual call by manually entering an MMSI number

- Step 1 On the "INDIVIDUAL" page, select "MANUAL ID".
- Step 2 Enter the MMSI of your desired individual contact, and then press the **Menu/DSC** control to enter the "SELECT CH" page.
- Step 3 Select a channel.
- Step 4 Press the **Menu/DSC** control to initiate an individual call.
- When CH70 is busy, you can wait without pressing any key until CH70 is idle.
 - When the CH70 is idle, the radio waits for an acknowledgement.
- Step 5 When the radio receives an acknowledgement, an alarm sounds and the working channel changes to the channel selected in Step 3. Select "OK" on the screen.
- Step 6 Press and hold the **PTT** key to talk into the handset.

4.4.2 How to Receive an Individual Call

The channel change of your radio has two modes: "AUTO" and "MANUAL". When you select "AUTO", the radio automatically switch to the designated channel after 10 seconds without user intervention. When selecting "MANUAL", you need to manually change the channel. For information about how to set the channel change mode, see section 12.3 Channel Change Mode.

When the channel change mode is "AUTO"

- Step 1 When an individual call is received, the alarm sounds. Rotate the **Menu/DSC** control to stop the alarm.
The radio screen shows the MMSI of the calling vessel and three soft keys: "ACCEPT", "REJECT", and "PAUSE". If the requested channel cannot comply, the screen only shows two soft keys: "REJECT" and "CANCEL".

CALL RECEIVED	
INDIVIDUAL	00:00
CATEGORY: ROUTINE	
FROM: 333456789	
REPLY ON CH71[10]	
CURRENT CH: 16	
ACCEPT	REJECT
PAUSE	

- **ACCEPT:** Select the soft key to continue with the call and switch to the requested channel.
- **REJECT:** Select the soft key to reject the call. After you select "REJECT", the following screen appears. Select a reason for rejecting the call, and then an "UNABLE ACK" message is sent. After the message is sent, the radio returns to the home screen and the channel remains unchanged.

REJECT	
NO REASON	
BUSY	
QUEUE	
BARRED	
NO OPERATOR	
UNAVAILABLE	
DISABLE	

- **PAUSE:** Select the soft key to pause the call and timing and temporarily disable automatic switching to the requested channel. You can resume the call by pressing the "RESUME" soft key.

Step 2 Select "ACCEPT".

- When CH70 is busy, you can wait without pressing any key until CH70 is idle.
- When CH70 is idle, the radio sends an acknowledgement and the requested channel is selected, ready for a conversation.

Note

If no key is pressed within 10 seconds, the radio automatically sends an acknowledgement and switches to the requested channel when CH70 is idle. Otherwise, the radio will wait until CH70 is idle.

Step 3 Press and hold the **PTT** key to talk into the handset.

When the channel change mode is "MANUAL"

- Step 1 When an individual call is received, the alarm sounds. Rotate the **Menu/DSC** control to stop the alarm. The following screen appears. The screen shows the MMSI of the vessel calling and three soft keys: "ACCEPT", "REJECT", and "CANCEL". If the requested channel cannot comply, the screen only shows two soft keys: "REJECT" and "CANCEL".

CALL RECEIVED		
INDIVIDUAL	00:04	
CATEGORY: ROUTINE		
FROM: 333456789		
REPLY ON CH 71		
CURRENT CH: 16		
ACCEPT	REJECT	CANCEL

- **ACCEPT:** Select the soft key to continue with the call and switch to the requested channel.
- **REJECT:** Select the soft key to reject the call. After you select "REJECT", select a reason for rejecting the call, and then an "UNABLE ACK" message is sent. After the message is sent, the radio returns to the home screen and the channel remains unchanged.
- **CANCEL:** Select the soft key and then the radio returns to the home screen and the channel remains unchanged.

- Step 2 Select "ACCEPT".

Note

When CH70 is busy, the radio will wait until CH70 is idle.

Then the radio sends an acknowledgement and the requested channel is selected, ready for a conversation.

- Step 3 Press and hold the **PTT** key to talk into the handset.

4.5 Group Call

This feature allows you to contact a group of specific vessels (for example, members of a yacht club) using DSC radios that have a group call function. When a group call is sent, all DSC radios in the group automatically switch to the channel specified in the call to prepare for voice communications. This feature is useful for yacht clubs and vessels traveling together that want to collectively make announcements on a predetermined channel. Up to 40 group call MMSIs can be programmed.

4.5.1 How to Initiate a Group Call

Enter the group call page

- Step 1 On the home screen, press the **Menu/DSC** control to enter the "MAIN MENU" screen.
- Step 2 Go to "DSC CALL > GROUP".
The "GROUP" page appears on the screen.

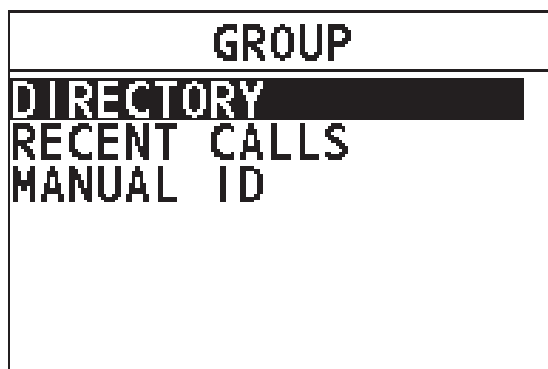

Register a group call

- Step 1 On the home screen, press the **Menu/DSC** control to enter the "MAIN MENU" screen.
- Step 2 Go to "DSC SETUP > GROUP DIRECTORY".

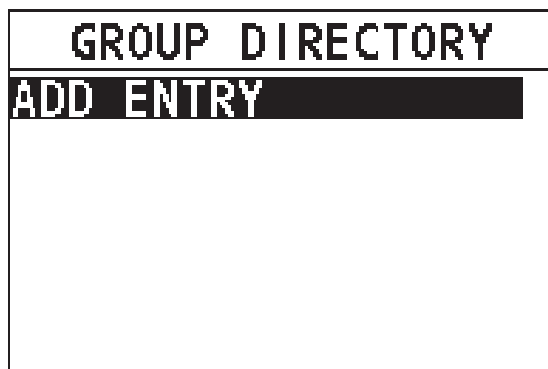

- Step 3 Select "ADD ENTRY" to register a group.
- Step 4 Rotate and press the **Menu/DSC** control to enter a new group name and MMSI.

The maximum of entries is 40.

Initiate a group call to a group registered in the directory

- Step 1 On the "GROUP" page, select "DIRECTORY".
- Step 2 Select a group, and then press the **Menu/DSC** control to enter the "SELECT CH" page.

- Step 3 Select a channel.
- Step 4 Press the **Menu/DSC** control to initiate a group call.
- When CH70 is busy, you can wait without pressing any key until CH70 is idle.
 - When the CH70 is idle, the radio waits for an acknowledgement.
- Step 5 Select "OK" to return to the home screen.
- Step 6 Press and hold the **PTT** key to talk into the handset.

Initiate a group call from the "RECENT CALLS"

- Step 1 On the "GROUP" page, select "RECENT CALLS".
- Step 2 Select a group, and then press the **Menu/DSC** control to enter the "SELECT CH" page.
- Step 3 Select a channel.
- Step 4 Press the **Menu/DSC** control to initiate a group call.
- When CH70 is busy, you can wait without pressing any key until CH70 is idle.
 - When the CH70 is idle, the radio waits for an acknowledgement.
- Step 5 Select "OK" to return to the home screen.
- Step 6 Press and hold the **PTT** key to talk into the handset.

Initiate a group call by manually entering a group ID

- Step 1 On the "GROUP" page, select "MANUAL ID".
- Step 2 Select a group, and then press the **Menu/DSC** control to enter the "SELECT CH" page.
- Step 3 Select a channel.
- Step 4 Press the **Menu/DSC** control to initiate a group call.
- When CH70 is busy, you can wait without pressing any key until CH70 is idle.
 - When the CH70 is idle, the radio waits for an acknowledgement.
- Step 5 Select "OK" to return to the home screen.
- Step 6 Press and hold the **PTT** key to talk into the handset.

4.5.2 How to Receive a Group Call

The channel change of your radio has two modes: "AUTO" and "MANUAL". Different channel change modes lead to different operations when you receive an All Ships call. For information about how to set the channel change mode, see section 12.3 Channel Change Mode.

When the channel change mode is "AUTO"

Step 1 When a DSC Distress Alert is received, the alarm sounds. Rotate the **Menu/DSC** control to stop the alarm.

The screen shows the MMSI of the vessel calling and three soft keys: "ACCEPT", "REJECT", and "PAUSE".

- ACCEPT: Select the soft key to continue with the call and switch to the requested channel.
- REJECT: Select the soft key to cancel the automatic channel switching. The radio returns to the home screen and the channel remains unchanged.
- PAUSE: Select the soft key to pause the call and timing. You can resume the call by pressing the "RESUME" soft key.

CALL RECEIVED		
GROUP	00:01	
CATEGORY: ROUTINE		
FROM: 144456789		
REPLY ON CH68[9]		
CURRENT CH:09		
ACCEPT	REJECT	PAUSE

Step 2 Select "ACCEPT" to switch to the requested channel.

Note

If no key is pressed within 10 seconds, the radio automatically switches to the requested channel.

Step 3 Press and hold the **PTT** key to talk into the handset.

When the channel change mode is "MANUAL"

Step 1 When a DSC Distress Alert is received, the alarm sounds. Rotate the **Menu/DSC** control to stop the alarm.

The screen shows the MMSI of the vessel calling and two soft keys: "ACCEPT" and "PAUSE".

- ACCEPT: Select the soft key to continue with the call and switch to the requested channel.
- Cancel: Select the soft key to cancel the call. The radio returns to the home screen and the channel remains unchanged.

CALL RECEIVED	
GROUP	00:17
CATEGORY: ROUTINE	
FROM: 144456789	
REPLY ON CH 68	
CURRENT CH: 06	
ACCEPT	CANCEL

Step 2 Select "ACCEPT" to switch to the requested channel.

Step 3 Press and hold the **PTT** key to talk into the handset.

4.6 All Ships Call

This feature allows you to initiate a safety call or an urgency call to DSC-equipped vessels without having their MMSIs in the directory or receive a safety call or an urgency call.

- **Safety call:** This type of call is used to transmit safety information (for example, an overdue boat, debris in the water, loss of a navigation aid, and an important meteorological message) to other vessels. This call is the same as saying "Security, Security, Security".
- **Urgency call:** This type of call is used when a vessel may not truly be in distress, but has a potential problem that may lead to a distress situation. This call is the same as saying "Pan-Pan-Pan" on CH16.

4.6.1 How to Initiate an All Ships Call

Step 1 On the home screen, press the **Menu/DSC** control to enter the "MAIN MENU" on the screen.

Step 2 Go to "DSC CALL > ALL SHIPS".
The "ALL SHIPS" page appears on the screen.

ALL SHIPS	
SAFETY	[REDACTED]
URGENCY	

Step 3 Select the category of the call ("SAFETY" or "URGENCY").

Step 4 Select a channel.

- Step 5 Press the **Menu/DSC** control to initiate a group call.
- When CH70 is busy, you can wait without pressing any key until CH70 is idle.
 - When CH70 is idle, the All Ships call is transmitted, and the radio switches to the selected channel.

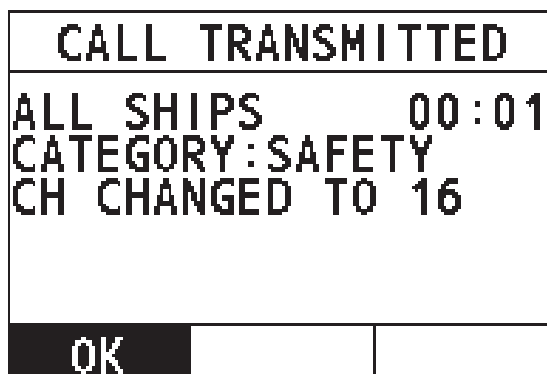

- Step 6 Select "OK" to return to the home screen.
- Step 7 Press and hold the **PTT** key to talk into the handset.

4.6.2 How to Receive an All Ships Call

The channel change of your radio has two modes: "AUTO" and "MANUAL". Different channel change modes lead to different operations when you receive an All Ships call. For information about how to set the channel change mode, see section 12.3 Channel Change Mode.

When the channel change mode is "AUTO"

- Step 1 When an All Ships call is received, an emergency alarm sounds. Rotate the **Menu/DSC** key to stop the alarm. The following screen appears. The screen shows the MMSI of the vessel calling and three soft keys: "ACCEPT", "REJECT", and "PAUSE". If the requested channel cannot comply, the screen only shows the "REJECT" soft key.

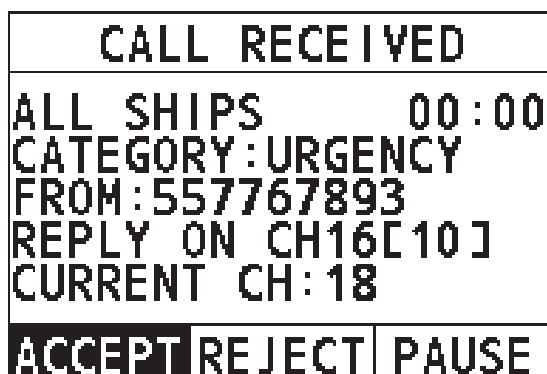

- **ACCEPT**: Select the soft key to continue with the call and switch to the requested channel.

- **REJECT:** Select the soft key to cancel the automatic channel switching. The radio returns to the home screen and the channel remains unchanged.
- **PAUSE:** Select the soft key to pause the call and timing and temporarily disable automatic switching to the requested channel. You can resume the call by pressing the "RESUME" soft key.



Note

If no key is pressed within 10 seconds, the radio automatically switches to the requested channel. After 10 seconds, the countdown appears next to "REPLY ON CH16".

[10] indicates that the 10 seconds countdown appears next to "REPLY ON CH16".

- Step 2 Select "ACCEPT" to continue with the call.
The radio monitors the reply on channel until the All Ships call is completed.

When the channel change mode is "MANUAL"

- Step 1 When an All Ships call is received, an emergency alarm sounds. Press any key to stop the alarm.
The following screen appears. The screen shows the MMSI of the vessel calling and two soft keys: "ACCEPT" and "CANCEL". If the requested channel cannot comply, the screen only shows the "CANCEL" soft key.



- **ACCEPT:** Select the soft key to continue with the call and switch to the requested channel.
 - **CANCEL:** Select the soft key and then the radio returns to the home screen and the channel remains unchanged.
- Step 2 Select "ACCEPT" to continue with the call.
The radio monitors the requested channel until the All Ships call is completed.

4.7 Position Request Call

The radio with DSC the feature can poll the location of another vessel and show the

position of that vessel on the radio screen.

4.7.1 How to Initiate a Position Request Call

Enter the position request page

- Step 1 On the home screen, press the **Menu/DSC** control to enter the "MAIN MENU" page on the screen.
- Step 2 Go to "DSC CALL > POS REQUEST".
The "POS REQUEST" page appears on the radio screen.

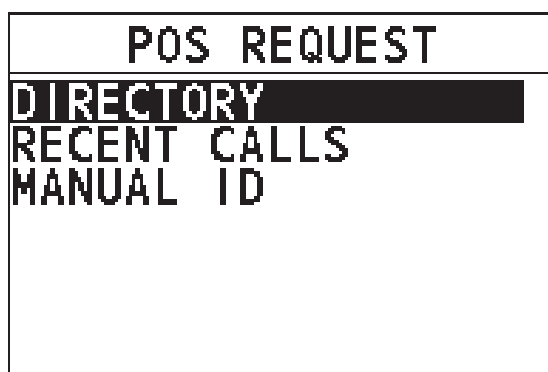

Initiate a position request call to a vessel registered in the directory

Before you initiate a position request call from the individual directory, a vessel or person's name and the MMSI number associated with the vessel you want to transmit the call should be added to the individual directory. For information about how to add entries to individual directory, see section 12.1.1 Adding an Entry.

- Step 1 On the "POS REQUEST" page, press the **Menu/DSC** control to select "DIRECTORY".
- Step 2 Select an individual contact, and then press the **Menu/DSC** control.
- When CH70 is busy, you can wait without pressing any key until CH70 is idle.
 - When the CH70 is idle, the radio waits for an acknowledgement.
- Step 3 When the radio receives an acknowledgement, the radio screen shows the requested position information. Select the "OK" soft key or the **Back** key to return to the home screen.

CALL RECEIVED	
POS ACK	00:03
FROM: I CON	
LAT : 22° 41.451N	
LON : 114° 17.590E	
TIME: 03:31 UTC	
OK	

 **Note**

If you receive an ACK from a ship that does not have location information, it would be easier to understand that it is expressed as "NO INFO" rather than "receive false position information".

CALL RECEIVED	
POS ACK	00:04
FROM: I CON	
NO INFO	
NO INFO	
NO INFO	
OK	

Initiate a position request call from the "RECENT CALLS"

- Step 1 On the "POS REQUEST" page, select "RECENT CALLS".
- Step 2 Select an individual contact, and then press the **Menu/DSC** control.
- When CH70 is busy, you can wait without pressing any key until CH70 is idle.
 - When the CH70 is idle, the following screens appear, and the radio waits for an acknowledgement.
- Step 3 When the radio receives an acknowledgement, the radio screen shows the requested position information. Select the "OK" soft key or the **Back** key to return to the home screen.

 **Note**

If you receive an ACK from a ship that does not have location information, it would be easier to understand that it is expressed as "NO INFO" rather than "receive false position information".

CALL RECEIVED		
POS ACK		00:04
FROM: I CON		
NO INFO		
NO INFO		
NO INFO		
OK		

Initiate position request call by manually entering an MMSI number

- Step 1 On the "POS REQUEST" page, select "MANUAL ID".
- Step 2 Rotate and press the **Menu/DSC** control to enter the MMSI of an individual contact, and then press the **Menu/DSC** control.
- When CH70 is busy, you can wait without pressing any key until CH70 is idle.
 - When the CH70 is idle, the radio waits for an acknowledgement.
- Step 3 When the radio receives an acknowledgement, the radio screen shows the requested position information. Select the "OK" soft key or the **Back** key to return to the home screen.

Note

If you receive an ACK from a ship that does not have location information, it would be easier to understand that it is expressed as "NO INFO" rather than "receive false position information".

CALL RECEIVED		
POS ACK		00:04
FROM: 123456789		
NO INFO		
NO INFO		
NO INFO		
OK		

4.7.2 How to Receive a Position Request Call

The "POSITION ACK" has three options: "MANUAL", "AUTO", and "IGNORE". For information about how to set the "POSITION ACK", see section 12.5 Position Acknowledgement. When "POSITION ACK" is set to "IGNORE", your radio has no

response or log. When it is set to other values, do as follows.

When "POSITION ACK" is set to "MANUAL"

- Step 1 When a DSC position request call is received, the alarm sounds. Rotate the **Menu/DSC** control to stop the alarm.
- Step 2 Select "REPORT" to send your position.

CALL RECEIVED	
POSITION	00:03
REQUEST	
CATEGORY: SAFETY	
FROM: 433456789	
REPORT	CANCEL

- When CH70 is busy, you can wait without pressing any key until CH70 is idle.
- When CH70 is idle, the radio sends an acknowledgement and the position is transmitted.

- Step 3 After the position is transmitted, select "OK" to return to the home screen.

CALL TRANSMITTED	
POSITION	00:02
REPORT	
CATEGORY: SAFETY	
TO: 433456789	
OK	

When "POSITION ACK" is set to "AUTO"

When a DSC position request call is received, the radio automatically sends the position information to the requested radio.

Note

When CH70 is busy, you can wait without pressing any key until CH70 is idle. Then the radio automatically sends the position information. Select "OK" to return to the home screen.

4.8 Auto Position Polling

This feature allows FM-4850 to automatically send a position request call at certain intervals.

This feature must first be enabled from the "ACTIVATION" menu, then the vessel addresses must be set from the "SELECT ADDRESS" menu.

Also, you can monitor the position of the selected vessel from the "MONITOR POSITION" menu.

4.8.1 How to Enable the Auto Position Polling

Step 1 On the home screen, press the **Menu/DSC** control to enter the "MAIN MENU" screen.

Step 2 Go to "DSC CALL > AUTO POS POLLING".
The "AUTO POS POLLING" page appears on the screen.

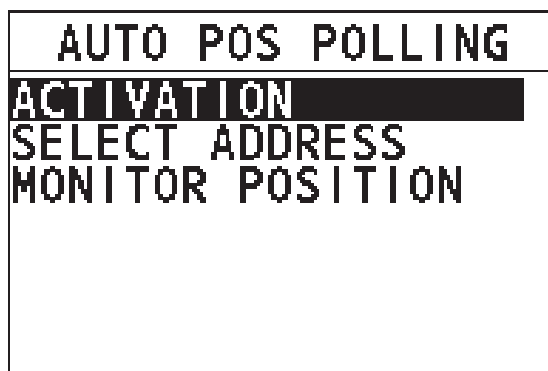

Step 3 Select "ACTIVATION".
The "ACTIVATION" page appears on the screen. The screen shows two soft keys: "START" and "STOP".

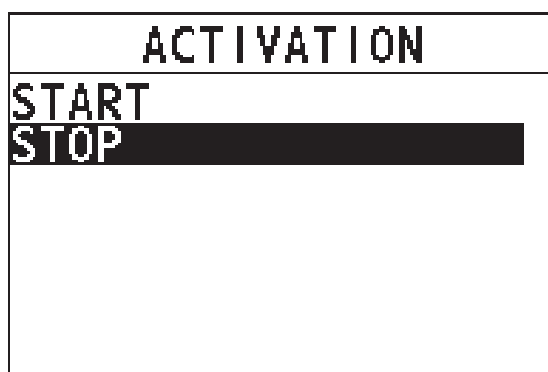

- **START:** Select the soft key to start automatic position polling. If there is no address to poll, the radio rings the wrong beep.
- **STOP:** Select the soft key to stop automatic position polling.

Step 4 Select "START" to activate the automatic position polling.
The radio returns to the previous screen.

4.8.2 How to Select Vessels to Which the Radio Sends Auto Position Request Calls

- Step 1 On the home screen, press the **Menu/DSC** control to enter the "MAIN MENU" screen.
- Step 2 Go to "DSC CALL > AUTO POS POLLING".
The "AUTO POS POLLING" page appears on the screen.
- Step 3 Select "SELECT ADDRESS".
The "SELECT ADDRESS" page appears on the screen.
You can add at most four directories.

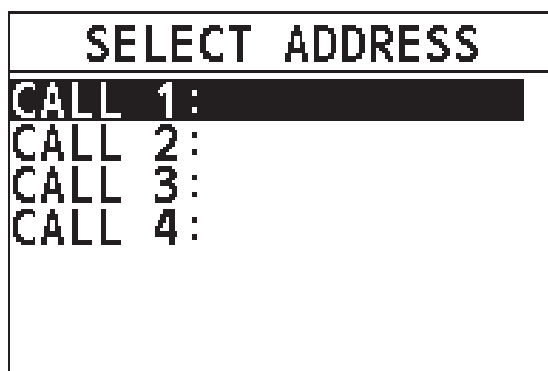

- Step 4 Select a directory.



Note

You need to select at least one directory first to start the auto position polling.

4.8.3 How to Monitor Position

After you enable the Auto Position Polling feature, you can monitor the position.

- Step 1 On the home screen, press the **Menu/DSC** control to enter the "MAIN MENU" screen.
- Step 2 Go to "DSC CALL > AUTO POS POLLING".
The "AUTO POS POLLING" page appears on the screen.
- Step 3 Select "MONITOR POSITION".
The "MONITOR POSITION" page appears on the screen. "A0-A3" indicated the alias.

MONITOR POSITION	
1:A1	12:34
2:A2	--:--
3:A3	--:--
4:A4	--:--

- Step 4 Select a directory to view the latest position information of the corresponding vessel.
If the radio does not receive an acknowledgement, the display shows the following page.

MONITOR POSITION	
POSITION REQUEST TO:A0 AWAIT ACK	
OK	

- Step 5 Select "OK" to return to the previous screen.

4.9 DSC Log

This feature allows the FM-4850 to record calls for review.

A icon appears in the log to indicate an unread received call message. The FM-4850 can store logs for the latest 40 received distress calls, the latest 10 received position request calls, the latest 40 received other calls, the latest 40 transmitted calls, and the latest 10 transmitted acknowledges.

The "RX POS REQ LOG" and "TX ACK LOG" are cleared each time the equipment is restarted.

To view a log, do as follows:

- Step 1 On the home screen, press the **Menu/DSC** control to enter the "MAIN MENU" screen.
- Step 2 Select "DSC CALL".
- Step 3 Select "DSC LOG" to enter the "DSC LOG" page on the screen.
- Step 4 Select the DSC log type you want to view.

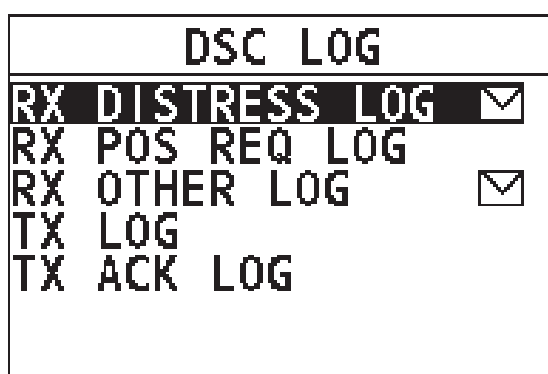

- Step 5 Select a log you want to view.
You can initiate the call again or delete the log by pressing the "CALL" or "DELETE" soft key on the screen.

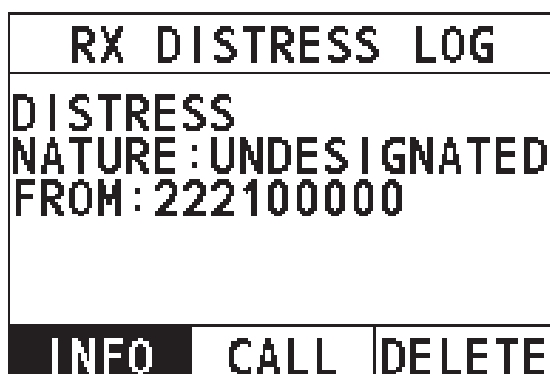

4.10 DSC Test

This feature allows you to test whether your DSC radio can communicate normally with another DSC radio. To use this feature, the radio that you send the test call to must have the DSC Test feature.

Note

To make a DSC test call, this vessel's MMSI number must be entered into the radio. For information about how to enter the MMSI number, see section 4.2.2 How to Enter Your MMSI Number.

Enter the DSC test page

- Step 1 On the home screen, press the **Menu/DSC** control to enter the "MAIN MENU" screen.
- Step 2 Select "DSC CALL".
- Step 3 Select "DSC TEST" to enter the "DSC TEST" page on the screen, as shown below.

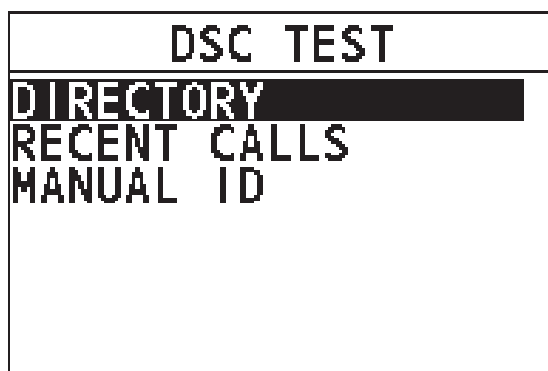

Initiate a DSC test call to a vessel registered in the individual directory

Before you initiate a DSC test call from the individual directory, a vessel or person's name and the MMSI number associated with the vessel you want to transmit the call to should be added to the individual directory. For information about how to add entries to individual directory, see section 12.1.1 Adding an Entry.

- Step 1 On the "DSC TEST" page, select "DIRECTORY".
- Step 2 Select an individual contact.

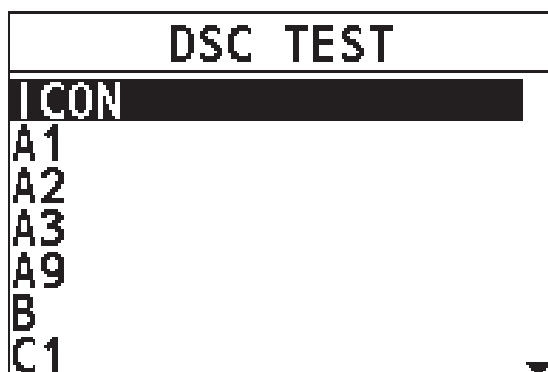

- Step 3 Press the **Menu/DSC** control to send the DSC test call.
Your radio waits for an acknowledgement from the radio you called.

CALL TRANSMITTED			CALL TRANSMITTED		
SENDING...			TEST CALL 00:02		
TEST CALL			TO: ICON		
ICON			AWAIT ACK		
			RESEND	CANCEL	

Step 4 When the radio receives an acknowledgement, an alarm sounds and the following page appears. It means the radio you called has received the call. Select "OK" to return to the previous screen.

CALL RECEIVED		
TEST		00:03
ACK		
CATEGORY: SAFETY		
FROM: ICON		
OK		

Initiate a DSC test call from the "RECENT CALLS"

Step 1 On the "DSC TEST" page, select "RECENT CALLS".

Step 2 Select an individual contact.

DSC TEST	
ICON	
A0	114000000
A1	113000000

Step 3 Press the **Menu/DSC** control to send the DSC test call. Your radio waits for an acknowledgement from the radio you called.

Step 4 When the radio receives an acknowledgement, an alarm sounds. It means the radio you called has received the call. Select "OK" to return to the previous screen.

Initiate a DSC test call by manually entering an MMSI number

- Step 1 On the "DSC TEST" page, rotate and press the **Menu/DSC** control to select "MANUAL ID".
- Step 2 Rotate and press the **MENU/DSC** control to enter the MMSI of a vessel that you want to contact.

DSC TEST
ENTER MMSI : 987623421
PRESS MENU/DSC KNOB

- Step 3 Press the **Menu/DSC** control to send the DSC test call. Your radio waits for an acknowledgement from the radio you called.
- Step 4 When the radio receives an acknowledgement, an alarm sounds . It means the radio you called has received the call. Select "OK" to return to the previous screen.

5. CHANNEL WATCH

5.1 Dual Channel

Dual channel scans two channels for communications. One channel is a normal VHF channel and the other is CH16. The following is how the DUAL CH feature works when a signal is received on one of the channel:

- If a signal is received on the normal channel, the radio quickly switches between the normal channel and CH16 to look for a transmission.
- If a signal is received on CH16, the radio stops and listens only to CH16 until communication ends and then starts DUAL CH scan again.

- Step 1 Press and rotate the **Volume/Squelch** control to adjust the squelch until the background noise disappears.
- Step 2 On the home screen, rotate the **Menu/DSC** control to select a channel to DUAL CH with CH16.
- Step 3 Press the **Menu/DSC** control to enter the "MAIN MENU" page.
- Step 4 Select "CH WATCH".

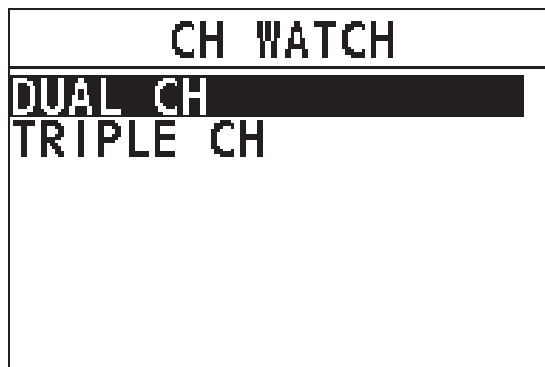

- Step 5 Select "DUAL CH".
The radio returns to the home screen. The display alternately scans between CH16 and the channel that is selected in step 2.
- Step 6 To stop DUAL WATCH, press the **Back** key or the **Menu/DSC** control.

5.2 Triple Channel

Triple channel scans three channels for communications: CH16, the second priority channel, and a normal VHF channel. The following is how the TRIPLE CH feature works:

- If a signal is received on the normal channel, the radio quickly switches among the normal channel, second priority channel, and CH16 to look for a transmission.

- If a signal is received on CH16, the radio stops and listens only to CH16 until communication ends and then starts TRIPLE CH scan again.

For information about how to set the second priority channel, see section 11.2 Second Priority Channel.

- Step 1 Press and rotate the **Volume/Squelch** control to adjust the squelch until the background noise disappears.
- Step 2 On the home screen, rotate the **Menu/DSC** control to select a channel to watch with CH16 and the second priority channel.
- Step 3 Press the **Menu/DSC** control to enter the "MAIN MENU" page.
- Step 4 Select "CH WATCH".
- Step 5 Select "TRIPLE CH"
- The radio returns to the home screen. The display alternately scans among CH16, the second priority channel, and the channel that is selected in step 2.
- Step 6 To stop TRIPLE CH, press the **Back** key or the **Menu/DSC** control.

6. SCAN

This feature allows you to select a scan mode to find the broadcasting channels. The available scan modes are as follows: SCAN ALL, SCAN ALL + 16, MEMORY SCAN, and MEMORY SCAN + 16.

6.1 Scan All

Scan All mode scans all channels in sequence.

- Step 1 On the home screen, press the **Menu/DSC** control to enter the "MAIN MENU" screen.
- Step 2 Go to "SCAN > SCAN ALL".
The radio starts to scan all channels.
- Step 3 To stop scanning, press the **Back** key or the **Menu/DSC** control.

6.2 Scan All + 16

Scan All + 16 mode scans all channels in sequence, and checks CH16 between two channels.

- Step 1 On the home screen, press the **Menu/DSC** control to enter the "MAIN MENU" screen.
- Step 2 Go to "SCAN > SCAN ALL+16".
The radio starts to scan all channels in sequence, and checks CH16 after each programmed channel.
- Step 3 To stop scanning, press the **Back** key or the **Menu/DSC** control.

6.3 Memory Scan

Memory Scan mode scans all memory channels in sequence.

Note

Before you enable the Memory Scan mode, at least two channels should be set as memory channels. For information about how to set memory channels, see section 6.5 Editing Memory Channel List.

- Step 1 On the home screen, press the **Menu/DSC** control to enter the "MAIN MENU" screen.
- Step 2 Go to "SCAN > MEMORY SCAN".
The radio starts to scan all memory channels in sequence.
- Step 3 To stop scanning, press the **Back** key or the **Menu/DSC** control.

6.4 Memory Scan + 16

Memory Scan + 16 mode scans all memory channels in sequence, and checks CH16 after each programmed channel.

Note

Before you enable the Memory Scan +16 mode, at least one channel should be set as the memory channel. For information about how to set memory channels, see section 6.5 Editing Memory Channel List.

- Step 1 On the home screen, press the **Menu/DSC** control to enter the "MAIN MENU" screen.
- Step 2 Go to "SCAN > MEMORY SCAN+16".
The radio starts to scan all memory channels in sequence, and checks CH16 after each memory channel.
- Step 3 To stop scanning, press the **Back** key or the **Menu/DSC** control.

6.5 Editing Memory Channel List

This feature allows you to add channels to or remove channels from the memory channel list. Channels in the memory channel list are what the Memory Scan mode scans.

How to add all channels to the memory channel list

- Step 1 On the home screen, press the **Menu/DSC** control to enter the "MAIN MENU" screen.
- Step 2 Go to "SCAN > EDIT MEMORY CH > SELECT ALL".
"MEM" icons appear after each channel number.

EDIT MEMORY CH	EDIT MEMORY CH
SELECT ALL	ALL OFF
01	01 MEM
02	02 MEM
03	03 MEM
04	04 MEM
05	05 MEM
06	06 MEM

- Step 3 Press the **Back** key to return to the previous screen.

How to remove all channels from the memory channel list

When all programmed channels are added to the memory channel list, you can do as follows to remove all channels from the list.

- Step 1 On the home screen, press the **Menu/DSC** control to enter the "MAIN MENU" screen.
- Step 2 Go to "SCAN > EDIT MEMORY CH > ALL OFF".
"MEM" icons disappear on the display.
- Step 3 Press the **Back** key to return to the previous screen.

How to add a channel to the memory channel list

- Step 1 On the home screen, press the **Menu/DSC** control to enter the "MAIN MENU" screen.
- Step 2 Select "SCAN > EDIT MEMORY CH".
- Step 3 Select a channel to be scanned.
- Step 4 Press the **Menu/DSC** control to set the channel to a memory channel.
The "MEM" icon appears on the display.
- Step 5 Press the **Back** key to return to the previous screen.

How to remove a channel from the memory channel list

- Step 1 On the home screen, press the **Menu/DSC** control to enter the "MAIN MENU" screen.
- Step 2 Select "SCAN > EDIT MEMORY CH".
- Step 3 Rotate the **Menu/DSC** control to select a channel to be removed from the memory channel list.
- Step 4 Press the **Menu/DSC** control to remove the channel from the memory channel list.
The "MEM" icon disappears on the display.
- Step 5 Press the **Back** key to return to the previous screen.

7. Weather Mode

When the product works on the USA or CAN channel, the weather mode is enabled. In this case, you can monitor the weather report from National Oceanographic and Atmospheric Administration (NOAA). For information about how to select a Channel Group (USA or Canada), see section 11.1.

Weather mode

Step 1 Press the Menu/DSC control until the "MAIN MENU" screen appears.

Step 2 Select "WEATHER MODE".

The weather mode page appears on the screen.

☁: indicates weather alert is ON.

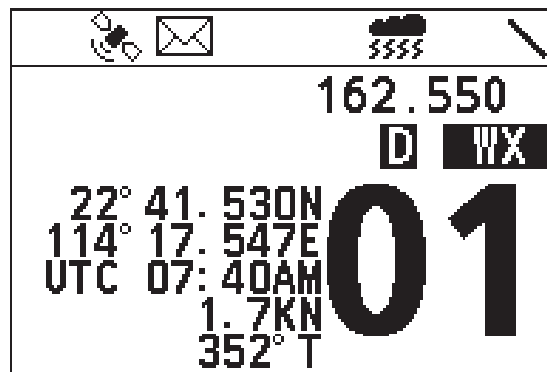

In weather mode, you can rotate the Menu/DSC to select a NOAA channel to monitor. What you selected would be marked as last used weather channel.

NOAA weather alert

In the event of extreme weather disturbances, such as storms and hurricanes, the NOAA sends a weather alert accompanied by a 1050 Hz tone and subsequent weather report on one of the NOAA weather channels.

Step 1 Press the **Menu/DSC** control until the "MAIN MENU" screen appears.

Step 2 Select "GENERAL SETUP >WEATHER ALERT".



- Step 3 Select ON or OFF to enable or disable the feature.
- Step 4 Press the **Menu/DSC** control to save the setting and return to the previous page.

8. Fog Horn/Hailer/Intercom

Note

When receiving DSC calls in the Fog Horn mode or the Hailer mode, the radio exits the Fog Horn mode or the Hailer mode and enters the call receiving page.

8.1 Fog Horn

This feature sounds certain international standard fog horn tones through the speaker. This feature is available only when the radio is connected to a hailer.

Enter the "FOG HORN" page

- Step 1 On the home screen, press the **Menu/DSC** control to enter the "MAIN MENU" screen.
- Step 2 Go to "FOG/HAILER/IC > FOG HORN".
The "FOG HORN" page appears on the screen.

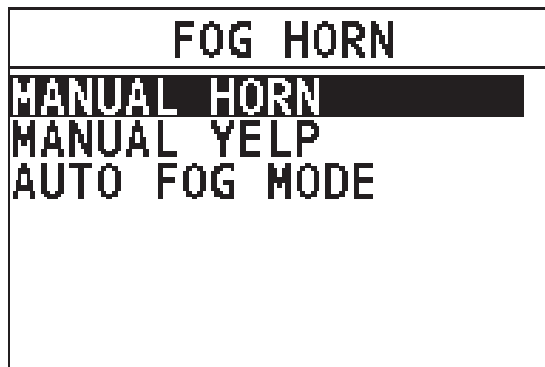

Use the manual horn

The Manual Horn feature allows you to manually start the predefined fog horn.

- Step 1 On the "FOG HORN" page, select "MANUAL HORN".

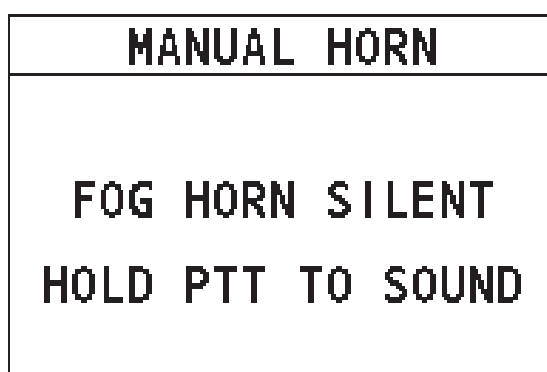

- Step 2 Press and hold the **PTT** key to sound the fog horn.
- Step 3 To stop the fog horn, release the **PTT** key.
- Step 4 Press the **Back** key to return to the previous screen.

Use the manual yelp

The Manual Yelp feature allows you to manually start the predefined alarm in emergencies.

- Step 1 On the "FOG HORN" page, select "MANUAL YELP".
- Step 2 Press and hold the **PTT** key to sound the alarm.
- Step 3 To stop the alarm, release the **PTT** key.
- Step 4 Press the **Back** key to return to the previous screen.

Use the auto horn

The Auto Horn feature allows the radio to sound certain international standard fog horn tones. When a horn sounds, it cannot be stopped manually.

- Step 1 On the "FOG HORN" page, select "AUTO FOG MODE".
- Step 2 Select a horn according to your purpose.
Then the horn sounds.

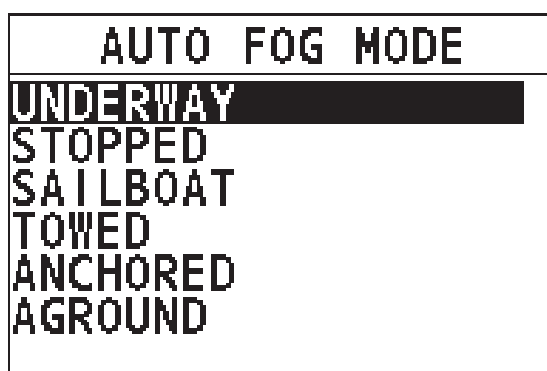

- Step 3 When the horn is silent, press the **Back** key to return to the previous screen.

Sound warning signals

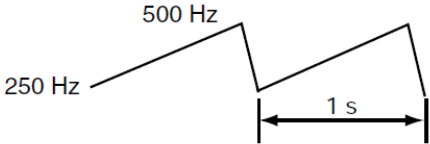
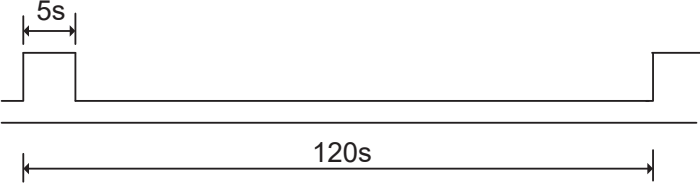
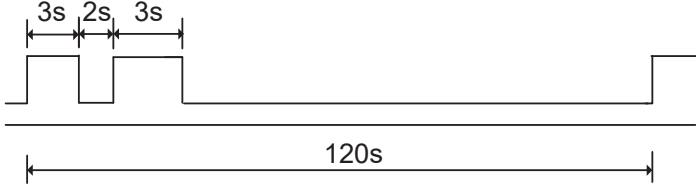
Warning Signal	Function	Remarks
Manual	For ship passing.	The lengths and timing of the horn blasts are controlled by pressing and holding the PTT key on the handset.
Yelp	For emergency siren.	 <p style="text-align: center;"><i>Yelp signal</i></p>
Underway	For power-driven vessels underway.	<p>One 5-second blast at 120-second interval.</p>  <p style="text-align: center;"><i>Underway Signal</i></p>
Stopped	For power-driven vessel that is stationary.	<p>Two 3-second blasts, with a 2-second interval between each blast, repeated every 120 seconds.</p>  <p style="text-align: center;"><i>Stopped Signal</i></p>
Sailboat	For sailboats, tug boats and tow boats underway.	<p>One 3-second blast, followed by one 2-second interval, one 1-second blast, one 2-second interval and one 1-second blast. Repeated every 120 seconds.</p>

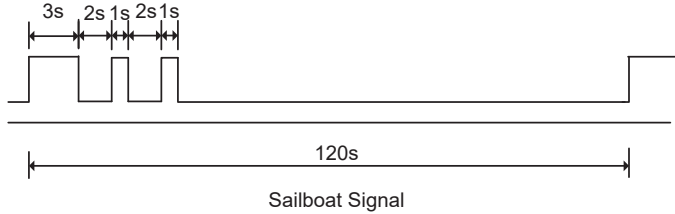
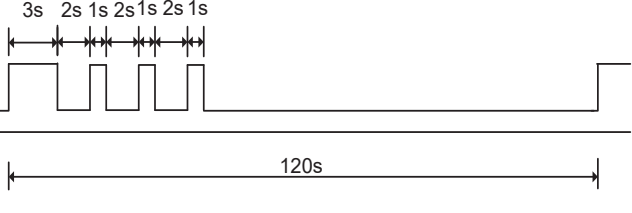
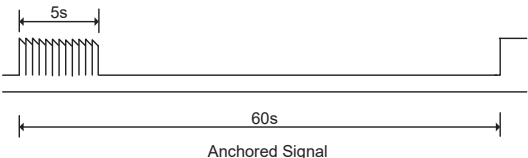
Warning Signal	Function	Remarks
		 <p style="text-align: center;">Sailboat Signal</p>
Towed	For vessels under tow.	<p>One 3-second blast, followed by one 2-second interval, one 1-second blast, one 2-second interval, one 1-second blast, one 2-second interval, and one 1-second blast. Repeated every 120 seconds.</p>  <p style="text-align: center;">Towed Signal</p>
Anchored	For vessels at anchor.	<p>A rapidly ringing bell tone sounds for about 5 seconds, repeated at an interval of 60 seconds.</p>  <p style="text-align: center;">Anchored Signal</p>
Aground	For vessels aground.	<p>Two bell tones of 0.5 seconds, a bell tone of 1.5 second followed by a rapidly ringing bell tone for a duration of about 5 seconds, followed by two bell tone of 0.5 seconds and a bell tone of 1.5seconds. Repeated once every 60seconds.</p>

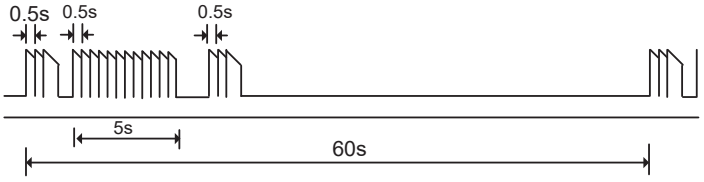
Warning Signal	Function	Remarks
		 <p style="text-align: center;">Aground Signal</p>

8.2 Hailer

The Hailer feature allows you to make an announcement at a high volume to people using a hailer and listen to the response from the hailer.

- Step 1 On the home screen, press the **Menu/DSC** control to enter the "MAIN MENU" screen.
- Step 2 Go to "FOG/HAILER/IC > HAILER".
The "HAILER" page appears on the screen.

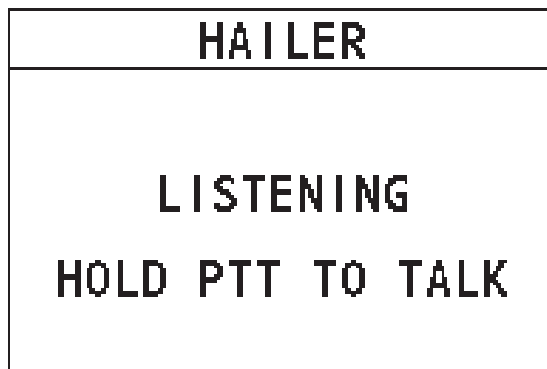

You can adjust the listening volume of each handset separately.



- Step 3 Press and hold the **PTT** key to talk.

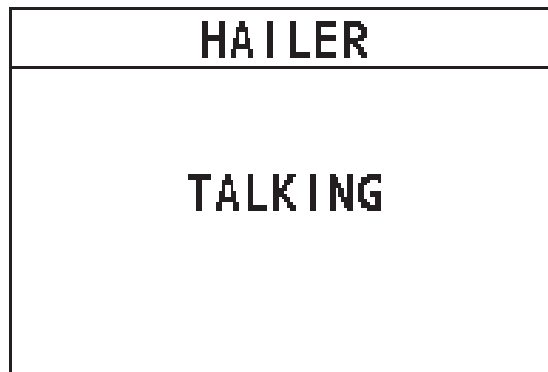

You can adjust the talking volume.

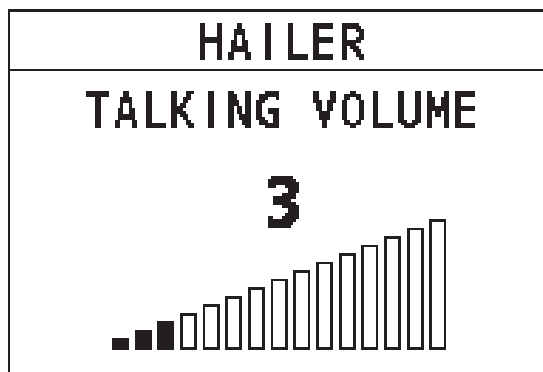

Step 4 Release the **PTT** key to listen to the response from the hailer.

Step 5 Press the **Back** key to return to the previous screen.

8.3 Intercom

The Intercom feature allows the intercommunication between the handsets. This feature is available only when your radio is equipped with more than one handset.

Step 1 On the home screen, press the **Menu/DSC** control to enter the "MAIN MENU" screen.

Step 2 Go to "FOG/HAILER/IC > INTERCOM".

The "INTERCOM" page appears on the screen. Here "River" is the alias of handset to be connected remotely.

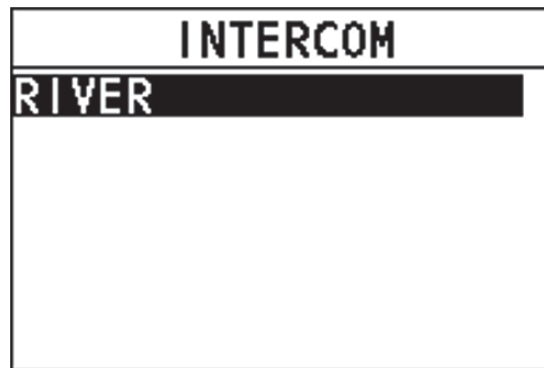

- Step 3 Select the handset to initiate a call, and cancel the call to press the **Menu/DSC** control.



- Step 4 For the called party, press and hold the **PTT** key to talk.



Screen for the intercom of the called party

- Step 5 Release the **PTT** key to listen to the response from the handset.
You can adjust the receiving volume of each handset separately after releasing the **PTT** key.
- Step 6 When the call is over, press the **Back** key to return to the previous screen.

8.4 Edit Handset Name

You can customize the handset name after the handset connects to the product remotely. After that, the handset name is saved and displayed on any connected

product.

To edit the handset name, do as follows:

Step 1 Press the **Menu/DSC** control until the "MAIN MENU" screen appears.

Step 2 Select "FOG/HAILER/IC".

The " FOG/HAILER/IC " page appears on the screen.

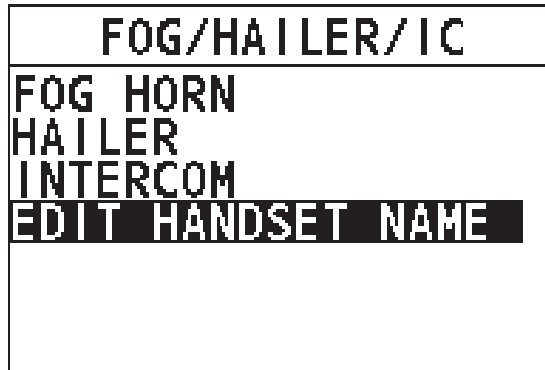

Step 3 Select "EDIT HANDSET NAME".

The "HANDSET LIST" page appears on the screen.



Step 4 Select a desired handset.

Step 5 Rotate and press the **Menu/DSC** control to enter a new handset name for the current selected handset.

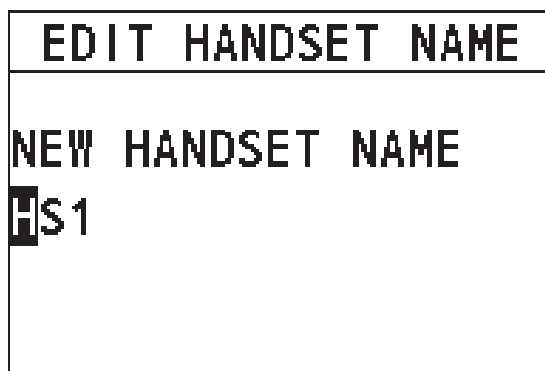

Step 6 Press the **Menu/DSC** control to save the new handset name and return to the previous screen.

9. SETTING MMSI

You can register a MMSI and view the registered MMSI.

For information about how to set MMSI number of your vessel, see section 4.2.2 How to Enter Your MMSI Number.

10. GENERAL SETUP

10.1 Display Setup

This feature allows you to set the backlight and contrast of the screen for each handset separately.

10.1.1 Adjusting the Backlight

- Step 1 On the home screen, press the **Menu/DSC** control to enter the "MAIN MENU" screen.
- Step 2 Go to "GENERAL SETUP > DISPLAY SETUP".
The "DISPLAY" page appears on the screen.

GENERAL SETUP	DISPLAY
DISPLAY SETUP	BACKLIGHT
UNITS	CONTRAST
KEY BEEP	
GNSS SETUP	
I/O PORT SETUP	
SYSTEM INFO	
FOG HORN FREQ	

- Step 3 Select "BACKLIGHT".
- Step 4 Rotate the **Menu/DSC** control to adjust the backlight.

10.1.2 Adjusting the Contrast

- Step 1 On the home screen, press the **Menu/DSC** control to enter the "MAIN MENU" screen.
- Step 2 Go to "GENERAL SETUP > DISPLAY SETUP".
The "DISPLAY" page appears on the screen.
- Step 3 Select "CONTRAST".
- Step 4 Rotate the **Menu/DSC** control to adjust the contrast.

10.2 Units

10.2.1 Time Format

This feature allows you to set how the time displays on the radio screen.

- Step 1 Press the **Menu/DSC** control until the "MAIN MENU" screen appears.

Step 2 Go to "GENERAL SETUP > UNITS > TIME FORMAT".

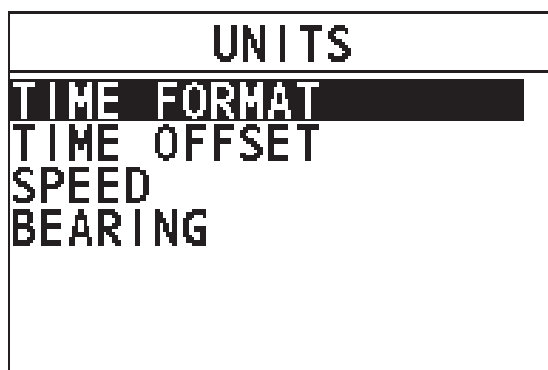

Step 3 Select "12 HOUR" or "24 HOUR".

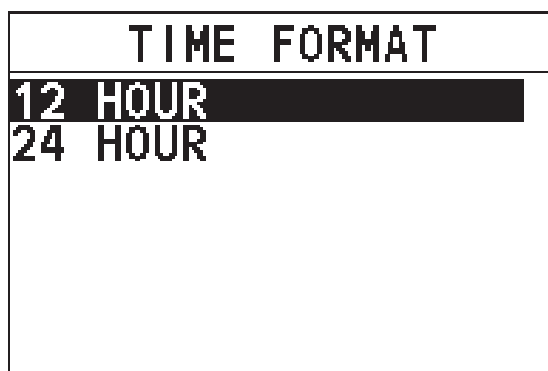

Step 4 Press the **Menu/DSC** control to save the setting and return to the previous page.

10.2.2 Time Offset

This feature allows you to set the time difference between UTC and local time if you want to use local time. The offset is added to or subtracted from the time received from the GNSS receiver or chart plotter.

Step 1 Press the **Menu/DSC** control until the "MAIN MENU" screen appears.

Step 2 Go to "GENERAL SETUP > UNITS > TIME OFFSET".

Step 3 Select the time offset of your location.



- Step 4 Press the **Menu/DSC** control to save the setting and return to the previous page.

10.2.3 Speed

This feature allows you to set the unit of measurement for sailing speed.

Note

A GNSS receiver should be connected to the radio or the "INTERNAL GNSS" should be set to "ON" to show the sailing speed.

- Step 1 Press the **Menu/DSC** control until the "MAIN MENU" screen appears.
- Step 2 Go to "GENERAL SETUP > UNITS > SPEED".
- Step 3 Select a unit.
- Step 4 Press the **Menu/DSC** control to save the setting and return to the previous page.

10.2.4 Bearing

This feature allows you to set the mode (magnetic or true).

Note

A GNSS receiver should be connected to the radio or the "INTERNAL GNSS" should be set to "ON" to show the bearing.

- Step 1 Press the **Menu/DSC** control until the "MAIN MENU" screen appears.
- Step 2 Go to "GENERAL SETUP > UNITS > BEARING".
- Step 3 Select "TRUE" or "MAGNETIC".
- Step 4 Press the **Menu/DSC** control to save the setting and return to the previous page.

10.3 Key Beep

This feature allows you to set the volume level of the beep that is emitted when a key is pressed. The keep beep volume of each handset is adjusted separately.

- Step 1 Press the **Menu/DSC** control until the "MAIN MENU" screen appears.
- Step 2 Go to "GENERAL SETUP > KEY BEEP".
- The following page appears on the screen.

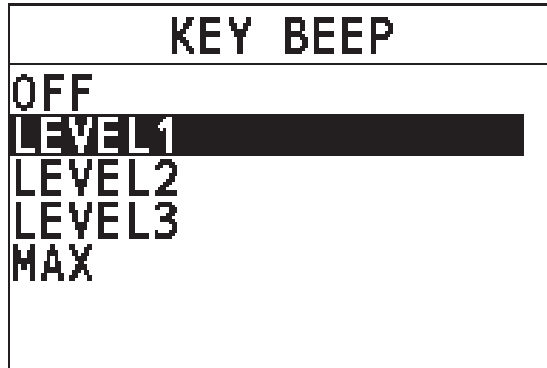

- Step 3 Select a level.
- Step 4 Press the **Menu/DSC** control to save the setting and return to the previous page.

10.4 GNSS Setup

This section allows you to set how to show the time and the position information of the vessel.

10.4.1 Entering the "GNSS SETUP" Page

- Step 1 Press the **Menu/DSC** control until the "MAIN MENU" screen appears.
- Step 2 Go to "GENERAL SETUP > GNSS SETUP".
- The following page appears on the screen.

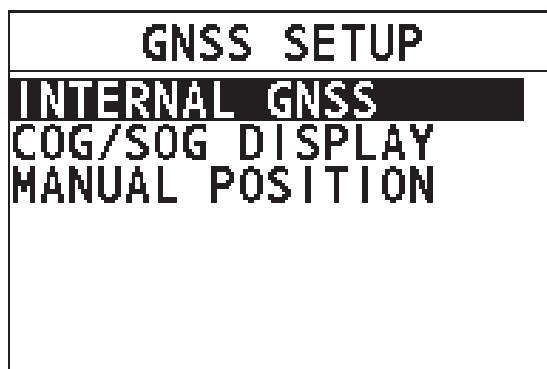

10.4.2 Internal GNSS

This feature allows you to set whether to show the position and time information obtained through the internal GNSS.

- Step 1 In the "GNSS SETUP" page, select "INTERNAL GNSS".

The following page appears on the screen.

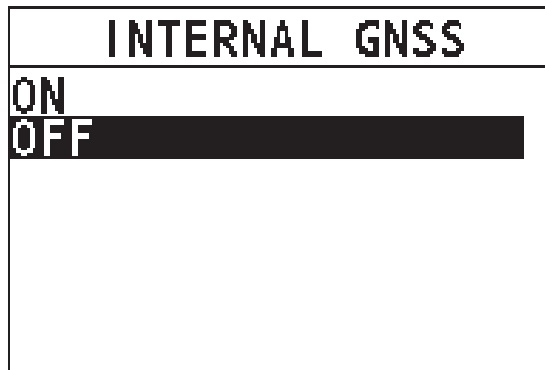

Step 2 Select "ON" or "OFF".

Step 3 Press the **Menu/DSC** control to save the setting and return to the previous page.

10.4.3 COG/SOG Display

This feature allows you to set whether to show Course Over Ground (COG)/Speed Over Ground (SOG) on the radio screen.

Step 1 In the "GNSS SETUP" page, select "COG/SOG DISPLAY".

The following page appears on the screen.

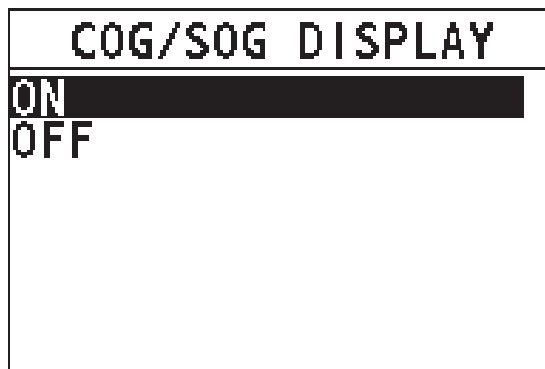

Step 2 Select "ON" or "OFF".

Step 3 Press the **Menu/DSC** control to save the setting and return to the previous page.

10.4.4 Manual Position

This feature allows you to input the time and the longitude and the latitude of the vessel.

Step 1 In the "GNSS SETUP" page, select "MANUAL POSITION" page

Step 2 Rotate and press the **Menu/DSC** control to input your position.

- Step 3 After you input all information, press the **Menu/DSC** control to save the setting and return to the previous page.

10.5 I/O Port Setup

This section allows you to set whether to output GNSS, DSC and AIS data and allows you to select the port for outputting these data.

There are two baud rates available for NMEA0183. When "AIS OUTPUT" is set to "ON", the baud rate is 38400. When "AIS OUTPUT" is set to "OFF", the baud rate is 4800.

10.5.1 Entering the "I/O PORT SETUP" Page

- Step 1 Press the **Menu/DSC** control until the "MAIN MENU" screen appears.
- Step 2 Go to "GENERAL SETUP > I/O PORT SETUP".
- The following page appears on the screen.

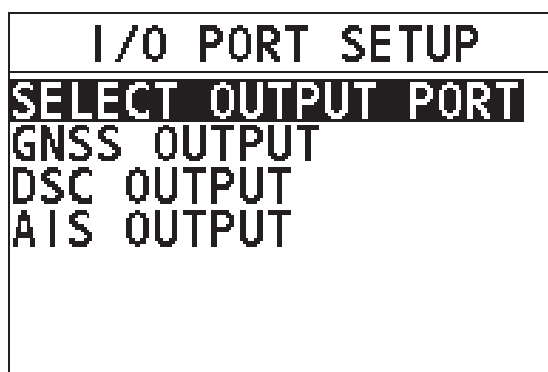

10.5.2 Selecting Output Port

This feature allows you to select the port for outputting GNSS, DSC and AIS data.

- Step 1 In the "I/O PORT SETUP" page, select "SELECT OUTPUT PORT".
- The following page appears on the screen.

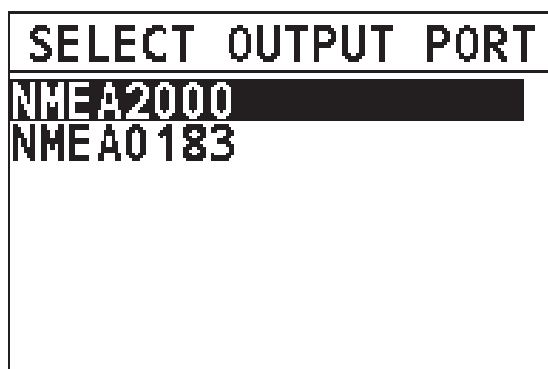

- Step 2 Select "NMEA2000" or "NMEA0183".

- Step 3 Press the **Menu/DSC** control to save the setting and return to the previous page.

10.5.3 GNSS OUTPUT

This feature allows you to set whether to output the GNSS data.

- Step 1 In the "I/O PORT SETUP" page, select "GNSS OUTPUT".
The following page appears on the screen.

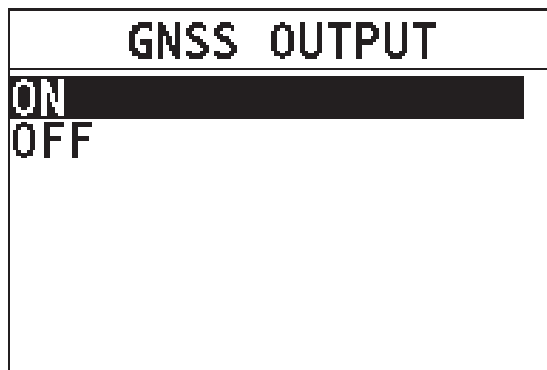

- Step 2 Select "ON" or "OFF".
- Step 3 Press the **Menu/DSC** control to save the setting and return to the previous page.

10.5.4 DSC OUTPUT

This feature allows you to set whether to output the DSC data.

- Step 1 In the "I/O PORT SETUP" page, select "DSC OUTPUT".
The following page appears on the screen.

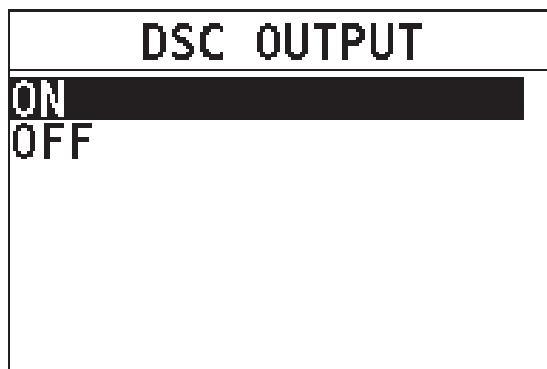

- Step 2 Select "ON" or "OFF".
- Step 3 Press the **Menu/DSC** control to save the setting and return to the previous page.

10.5.5 AIS OUTPUT

This feature allows you to set whether to output the AIS data.

- Step 1 In the "I/O PORT SETUP" page, select "AIS OUTPUT".
The following page appears on the screen.

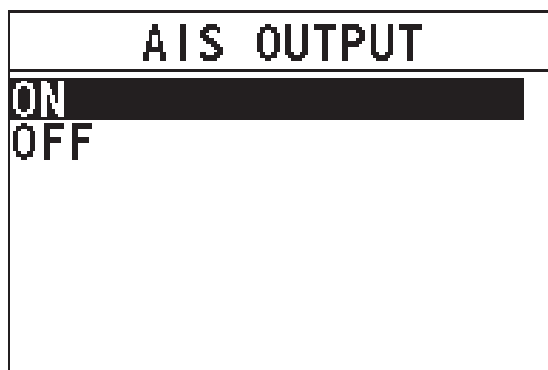

- Step 2 Select "ON" or "OFF".
Step 3 Press the **Menu/DSC** control to save the setting and return to the previous page.

10.6 System Information

10.6.1 Entering the "SYSTEM INFO" Page

- Step 1 Press the **Menu/DSC** control until the "MAIN MENU" screen appears.
Step 2 Go to "GENERAL SETUP > SYSTEM INFO".
The following page appears on the screen.

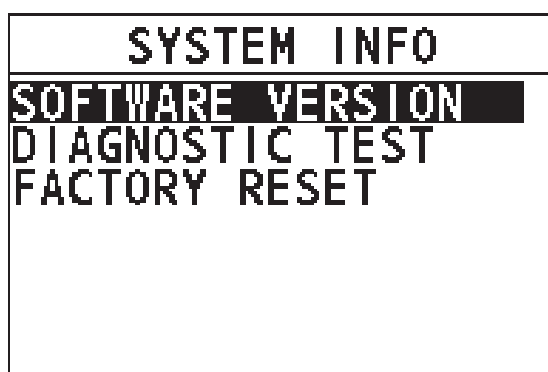

10.6.2 Software Version

This feature allows you to view software versions of the radio and connected units.

- Step 1 In the "SYSTEM INFO" page, select "SOFTWARE VERSION".
The "SOFTWARE VERSION" page appears on the screen.

- Step 2 Select "OWN UNIT" to view the version of the radio, or select "ALL UNIT" to view to view the versions of the radio and connected units.
- Step 3 After you view the information, press the **Menu/DSC** control to return to the previous screen.

10.6.3 Diagnostic Test

This feature allows you to test items as shown in the following table. You can also see explanations of testing results in the following table.

Testing Item	Explanation of Testing Result
GNSS	OK: There is a GNSS data source. NG: There is no GNSS data source.
DSC	OK: The DSC feature works normally. NG: The DSC feature doesn't work.
BATTERY	OK: The operating voltage is between 10.8 V DC and 15.6 V DC. LOW: The operating voltage is lower than 10.8 V DC. HIGH: The operating voltage is higher than 15.6 V DC.
AIS	OK: The AIS feature works normally. NG: The AIS feature doesn't work.
MEMORY	OK: The internal memory is normal. NG: The internal memory is abnormal.
REMOTE STATION	OK: Handset is connected to the radio. NG: No handset is connected to the radio.

- Step 1 In the "SYSTEM INFO" page, select "DIAGNOSTIC TEST".
The "SYSTEM TEST" page appears on the screen.
- Step 2 Select the item requiring testing.
- Step 3 Press the **Menu/DSC** control to start testing.
- Step 4 When the test is over, press the **Back** key to return to the previous screen.

10.6.4 Factory Reset

This feature resets several menus and settings to their default values. For details on which menu / settings are reset, see the underlined items in the menu tree.

- Step 1 In the "FACTORY RESET" page, select "FACTORY RESET". The "FACTORY RESET" page appears on the screen.

- Step 2 Select whether to reset the items to factory settings. If you select "YES", the radio will restart and is reset to factory settings. If you select "NO", the radio returns to the previous screen.

10.7 Fog Horn Frequency

This feature allows you to set the fog horn frequency according to the size of your vessel.



The default fog horn frequency is 400Hz. In most cases, do not change the frequency unless the vessel is very large.

- Step 1 Press the **Menu/DSC** control until the "MAIN MENU" screen appears.
- Step 2 Go to "GENERAL SETUP > FOG HORN FREQ".
- Step 3 Select a "FOG HORN FREQ".
- Step 4 Press the **Menu/DSC** control to save the setting and return to the previous screen.

10.8 Service Menu

This menu is available only for your dealer.

11. CHANNEL FUNCTION SETUP

11.1 Channel Group

This feature allows you to select a channel group among International, USA, and Canada channel groups.

Step 1 Press the **Menu/DSC** control until the "MAIN MENU" screen appears.

Step 2 Go to "CH FUNCTION SETUP > CH GROUP".

The following page appears on the screen.



Step 3 Select "INTERNATIONAL", "USA", or "CANADA".

Step 4 Press the **Menu/DSC** control to save the setting.

11.2 Second Priority Channel

This feature allows you to set the second priority channel which to be scanned in the TRIPLE CH mode.

Step 1 Press the **Menu/DSC** control until the "MAIN MENU" screen appears.

Step 2 Go to "CH FUNCTION SETUP > 2ND PRIORITY".

The following page appears on the screen.

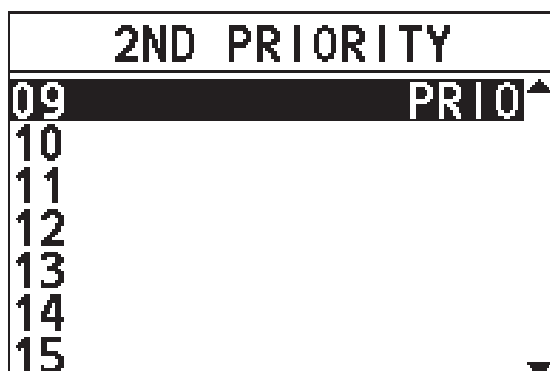

- Step 3 Select a channel.
- Step 4 Press the **Menu/DSC** control to set the channel to the second priority channel and then return to the previous screen.

11.3 Edit Channel Name

When the radio mode is in use, the display shows a name under the channel number selected. This is the name of the current channel. You can customize channel names as follows:

- Step 1 Press the **Menu/DSC** control until the "MAIN MENU" screen appears.
- Step 2 Select "CH FUNCTION SETUP".
- The "CH FUNCTION SETUP" page appears on the screen.

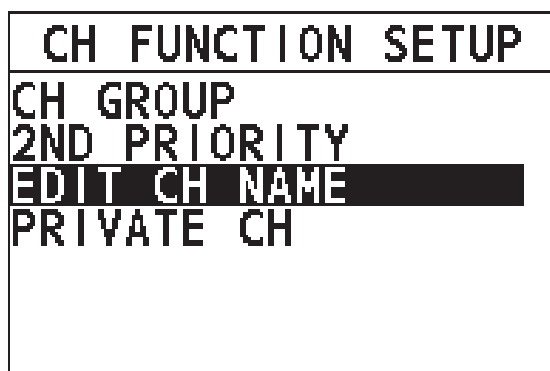

- Step 3 Select "EDIT CH NAME".
- Step 4 Rotate and press the **Menu/DSC** control to enter a new channel name for the current working channel.

EDIT CH NAME
ENTER THE NEW NAME
SHIP-SHIP
CUR CHANNEL NO:06

- Step 5 Press the **Menu/DSC** control to save the new channel name and return to the previous screen.

11.4 Private Channel

This feature allows you to select a private channel.

Note

The "PRIVATE CH" menu is available only when the channel group is set to "INTERNATIONAL". For information about how to set the channel group, see section 11.1 Channel Group.

- Step 1 Press the **Menu/DSC** control until the "MAIN MENU" screen appears.
- Step 2 Go to "CH FUNCTION SETUP > PRIVATE CH".
- The following page appears on the screen.

PRIVATE CH
BELGIUM EN ▲
DK LEISURE
DK FISH
FI LEISURE
FI FISH
HOLLAND
NOR LEISURE ▼

- Step 3 Select a private channel.
- Step 4 Press the **Menu/DSC** control to save the setting and return to the previous screen.

12. DSC SETUP

12.1 Individual Directory

This feature allows you to save vessels' names or persons' names and the MMSI numbers associated with vessels you want to transmit individual calls, position request calls, and DSC test calls.

12.1.1 Adding an Entry

You can add 200 entries at most.

Step 1 Press the **Menu/DSC** control until the "MAIN MENU" screen appears.

Step 2 Go to "DSC SETUP > INDIV DIRECTORY".

The following page appears on the screen.



Step 3 Select "ADD ENTRY".

Step 4 Rotate and press the **Menu/DSC** control to add the name and the MMSI of the contact.

Step 5 After you finish entering the information, press the **Menu/DSC** control to save the setting and return to the previous screen.

ADD ENTRY
NAME : CC C MMSI : 112210000
PRESS MENU/DSC KNOB

12.1.2 Editing an Entry

- Step 1 Press the **Menu/DSC** control until the "MAIN MENU" screen appears.
- Step 2 Go to "DSC SETUP > INDIV DIRECTORY".
- Step 3 Select the entry needing editing.
The following page appears on the screen.

INDIV DIRECTORY
NAME : A0 MMSI : 100000000
EDIT DELETE OK

- Step 4 Select "EDIT".
- Step 5 Rotate and press the **Menu/DSC** control to edit the entry.

EDIT ENTRY
NAME : A 0----- MMSI : 100000000

- Step 6 After you finish entering the information, press the **Menu/DSC** control to save the setting and return to the previous screen.

12.1.3 Deleting an Entry

- Step 1 Press the **Menu/DSC** control until the "MAIN MENU" screen appears.
- Step 2 Go to "DSC SETUP > INDIV DIRECTORY".
- Step 3 Select the entry needing deleting.
- Step 4 Select "DELETE".
- Step 5 Select "YES".
The directory is deleted and the radio returns to the previous screen.

12.2 Group Directory

This feature allows you to add, edit or delete groups the radio belongs to.

12.2.1 Adding an Entry

- Step 1 Press the **Menu/DSC** control until the "MAIN MENU" screen appears.
- Step 2 Go to "DSC SETUP > GROUP DIRECTORY".
The following page appears on the screen.

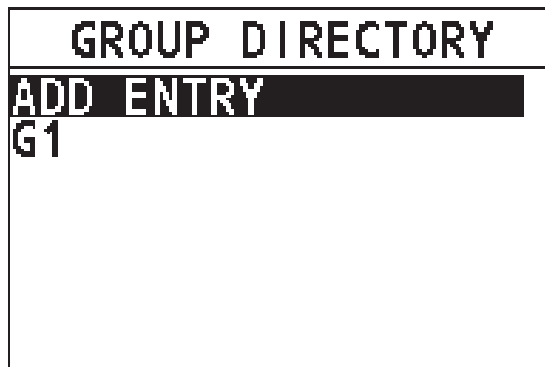

- Step 3 Select "ADD ENTRY".
- Step 4 Rotate and press the **Menu/DSC** control to add the name and the MMSI of the contact.
- Step 5 After you finish entering the information, press the **Menu/DSC** control to save the setting and return to the previous screen.

ADD ENTRY
NAME : G3 MMSI : 030000000
PRESS MENU/DSC KNOB

12.2.2 Editing an Entry

- Step 1 Press the **Menu/DSC** control until the "MAIN MENU" screen appears.
- Step 2 Go to "DSC SETUP > GROUP DIRECTORY".
- Step 3 Select the entry needing editing.
The following page appears on the screen.

GROUP DIRECTORY
NAME : G2 MMSI : 020000000
EDIT DELETE OK

- Step 4 Select "EDIT".
- Step 5 Rotate and press the **Menu/DSC** control to edit the entry.
- Step 6 After you finish entering the information, press the **Menu/DSC** control to save the setting and return to the previous screen.

12.2.3 Deleting an Entry

- Step 1 Press the **Menu/DSC** control until the "MAIN MENU" screen appears.
- Step 2 Go to "DSC SETUP > GROUP DIRECTORY".
- Step 3 Select the entry needing deleting.
- Step 4 Select "DELETE".
- Step 5 Select "YES".
The directory is deleted and the radio returns to the previous screen.

12.3 Channel Change Mode

This feature allows you to set the channel change mode of the radio. When selecting "MANUAL", you need to manually change the channel. When you select "AUTO", the radio automatically switches to the designated channel after 10 seconds without user intervention.

Step 1 Press the **Menu/DSC** control until the "MAIN MENU" screen appears.

Step 2 Go to "DSC SETUP > AUTO CHANGE CH".

The following page appears on the screen.

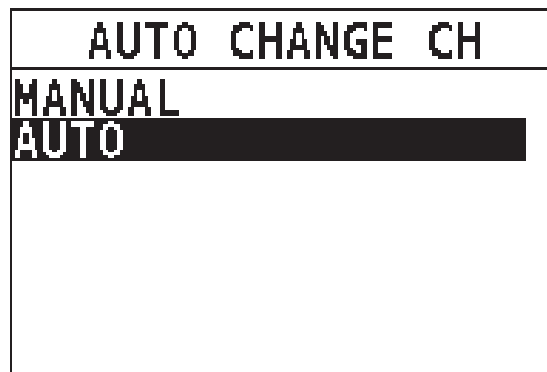

Step 3 Select "MANUAL" or "AUTO".

Step 4 Press the **Menu/DSC** control to save the setting and return to the previous screen.

12.4 Individual Acknowledgement

This feature allows you to set the acknowledgement mode of individual call requests.

Step 1 Press the **Menu/DSC** control until the "MAIN MENU" screen appears.

Step 2 Go to "DSC SETUP > INDIVIDUAL ACK".

The "INDIVIDUAL ACK" page appears on the screen.

Step 3 Select "MANUAL" or "AUTO".

- **MANUAL:** Select the soft key, and then you need to send an acknowledgement manually upon a call request.
- **AUTO:** Select the soft key, and then the radio sends an unacknowledged message upon a call request.

Step 4 Press the **Menu/DSC** control to save the setting and return to the previous screen.

12.5 Position Acknowledgement

This feature allows you to set the acknowledgement mode of position request calls.

- Step 1 Press the **Menu/DSC** control until the "MAIN MENU" screen appears.
- Step 2 Go to "DSC SETUP > POSITION ACK".
The "POSITION ACK" page appears on the screen.
- Step 3 Select "MANUAL", "AUTO", or "IGNORE".
- **MANUAL:** Select the soft key, and then you need to send an acknowledgement manually upon a call request.
 - **AUTO:** Select the soft key, and then the radio sends an acknowledgement automatically upon a call request.
 - **IGNORE:** Select the soft key, and then the radio ignores the call request without sending an acknowledgement.
- Step 4 Press the **Menu/DSC** control to save the setting and return to the previous screen.

12.6 Test Acknowledgement

This feature allows you to set the acknowledgement mode of DSC test call requests.

- Step 1 Press the **Menu/DSC** control until the "MAIN MENU" screen appears.
- Step 2 Go to "DSC SETUP > TEST ACK".
The "TEST ACK" page appears on the screen.
- Step 3 Select "MANUAL" or "AUTO".
- **MANUAL:** Select the soft key, and then you need to send an acknowledgement manually upon a call request.
 - **AUTO:** Select the soft key, and then the radio sends an acknowledgement automatically upon a call request.
- Step 4 Press the **Menu/DSC** control to save the setting and return to the previous screen.

12.7 Auto Position Interval

This feature allows you to set the interval of sending auto position polling to another vessel.

- Step 1 Press the **Menu/DSC** control until the "MAIN MENU" screen appears.
- Step 2 Go to "DSC SETUP > AUTO POS INTERVAL".
The "AUTO POS INTERVAL" page appears on the screen.
- Step 3 Select a time interval.
- Step 4 Press the **Menu/DSC** control to save the setting and return to the previous screen.

12.8 Timeout

This feature allows you to set the number of minutes the radio should keep a given screen displayed before it restores the standby display, if no radio operation is detected.

You can set a timeout for two types of screen: the non-distress screen and the distress transmitting screen.

Step 1 Press the **Menu/DSC** control until the "MAIN MENU" screen appears.

Step 2 Go to "DSC SETUP > TIMEOUT".

The "TIMEOUT" page appears on the screen.



Step 3 Select "NON DISTRESS" or "RX DISTRESS".

Step 4 Do one of the following:

- To enable the Timeout feature, select "15 MIN ".
The message selected at step 4 is closed automatically when there is no operation within 15 minutes.
- To disable the Timeout feature, select "NO TIMEOUT".

Step 5 Press the **Menu/DSC** control to save the setting and return to the previous screen.

12.9 Alarm

This feature allows you to set the behavior of alarm when the radio receive DSC safety and routine calls.

Step 1 Press the **Menu/DSC** control until the "MAIN MENU" screen appears.

Step 2 Go to "DSC SETUP >ALARM".

The "ALARM" page appears on the screen.

ALARM	SAFETY
SAFETY ROUTINE	ON OFF

- Step 3 Select "SAFETY" or "ROUTINE".
- Step 4 Do one of the following:
- To enable the alarm, select "ON".
 - To disable the alarm, select "OFF".
- Step 5 Press the **Menu/DSC** control to save the setting and return to the previous screen.

13. ATIS SETUP

The FM-4850 supports the Automatic Transmitter Identification System (ATIS) used in Inland waterways in Europe. In the ATIS mode, the radio transmits a unique ATIS code each time the **PTT** key is released at the end of a transmission. You should check with your local marine regulatory authority in your country for assistance in obtaining an ATIS code.

13.1 How to Enter the ATIS ID

You can register an ATIS ID, and also view the registered ID, as follows:

Caution

An ATIS ID can be entered only once. Therefore, be careful not to enter the wrong ATIS ID. If you need to change the ID after it has been entered, contact your dealer.

Step 1 Press the **Menu/DSC** control until the "MAIN MENU" screen appears.

Step 2 Go to "ATIS SETUP > SET ATIS ID".

The following page appears.

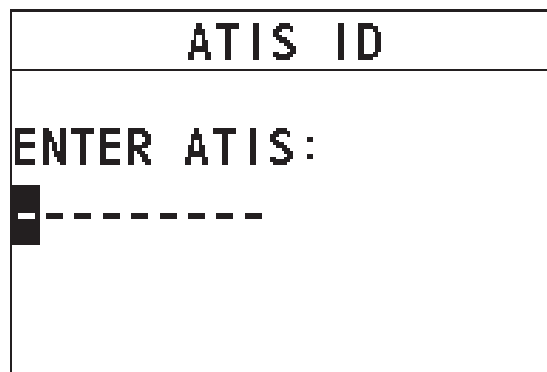

Step 3 Rotate and press the **MENU/DSC** control to enter your ATIS ID (nine digits).

If you enter a wrong digit, press the **BACK** key until the wrong digit is selected, and then enter a correct digit.

Step 4 After you enter the ATIS ID, press the **Menu/DSC** control to save it.

Step 5 Enter the ATIS ID again, and then press the **Menu/DSC** control to save it.

If you enter a different digit that you entered at Step 3 and press the Menu/DSC control, automatically return to the Step 3.

13.2 How to Enable/Disable the ATIS Feature

Step 1 Press the **Menu/DSC** control until the "MAIN MENU" screen appears.

Step 2 Select "ATIS SETUP".

The "ATIS SETUP" page appears on the screen.

Step 3 Do one of the following:

- To enable the ATIS feature, select "ON". If you haven't entered the ATIS ID, you are required to enter the ID first.
- To disable the ATIS feature, select "OFF".

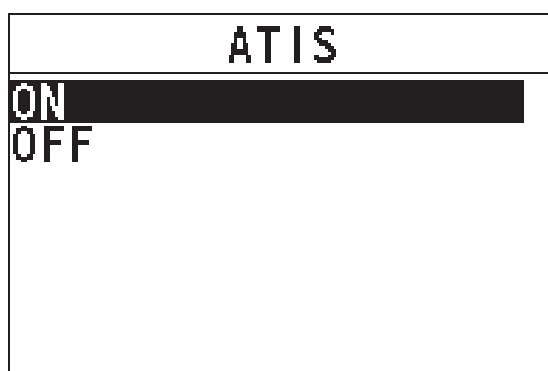

14. MAINTENANCE AND TROUBLESHOOTING



Warning

Do not open the equipment. This equipment uses high voltage that can cause electrical shock.



Note

Do not apply paint, anti-corrosive sealant, or contact spray to plastic parts or equipment coating. Those items contain products that can damage plastic parts and equipment coating.

14.1 General Maintenance



Caution

The heat sink can get hot enough to cause a burn injury. Allow the unit to cool before doing any maintenance procedures.



The inherent quality of the solid-state components used in this radio should provide many years of continuous use. However, take the following precautions to prevent damage to the radio.

- Keep the handsets connected or the jack covered at all times to prevent corrosion of electrical contacts.
- Remove dust from the cabinet with a dry clean cloth. Do not use commercial cleaners to clean the equipment. Those cleaners can remove paint and markers.
- Check that all cables are tightly fastened. Check the cables for corrosion and rust. Connect the cables that have loosened. Replace any damaged cables.
- Never press and hold the **PTT** key and talk into the handset to transmit your voice unless an antenna or suitable dummy load is connected to the radio.
- The supply voltage range to the radio must be within 10.8 to 15.6 VDC.
- Use only FURUNO-approved accessories and replacement parts.
- In the unlikely event of serious problems, please contact your dealer.

14.2 Troubleshooting

When the FM-4850 does not work properly, you can follow the following troubleshooting procedures to fix it.

Problem	Possible Cause	Solution
The radio cannot be turned on.	No DC voltage to the radio, or blown fuse	<p>Step 1 Check the 10.8 to 15.6 VDC battery connections and the fuse.</p> <p>Step 2 Long press the On/Off key to turn on the handset.</p>
The radio blows the fuse when connected to the power supply.	Reversed polarity of power wires	<p>Step 1 Make sure the red wire is connected to the positive (+) battery post, and the black wire is connected to the negative (-) battery post.</p> <p>Step 2 Check the power cable for DC voltage and replace the fuse (8A 250V).</p>
The speaker makes popping or whining noise while the engine of the ship runs.	Engine noise	<p>Step 1 Reroute the DC power cable of the radio away from the engine.</p> <p>Step 2 Add a noise suppressor on the power cable.</p> <p>Step 3 Change to resistive spark plug wires and/or add an alternator whine filter.</p>
The sound is not emitted from the speaker of the handset.	Accessory cable	<p>Step 1 Check that the handset is physically connected.</p> <p>Step 2 Check whether the handset is broken or short-circuited.</p>
The sound is not emitted from the speaker.	Accessory cable	<p>Step 1 Check that the cable (Red & Black) is physically connected.</p>

Problem	Possible Cause	Solution
		Step 2 Check whether the speaker cable is broken or short-circuited.
Transmissions are always on low power even when high power is selected.	Antenna	Check the antenna or test the radio with another antenna.
The icon  or  appears on the home screen.	Too high or too low power supply voltage	Confirm that the connected power supply voltage is within 10.8 to 15.6 VDC.
Your position is not displayed.	Accessory cable	Check the NMEA2000 or NMEA0183 cable connection.
	Setting of the GNSS receiver	Choose the proper information to check: <ul style="list-style-type: none"> ● If the NMEA2000 or NMEA0183 cable is connected, make sure that the output of the cable is valid. ● If the NMEA2000 or NMEA0183 cable is not connected, make sure that the internal GNSS module is enabled and nothing blocks the top of the radio unit.
The radio unit displays "PLL UNLOCK".	The phase lock loop not working	Restart the radio. If the problem is not fixed, please contact your dealer.
Output power reduced to low	Power is automatically reduced to protect against overheating due to continuous transmission.	Wait until the unit cools.

Problem	Possible Cause	Solution
The radio unit displays "STARTUP FAILED. TURN THE SYSTEM OFF AND WAIT A SHORT WHILE BEFORE TURNING THE SYSTEM ON AGAIN."	Startup failed.	Turn the system off and wait a short while before turning the system on again.
Diagnostic Test result for AIS shows "NG".		
Can't receive AIS messages		

If the above solutions cannot fix your problems, or you may have some other queries, please contact us or your local dealer for more technical support.

15. INSTALLATION

15.1 Equipment Lists

Standard supply

Name	Type	Qty	Remarks
Radiotelephone	FM-4850	1	[Installation Materials] Tapping screw, UHF connector [Other] Manual, Packing list Spare Fuse (250VAC, 8A) 2pcs
Speaker	SP-4800	1	[Installation Materials] Cushion, Template, Tapping screw [Accessories] Hanger, Hanger knob
Handset	HS-4800-A	1	[Installation Materials] Tapping screw [Accessories] Hanger, Through wall kits, Extension Cable(5M)

Optional supply

Name	Type	Code no.	Remarks
Handset	HS-4800-A	001-523-260	Handset, Hanger, Installation Materials, Accessories
Speaker	SP-4800	001-468-580	Speaker, Installation Materials, Accessories
Extension Cable	EX-CBL-FM5M	001-468-600	5m
Extension Cable	EX-CBL-FM10M	001-468-610	10m
Cable for NMEA2000	FRU-NMEA-PMMFF- 010	001-506-820	w/connectors (light), 1m

Name	Type	Code no.	Remarks
	FRU-NMEA-PMMFF-020	001-506-830	w/connectors (light), 2m
	FRU-NMEA-PMMFF-060	001-507-000	w/connectors (light), 6m
	FRU-NMEA-PFF-010	001-507-010	w/connector (light), 1m
	FRU-NMEA-PFF-020	001-507-030	w/connector (light), 2m
	FRU-NMEA-PFF-060	001-507-040	w/connector (light), 6m
	CB-05PM+05BF-010	000-167-968-11	w/connectors (heavy), 1m
	CB-05PM+05BF-020	000-167-969-11	w/connectors (heavy), 2m
	CB-05PM+05BF-060	000-167-970-11	w/connectors (heavy), 6m
	CB-05BFFM-010	000-167-971-11	w/connector (heavy), 1m
	CB-05BFFM-020	000-167-972-11	w/connector (heavy), 2m
	CB-05BFFM-060	000-167-973-11	w/connector (heavy), 6m
Connector for NMEA2000	FRU-MM1MF1MF1001	001-507-050	T-Connector, Micro style:3
	NC-050505-FMF-TS001	000-160-507-10	Mini style:2, micro style:1
	FRU-MM1000000001	001-507-070	Micro style, male, termination resistor
	LTWMN-05AMMT-SL8001	000-160-508-10	Mini style, male, termination resistor
	FRU-MF000000001	001-507-060	Micro style, female, termination resistor
	LTWMN-05AFFT-SL8001	000-160-509-10	Mini style, female, termination resistor
	FRU-0505-FF-IS	001-077-830-10	w/in-line terminator

Name	Type	Code no.	Remarks
Antenna Unit	GPA-017	000-021-071	
	GPA-017S	000-029-318	
Installation Materials	CP24-00502	005-955-560	For GPA-017S
Cable Assembly	TNC-PS/ PS-3D-L15M-R	001-173-110-10	For GPA-017S, 15m cable
Right Angle Mounting Base	No.13-QA330	001-111-910-10	For GPA-017/S
L-angle Mounting Base	No.13-QA310	001-111-900-10	For GPA-017/S
Handrail Mounting Base	No.13-RC5160	001-111-920-10	For GPA-017/S
Mast Mounting Kit	CP20-01111	004-365-780	For GPA-017/S

15.2 Mounting

15.2.1 How to Install the Radio

For desktop mounting

- Step 1 Put the FM-4850 radio in a location where it is easy to install it.
- Step 2 Fix the radio with four screws.

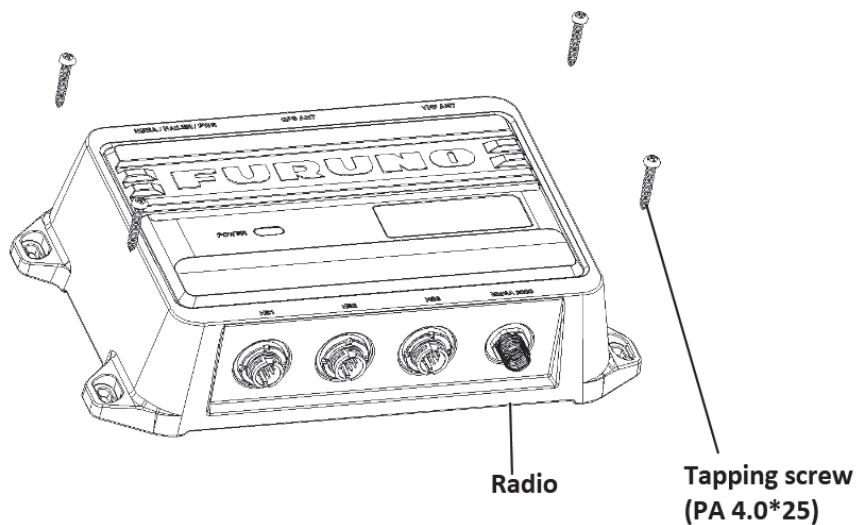

For wall mounting

- Step 1 Put the FM-4850 radio in a location where it is easy to install it.
- Step 2 Fix the radio with four screws, taking care that the radio is correctly oriented, with the cables and connectors facing upwards.

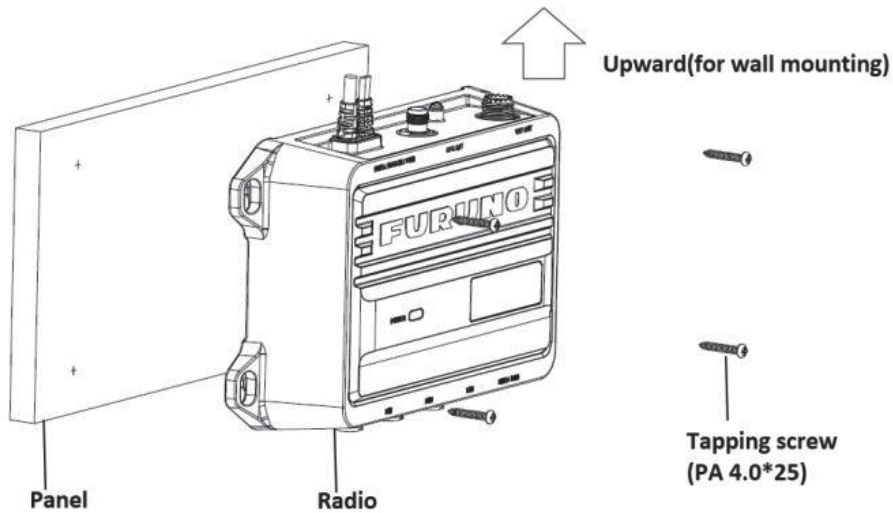

15.2.2 How to Install the Handset

- Step 1 Determine a location where it is easy to install the handset hanger.
- Step 2 Fix the hanger with three screws.
- Step 3 Place the handset into the hanger.

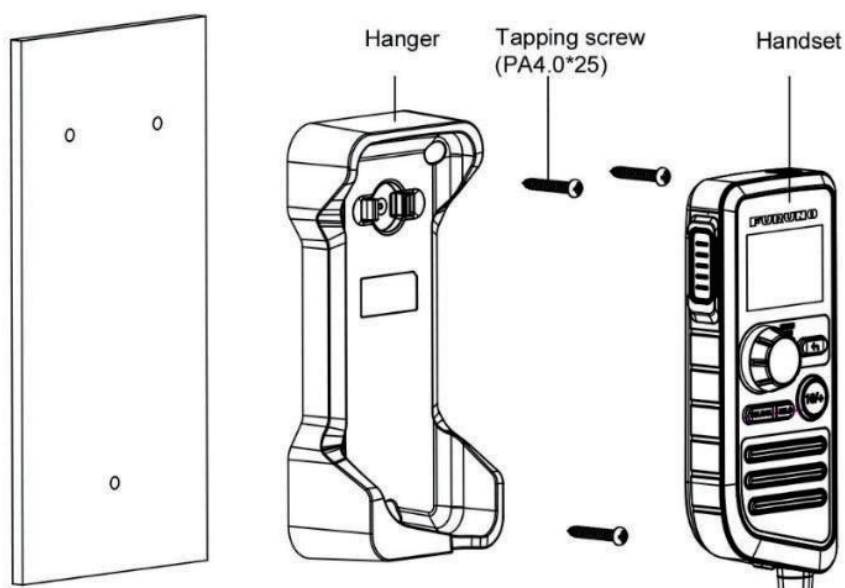

15.2.3 How to Install the Speaker

For desktop mounting

- Step 1 Put the hanger in a location where it is easy to install the SP-4800.
- Step 2 Fix the hanger with four screws.
- Step 3 Set the speaker to the bracket.
- Step 4 Tighten the knob bolts on both sides of the hanger.
- Step 5 Connect the signal cable.

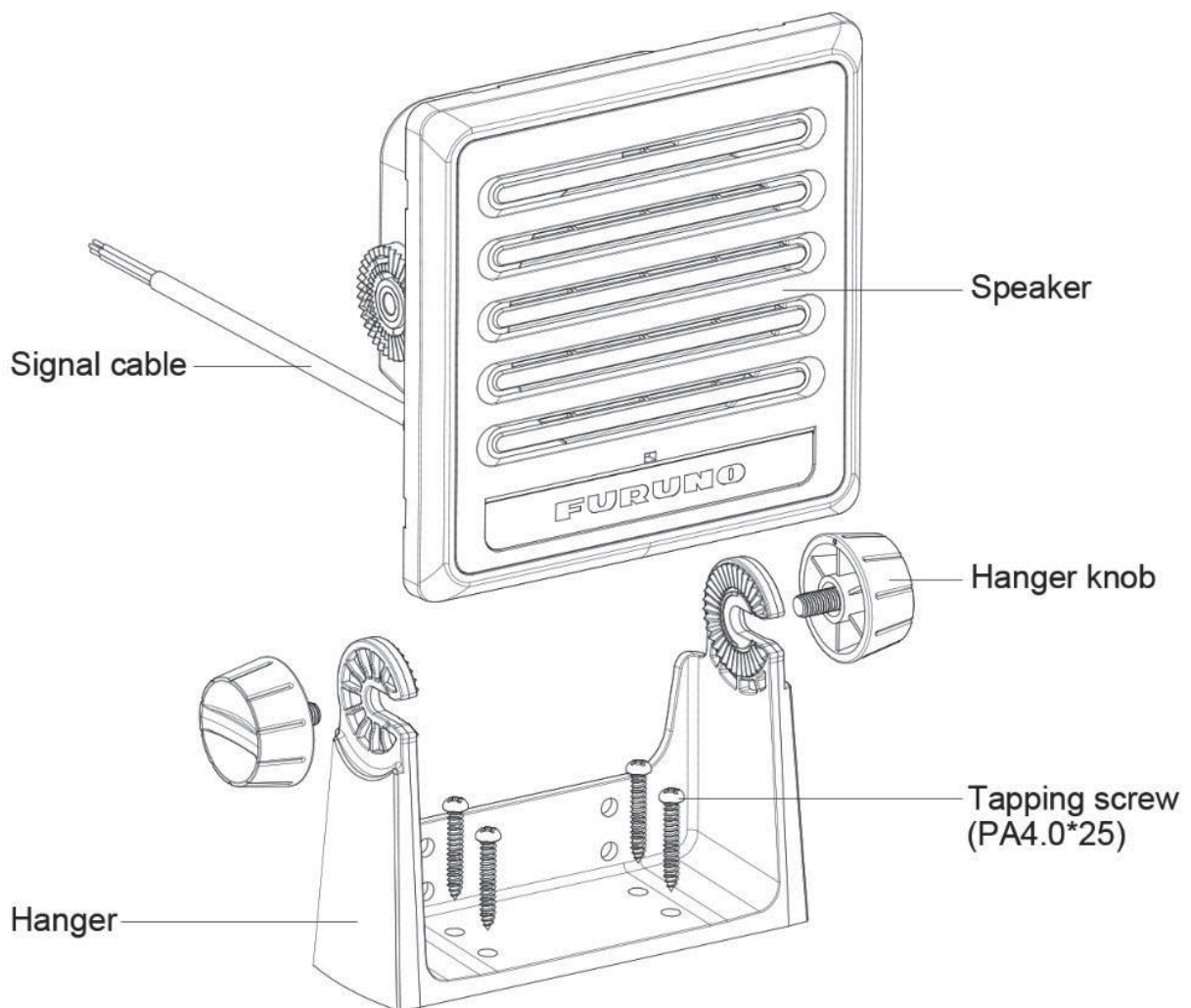

For flush mounting

- Step 1 Determine the position of installation holes according to the marking template and drill the hole.
- Step 2 Pry off the frame from the front panel.
- Step 3 Paste the installation sealing gasket on the back of the front panel.
- Step 4 Connect the speaker to the radio using the color-coded signal cable. Make sure that every signal cable is firmly connected.
- Step 5 Place the speaker in the hole and fix it with four screws.
- Step 6 Mount the frame.

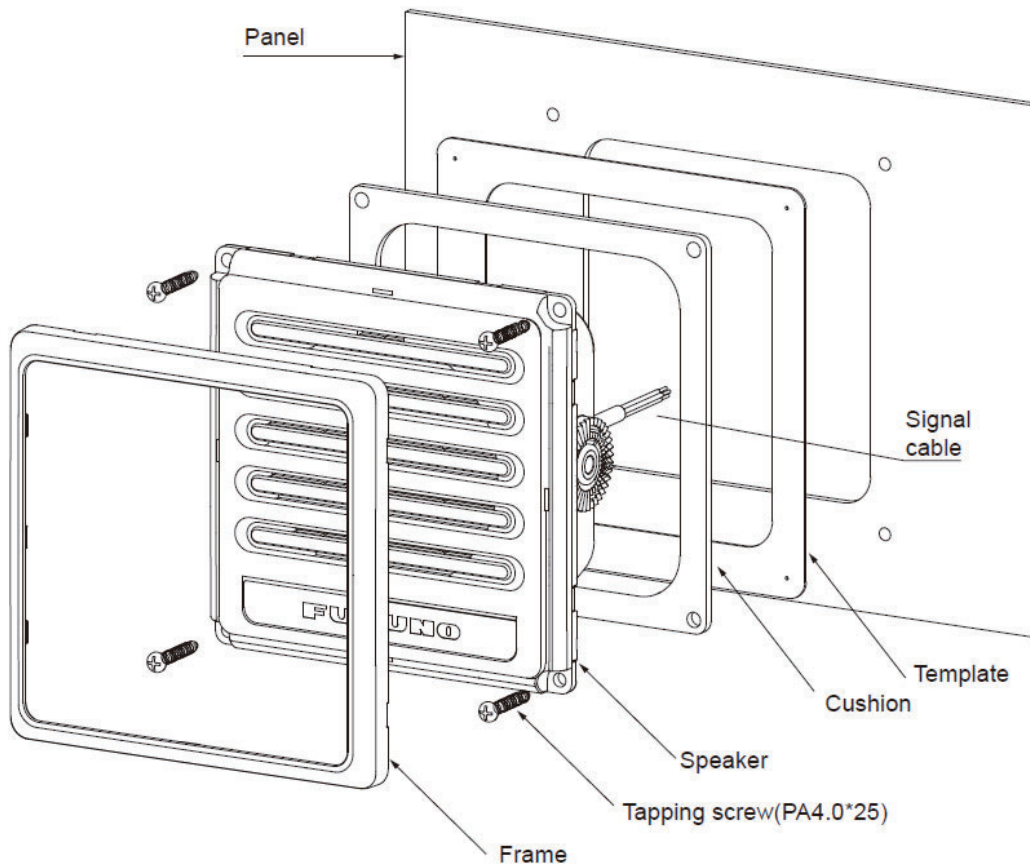

15.3 Wiring

15.3.1 Overview

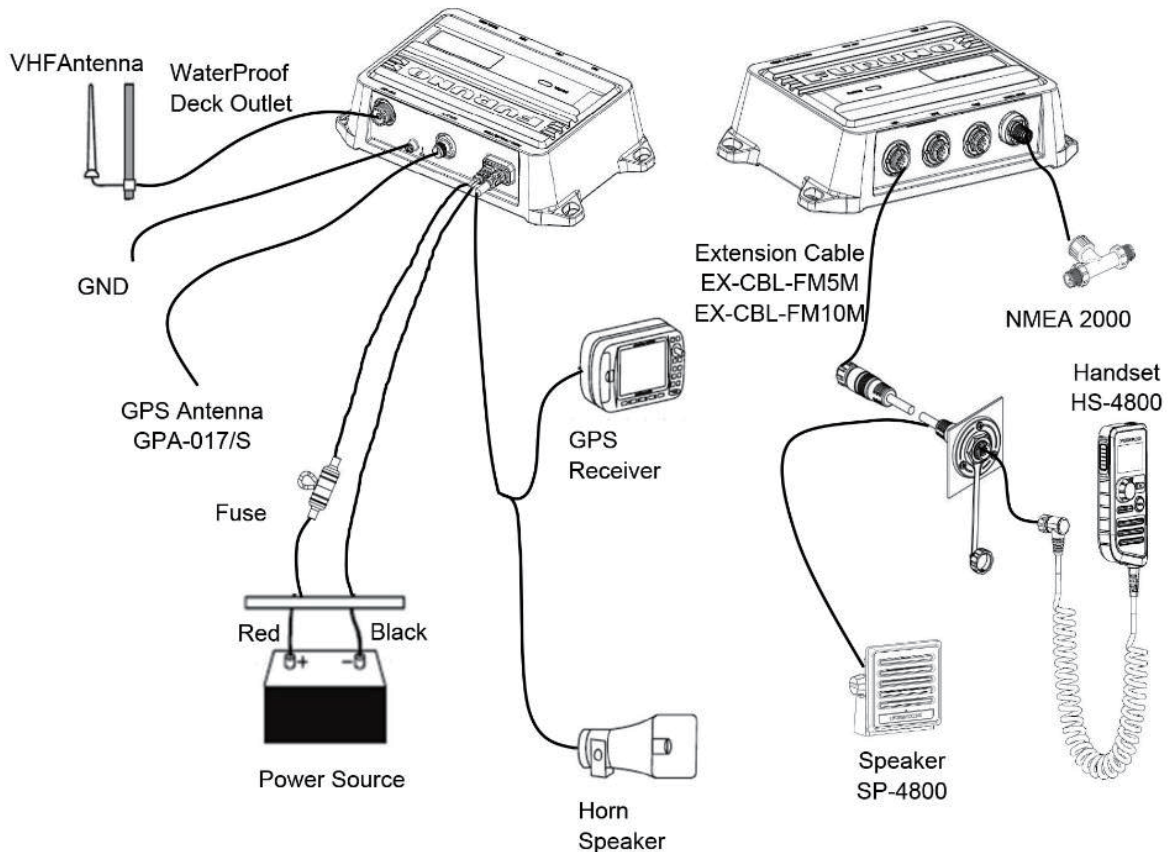

15.3.2 VHF Antenna

Requirements for the antenna

Any good quality antenna that meets the requirements shown below can be used.

- Frequency range: 155 to 164 MHz
- Impedance: 50 ohms
- Polarization: Vertical
- Handling power: 30 W or more
- Quality: Withstand the marine environment

Installation location

The location and installation of different antennas on a ship is important to ensure effective communications. Incorrectly installed antennas will degrade performance of the radio equipment and reduce the range of communications.

Select the location for the antenna considering the following points.

- VHF antennas should be placed in a position which is as elevated and free as possible, with at least 2 meters horizontal separation from constructions made by conductive materials.
- Ideally there should not be more than one antenna on the same level.
- The location of mandatory VHF antennas should be given priority compared with mobile telephone antennas. If they are located on the same level, the distance between them should be at least 5 meters.
- Isolate the antenna from all metallic parts of the ship.
- Current will overflow if the antenna touches any metal part of the ship.

Fabricating the Antenna Connector

- Step 1 Strip the RG58 cable according to the dimension in the following figure.
- Step 2 Put the antenna connector on the cable orderly.
- Step 3 Hold the flange between the insulation and the shield.
- Step 4 Tighten the nut.
- Step 5 Solder the connector and core.

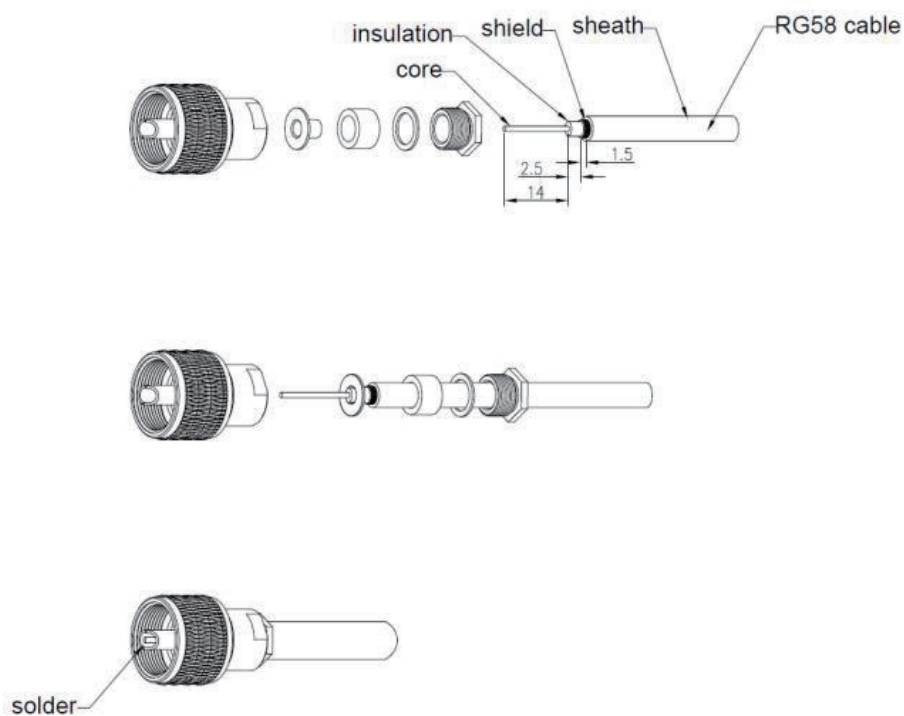

Wiring

- Step 1 Remove the antenna connector cover on the rear back of the unit.
- Step 2 Insert the antenna cable into the antenna connector.



- Step 3 Tighten the antenna hand tight.
- Step 4 Secure the cable with the electrical cable.

Waterproofing the Connection

To waterproof the connection, refer to the procedures outlined below. By waterproofing the connection, the IPx7 rating can be maintained.

- Step 1 Take the Self-bonding tape in the length of about 100 mm.
- Step 2 Connect the VHF antenna to the radio and tighten it clockwise.
- Step 3 Slightly stretch one end of the Self-bonding tape and wind it clockwise on the antenna head.
- Step 4 Wrap around the cable.



15.3.3 Ground Cable

- Step 1 Loosen the screw on the rear back of the unit.
- Step 2 Place the grounding wire on the screw.
- Step 3 Tighten the screw again.

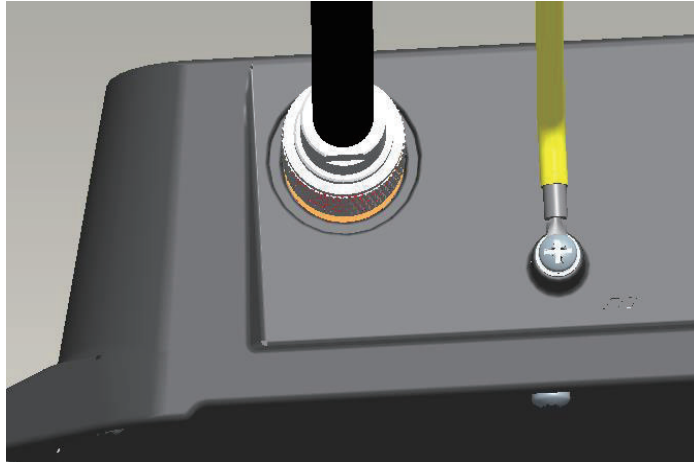

15.3.4 Power Cable

- Step 1 Remove the outer sheath at one end of the cable on the unit.

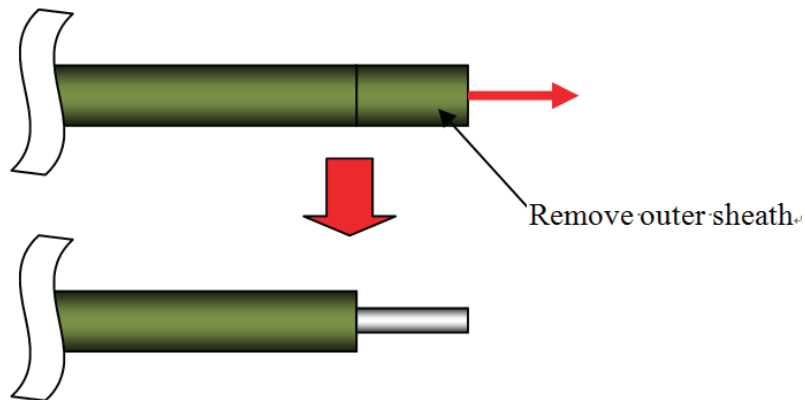

- Step 2 Referring to the figure below, place heat shrink tubes on the wires, and then solder the connection point.

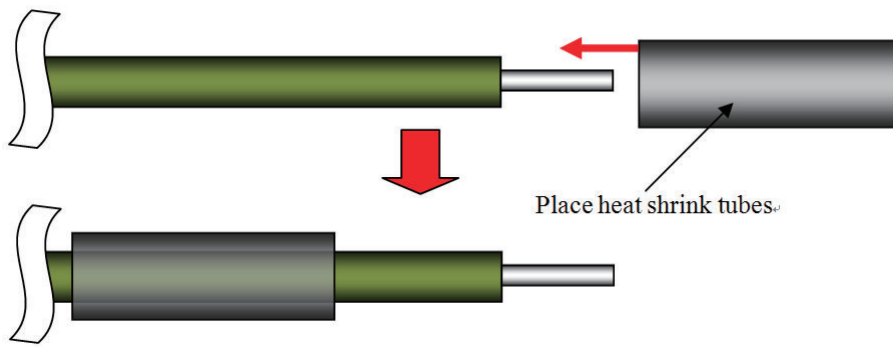

Step 3 Move the heat shrink tubes to the soldered connection, and then apply heat to the tubes.

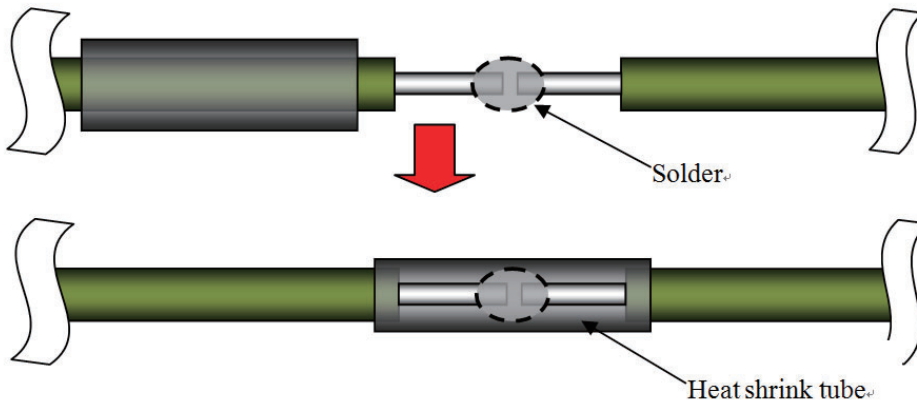

Step 4 Secure the cable with electrical tape.

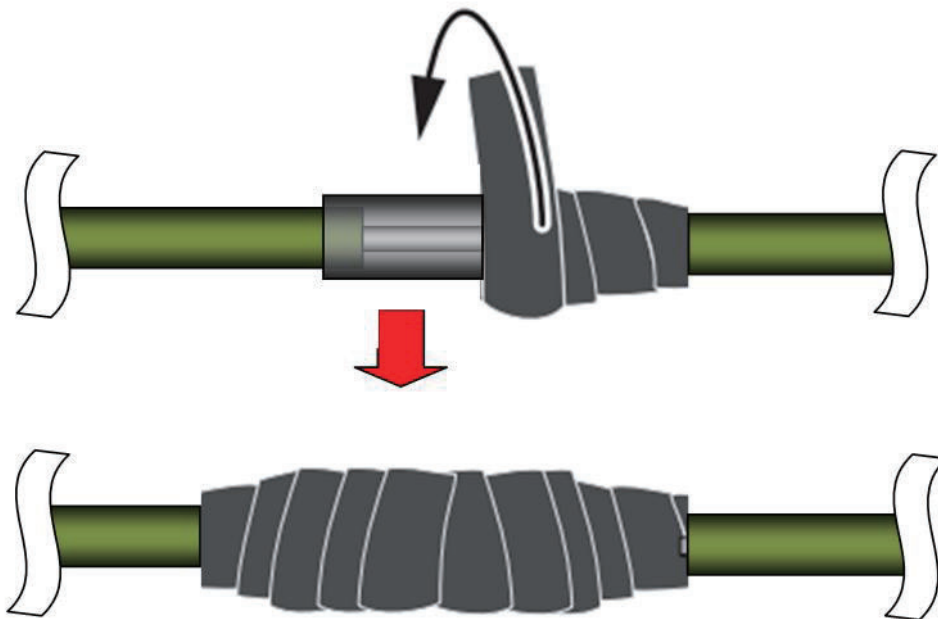

15.3.5 NMEA 0183 Wire

The NMEA 0183 wire can be used to connect the unit to a third-party GPS/GNSS receiver or multifunction display.

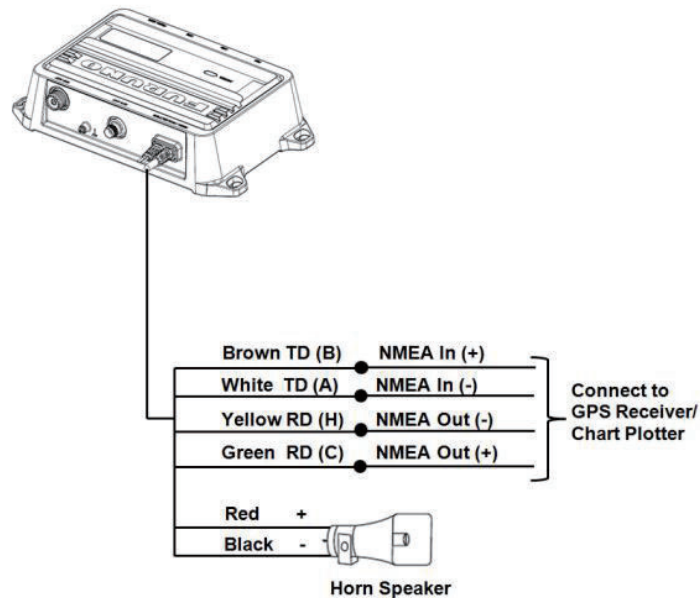

The NMEA 0183 wire should be connected to a compatible NEMA 0183 device as shown in the table below:

NEMA 0183 wires		NEMA 0183 device
Yellow –Receive positive (-)	to	Transmit positive (-)
Green–Receive negative (+)	to	Transmit negative (+)
White–Transmit positive (-)	to	Receive positive (-)
Brown–Transmit negative (+)	to	Receive negative (+)

 **Note**

Cover the connections with a waterproof tape or heat-shrink tubing.

 **Note**

Sensor source priority : Built in sensor > NMEA2000 > NMEA0183.

Baud rates : "AIS OUTPUT" is set to "ON" -> 38400 bps

"AIS OUTPUT" is set to "OFF" -> 4800 bps

15.3.6 Horn Speaker

You can connect the radio to a horn speaker to use the handset to make announcements.

- Step 1 If necessary, mount the horn speaker according to the installation instructions provided with the device.

 **Note**

To avoid feedback, you should mount the horn speaker at least 3 m (10 ft) away from, and facing away from, the handset.

- Step 2 Route or extend the wire from the horn speaker to the radio.
- Step 3 Connect the red wire on the radio wiring harness to the positive (+) wire from the speaker.
- Step 4 Connect the black wire on the radio wiring harness to the negative (-) wire from the speaker.
- Step 5 Cover the connections with a waterproof tape or heat-shrinking tubing.

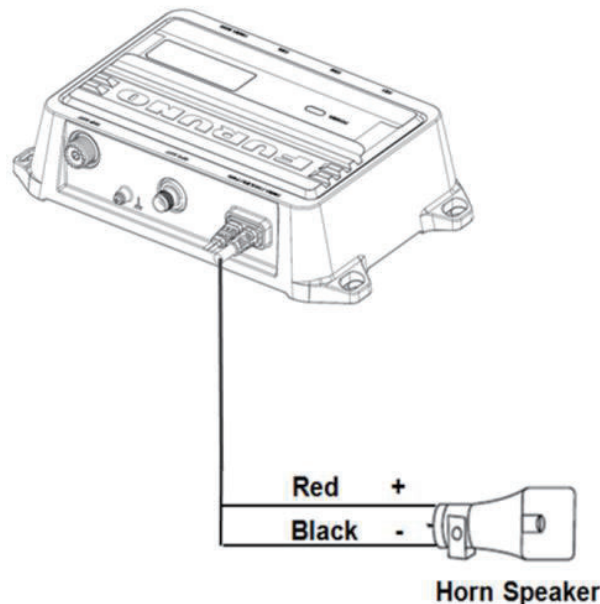

15.3.7 NMEA2000 Connector (CAN bus connector)

CAN bus is a communication protocol that shares multiple data and signals through a single backbone cable. You can simply connect any CAN bus devices onto the backbone cable to expand your network onboard. With CAN bus, IDs are assigned to all the devices in the network, and the status of each sensor in the network can be detected. All the CAN bus devices can be incorporated into the NMEA2000 network.

15.3.8 Extension Cable

- Step 1 Drill a round or square hole on the ship panel.
The diameter of the hole ranges from 23.5 mm to 25 mm.
- Step 2 Thread the extension cable through the hole.

- Step 3 Place the seal, cable holder, and waterproof cover sequentially around the extension cable.
- Step 4 Fasten the nut.
- Step 5 Fasten the three tapping screws.
- Step 6 Fasten the cover on the extension cable and tighten it.

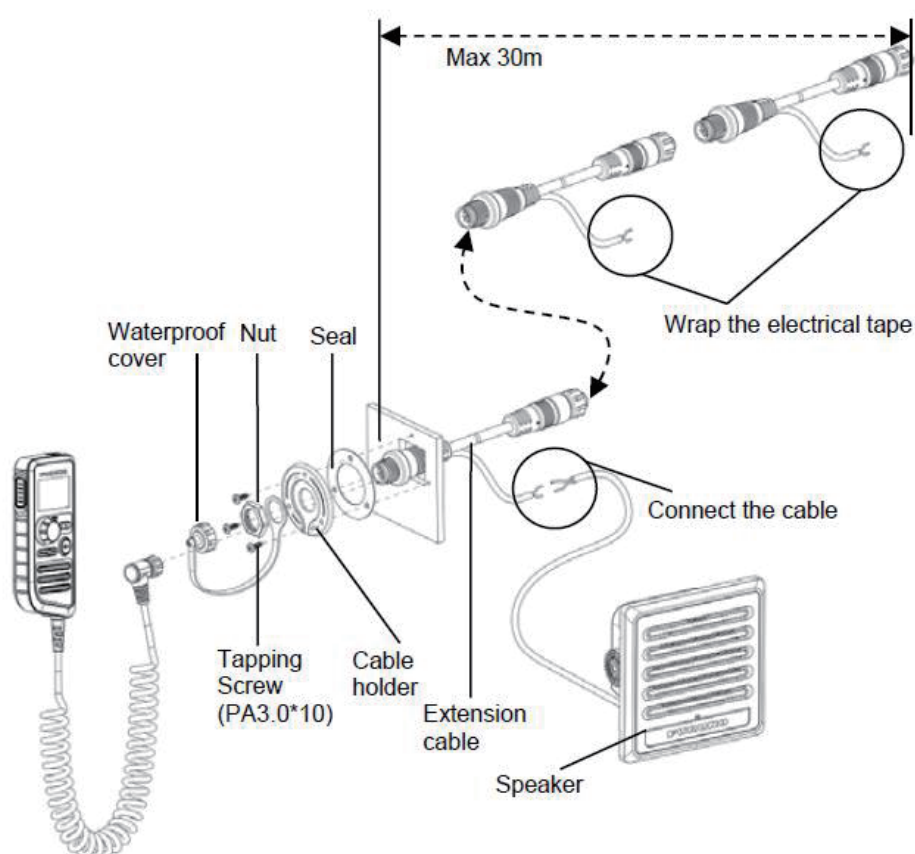

15.3.9 GPS Antenna

Install the antenna unit referring to the antenna installation diagram at the back of this manual. When choosing a mounting location for the antenna unit, keep in mind the following points:

- Select a location out of the radar beam. The radar beam will obstruct or prevent reception of the GPS signal.
- The location should be well away from a VHF/UHF antenna. A GPS receiver is interfered by a harmonic wave of a VHF/UHF antenna.
- There should be no interfering object within the line-of-sight to the satellites. An object within line-of-sight to satellites, for example, a mast, may block reception or prolong acquisition time.

- Mount the antenna unit as high as possible to keep it free from interfering objects and water spray. Freezing water can interrupt reception of the GPS satellite signal.

 **Note**

Do not shorten the antenna cable.

 **Note**

If the antenna cable is to be passed through a hole which is not large enough to pass the connector, unfasten the connector with a needle nose pliers and 3/8-inch open-end wrench. Refasten it as shown below, after running the cable through the hole.

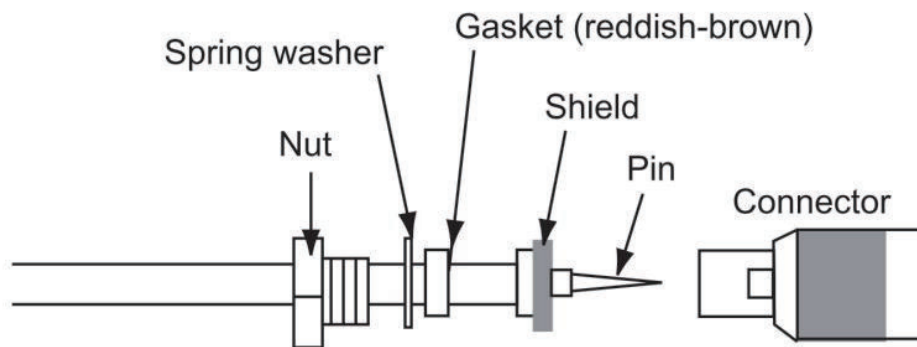

CHANNEL ASSIGNMENTS

The following channel charts are provided for your reference.

International Channel Chart

CH	TX (MHz)	RX (MHz)	Mode	Use
01	156.050	160.650	Duplex	Public Correspondence (marine operator)
02	156.100	160.700	Duplex	Public Correspondence (marine operator)
03	156.150	160.750	Duplex	Public Correspondence (marine operator)
04	156.200	160.800	Duplex	Public Correspondence (marine operator), Port Operations, Ship Movement
05	156.250	160.850	Duplex	Public Correspondence (marine operator), Port Operations, Ship Movement
06	156.300	156.300	Simplex	Inter-ship Safety
07	156.350	160.950	Duplex	Public Correspondence (marine operator), Port Operations, Ship Movement
08	156.400	156.400	Simplex	Commercial (inter-ship only)
09	156.450	156.450	Simplex	Boater calling channel, commercial & Non-commercial (recreational)
10	156.500	156.500	Simplex	Commercial
11	156.550	156.550	Simplex	Commercial, VTS in selected areas
12	156.600	156.600	Simplex	Port operation, VTS in selected areas
13	156.650	156.650	Simplex	Inter-ship navigation safety (bridge-to-bridge)
14	156.700	156.700	Simplex	Port operation, VTS in selected areas
15	156.750	156.750	Simplex	Environmental Low power (1 W) only
16	156.800	156.800	Simplex	International distress, safety and calling High power (25 W) initially
17	156.850	156.850	Simplex	State controlled Low power (1 W) only
18	156.900	161.500	Duplex	Port Operations, Ship Movement
19	156.950	161.550	Duplex	Port Operations, Ship Movement
20	157.000	161.600	Duplex	Port Operations
21	157.050	161.650	Duplex	Port Operations, Ship Movement
22	157.100	161.700	Duplex	Port Operations, Ship Movement
23	157.150	161.750	Duplex	Public Correspondence (marine operator)
24	157.200	161.800	Duplex	Public Correspondence (marine operator)
25	157.250	161.850	Duplex	Public Correspondence (marine operator)

CH	TX (MHz)	RX (MHz)	Mode	Use
26	157.300	161.900	Duplex	Public Correspondence (marine operator)
60	156.025	160.625	Duplex	Public Correspondence (marine operator)
61	156.075	160.675	Duplex	Public Correspondence (marine operator), Port Operations, Ship Movement
62	156.125	160.725	Duplex	Public Correspondence (marine operator), Port Operations, Ship Movement
63	156.175	160.775	Duplex	Public Correspondence (marine operator), Port Operations, Ship Movement
64	156.225	160.825	Duplex	Public Correspondence (marine operator), Port Operations, Ship Movement
65	156.275	160.875	Duplex	Public Correspondence (marine operator), Port Operations, Ship Movement
66	156.325	160.925	Duplex	Public Correspondence (marine operator), Port Operations, Ship Movement
67	156.375	156.375	Simplex	Commercial, used for bridge-to-bridge communications
68	156.425	156.425	Simplex	Non-commercial (recreational)
69	156.475	156.475	Simplex	Inter-ship, Port Operations and Ship Movement
70	156.525	156.525	Simplex	Digital selective calling (voice communications not allowed)
71	156.575	156.575	Simplex	Port Operations and Ship Movement
72	156.625	156.625	Simplex	Non-commercial (inter-ship only)
73	156.675	156.675	Simplex	Inter-ship, Port Operations and Ship Movement
74	156.725	156.725	Simplex	International: Inter-ship, Port Operations and Ship Movement
75	156.775	156.775	Simplex	Port operations (inter-ship only) Low power (1 W) only
76	156.825	156.825	Simplex	Port operations (inter-ship only) Low power (1 W) only
77	156.875	156.875	Simplex	Port operations (inter-ship only)
78	156.925	161.525	Duplex	Public Correspondence (marine operator), Port Operations, Ship Movement
79	156.975	161.575	Duplex	Port operation and Ship Movement
80	157.025	161.625	Duplex	Port operation, Ship Movement
81	157.075	161.675	Duplex	Port operation, Ship Movement
82	157.125	161.725	Duplex	Public Correspondence (marine operator), Port Operations, Ship Movement
83	157.175	161.775	Duplex	Public Correspondence (marine operator)
84	157.225	161.825	Duplex	Public Correspondence (marine operator)

CH	T X(MH z)	R X(MH z)	Mode	Use
85	157.275	161.875	Duplex	Public Correspondence (marine operator)
86	157.325	161.925	Duplex	Public Correspondence (marine operator)
87	157.375	157.375	Simplex	Port operation, Ship Movement
88	157.425	157.425	Simplex	Port operation, Ship Movement
1019	156.950	156.950	Simplex	Port Operations, Ship Movement
1020	157.000	157.000	Simplex	Port Operations, Ship Movement
1027	157.350	157.350	Simplex	
1028	157.400	157.400	Simplex	Port Operations, Ship Movement
1078	156.925	156.925	Simplex	Port Operations, Ship Movement
1079	156.975	156.975	Simplex	Port Operations, Ship Movement
2019	--	161.550	Simplex	Port Operations, Ship Movement(Receive only)
2020	--	161.600	Simplex	Port Operations, Ship Movement(Receive only)
2078	--	161.525	Simplex	Port Operations, Ship Movement(Receive only)
2079	--	161.575	Simplex	Port Operations, Ship Movement(Receive only)

Private Channel of international

CH	TX(MHz)	RX(MHz)	Mode	Use
96	162.425	162.425	Simplex	Belgium private channel Low power (1 W) only
L1	155.500	155.500	Simplex	Denmark/Finland/Norway/Sweden/ private channel
L2	155.525	155.525	Simplex	Denmark/Finland/Norway/Sweden/ private channel
L3	155.650	155.650	Simplex	Finland/Norway/Sweden/ private channel
F1	155.625	155.625	Simplex	Denmark/Finland/Norway/Sweden/ private channel
F2	155.775	155.775	Simplex	Denmark/Finland/Norway/Sweden/ private channel
F3	155.825	155.825	Simplex	Denmark/Finland/Norway/Sweden/ private channel
31	157.550	162.150	Duplex	Holland private channel
37	157.850	157.850	Simplex	Holland private channel
M1	157.850	157.850	Simplex	United Kingdom private channel
M2	161.425	161.425	Simplex	United Kingdom private channel

USA Channel Chart

CH	TX(MHz)	RX(MHz)	Mode	Use
1001	156.050	156.050	Simplex	Port Operations and Commercial, VTS. Available only in New Orleans / Lower Mississippi area.
1005	156.250	156.250	Simplex	Port Operations or VTS in the Houston, New Orleans and Seattle areas.
06	156.300	156.300	Simplex	Inter-ship Safety
1007	156.350	156.350	Simplex	Commercial. VDSMS
08	156.400	156.400	Simplex	Commercial (Inter-ship only). VDSMS
09	156.450	156.450	Simplex	Boater Calling. Commercial and Non-Commercial. VDSMS
10	156.500	156.500	Simplex	Commercial. VDSMS
11	156.550	156.550	Simplex	Commercial. VTS in selected areas. VDSMS
12	156.600	156.600	Simplex	Port Operations. VTS in selected areas.
13	156.650	156.650	Simplex	Inter-ship Navigation Safety (Bridge-to-bridge). Ships >20m length maintain a listening watch on this channel in US waters. Low power (1 W) initially Power override
14	156.700	156.700	Simplex	Port Operations. VTS in selected areas.
15	--	156.750	Duplex	Environmental (Receive only). Used by Class C EPIRBs.
16	156.800	156.800	Simplex	International Distress, Safety and Calling. Ships required to carry radio, USCG, and most coast stations maintain a listening watch on this channel. High power (25 W) initially
17	156.850	156.850	Simplex	State & local government maritime control Low power (1 W) only
1018	156.900	156.900	Simplex	Commercial. VDSMS
1019	156.950	156.950	Simplex	Commercial. VDSMS
20	157.000	161.600	Duplex	Port Operations (duplex)
1020	157.000	157.000	Simplex	Port Operations
1021	157.050	157.050	Simplex	U.S. Coast Guard only
1022	157.100	157.100	Simplex	Coast Guard Liaison and Maritime Safety Information Broadcasts. Broadcasts announced on channel 16.
1023	157.150	157.150	Simplex	U.S. Coast Guard only

CH	TX(MHz)	RX(MHz)	Mode	Use
24	157.200	161.800	Duplex	Public Correspondence (Marine Operator). VDSMS
25	157.250	161.850	Duplex	Public Correspondence (Marine Operator). VDSMS
26	157.300	161.900	Duplex	Public Correspondence (Marine Operator). VDSMS
27	157.350	161.950	Duplex	Public Correspondence (Marine Operator). VDSMS
28	157.400	162.000	Duplex	Public Correspondence (Marine Operator). VDSMS
1063	156.175	156.175	Simplex	Port Operations and Commercial, VTS. Available only in New Orleans / Lower Mississippi area.
1065	156.275	156.275	Simplex	Port Operations
1066	156.325	156.325	Simplex	Port Operations
67	156.375	156.375	Simplex	Commercial. Used for Bridge-to-bridge communications in lower Mississippi River. Inter-ship only. Low power (1 W) initially Power override
68	156.425	156.425	Simplex	Non-Commercial. VDSMS
69	156.475	156.475	Simplex	Non-Commercial. VDSMS
70	156.525	156.525	Simplex	Digital Selective Calling (voice communications not allowed)
71	156.575	156.575	Simplex	Non-Commercial. VDSMS Low power (1 W) initially Power override
72	156.625	156.625	Simplex	Non-Commercial (Inter-ship only). VDSMS
73	156.675	156.675	Simplex	Port Operations
74	156.725	156.725	Simplex	Port Operations
75	156.775	156.775	Simplex	Port Operations Low power (1 W) only
76	156.825	156.825	Simplex	Port Operations Low power (1 W) only
77	156.875	156.875	Simplex	Port Operations (Inter-ship only) Low power (1 W) only
1078	156.925	156.925	Simplex	Non-Commercial. VDSMS
1079	156.975	156.975	Simplex	Commercial. Non-Commercial in Great Lakes only. VDSMS

CH	TX(MHz)	RX(MHz)	Mode	Use
1080	157.025	157.025	Simplex	Commercial. Non-Commercial in Great Lakes only. VDSMS
1081	157.075	157.075	Simplex	U.S. Government only - Environmental protection operations.
1082	157.125	157.125	Simplex	U.S. Government only
1083	157.175	157.175	Simplex	U.S. Coast Guard only
84	157.225	161.825	Duplex	Public Correspondence (Marine Operator). VDSMS
85	157.275	161.875	Duplex	Public Correspondence (Marine Operator). VDSMS
86	157.325	161.925	Duplex	Public Correspondence (Marine Operator). VDSMS
87	157.375	157.375	Simplex	Public Correspondence (Marine Operator). VDSMS
88	157.425	157.425	Simplex	Commercial, Inter-ship only. VDSMS



Note
VDSMS (VHF Digital Small Message Services): Transmissions of short digital messages in accordance with RTCM Standard 12301.1 are allowed.

Canada Channel Chart

CH	TX(MHz)	RX(MHz)	Mode	Use
01	156.050	160.650	Duplex	Public Correspondence (Marine Operator)
02	156.100	160.700	Duplex	Public Correspondence (Marine Operator)
03	156.150	160.750	Duplex	Public Correspondence (Marine Operator)
04A	156.200	156.200	Simplex	Pacific coast: coast guard East coast: commercial fishing
05A	156.250	156.250	Simplex	Port Operations, VTS in Seattle
06	156.300	156.300	Simplex	Inter-ship safety
07A	156.350	156.350	Simplex	Commercial
08	156.400	156.400	Simplex	Commercial (inter-ship only)
09	156.450	156.450	Simplex	Boater calling channel, commercial & Non-commercial (recreational)
10	156.500	156.500	Simplex	Commercial
11	156.550	156.550	Simplex	Commercial, VTS in selected areas
12	156.600	156.600	Simplex	Port Operations, VTS in selected areas

CH	TX(MHz)	RX(MHz)	Mode	Use
13	156.650	156.650	Simplex	Inter-ship navigation safety (bridge-to-bridge)
14	156.700	156.700	Simplex	Port Operations, VTS in selected areas
15	156.750	156.750	Simplex	Commercial, non-commercial, Ship Movement Low power (1 W) only
16	156.800	156.800	Simplex	International distress, safety and calling High power (25 W) initially
17	156.850	156.850	Simplex	State controlled Low power (1 W) only
18A	156.900	156.900	Simplex	Commercial
19A	156.950	156.950	Simplex	Coast guard
20	157.000	161.600	Duplex	Canadian coast guard only
21A	157.050	157.050	Simplex	Canadian coast guard
21B	-	161.650	Duplex	(Receive only)
22A	157.100	157.100	Simplex	U.S. and Canadian coast guard liaison and maritime safety information broadcasts announced on channel 16
23	157.150	161.750	Duplex	Public Correspondence (Marine Operator)
23B	-	161.750	Duplex	(Receive only)
24	157.200	161.800	Duplex	Public Correspondence (Marine Operator)
25	157.250	161.850	Duplex	Public Correspondence (Marine Operator)
25B	-	161.850	Duplex	(Receive only)
26	157.300	161.900	Duplex	Public Correspondence (Marine Operator)
27	157.350	161.950	Duplex	Public Correspondence (Marine Operator)
28	157.400	162.000	Duplex	Public Correspondence (Marine Operator)
28B	-	162.000	Duplex	(Receive only)
60	156.025	160.625	Duplex	Public Correspondence (Marine Operator)
61A	156.075	156.075	Simplex	Public coast: coast guard East coast: commercial fishing only
62A	156.125	156.125	Simplex	Public coast: coast guard East coast: commercial fishing only
63A	156.175	156.175	Simplex	Port Operations and commercial VTS in selected areas
64	156.225	160.825	Duplex	Public Correspondence (Marine Operator), Port Operations, Ship Movement

CH	TX(MHz)	RX(MHz)	Mode	Use
64A	156.225	156.225	Simplex	Public Correspondence (Marine Operator), Port Operations, Ship Movement
65A	156.275	156.275	Simplex	Port Operations
66A	156.325	156.325	Simplex	Port Operations
67	156.375	156.375	Simplex	U.S.: Commercial, used for bridge-to-bridge communications in lower Mississippi River, inter-ship only Canada: commercial fishing, S&R
68	156.425	156.425	Simplex	Non-commercial (recreational)
69	156.475	156.475	Simplex	U.S.: non-commercial (recreational) Canada: commercial fishing only International: inter-ship, port Operations and Ship Movement
70	156.525	156.525	Simplex	Digital selective calling (voice communications not allowed)
71	156.575	156.575	Simplex	U.S. and Canada: non-commercial (recreational) International: Port Operations and Ship Movement
72	156.625	156.625	Simplex	Non-commercial (inter-ship only)
73	156.675	156.675	Simplex	Commercial fishing only
74	156.725	156.725	Simplex	Commercial fishing only
75	156.775	156.775	Simplex	Port Operations (inter-ship only) Low power (1 W) only
76	156.825	156.825	Simplex	Port Operations (inter-ship only) Low power (1 W) only
77	156.875	156.875	Simplex	Port Operations (inter-ship only) Low power (1 W) only
78A	156.925	156.925	Simplex	Non-commercial (recreational)
79A	156.975	156.975	Simplex	Commercial
80A	157.025	157.025	Simplex	Commercial
81A	157.075	157.075	Simplex	Canadian coast guard only
82A	157.125	157.125	Simplex	Canadian coast guard only
83A	157.175	157.175	Simplex	Canadian coast guard only
83B	-	161.775	Duplex	(Receive only)
84	157.225	161.825	Duplex	Public Correspondence (Marine Operator)
85	157.275	161.875	Duplex	Public Correspondence (Marine Operator)
86	157.325	161.925	Duplex	Public Correspondence (Marine Operator)
87	157.375	157.375	Simplex	Port Operations, Ship Movement

CH	TX(MHz)	RX(MHz)	Mode	Use
88	157.425	157.425	Simplex	Port Operations, Ship Movement

Weather Channel Chart (Only USA and Canada)

CH	TX(MHz)	RX(MHz)	Mode	Use
WX01	-	162.550		Weather (receive only)
WX02	-	162.400		Weather (receive only)
WX03	-	162.475		Weather (receive only)
WX04	-	162.425		Weather (receive only)
WX05	-	162.500		Weather (receive only)
WX06	-	162.525		Weather (receive only)
WX07	-	162.650		Weather (receive only)
WX08	-	161.650		Weather (receive only)
WX09	-	161.775		Weather (receive only)
WX10	-	163.275		Weather (receive only)

MENU TREE

MAIN MENU

Bold Italic: Default, Under Line: "FACTORY RESET" items

- └ DSC CALL
 - | └ INDIVIDUAL (DIRECTORY, RECENT CALLS, MANUAL ID)
 - | └ GROUP (DIRECTORY, RECENT CALLS, MANUAL ID)
 - | └ ALL SHIPS (SAFETY, URGENCY)
 - | └ POS REQUEST (DIRECTORY, RECENT CALLS, MANUAL ID)
 - | └ AUTO POS POLLING
 - | └ ACTIVATION (START, **STOP**)
 - | └ SELECT ADDRESS
 - | └ MONITOR POSITION
 - | └ DSC LOG
 - | └ (RX DISTRESS LOG, RX POS REQ LOG, RX OTHER LOG, TX LOG,
TX ACK LOG)
 - | └ DSC TEST (DIRECTORY, RECENT CALLS, MANUAL ID)
- └ CH WATCH
 - | └ DUAL CH
 - | └ TRIPLE CH
- └ SCAN
 - | └ SCAN ALL
 - | └ SCAN ALL+16
 - | └ MEMORY SCAN
 - | └ MEMORY SCAN+16
 - | └ EDIT MEMORY CH (**ALL OFF**)
- └ WEATHER MODE
- └ FOG/HAILER/IC
 - | └ FOG HORN
 - | └ MANUAL HORN
 - | └ MANUAL YELP
 - | └ AUTO FOG MODE (**UNDERWAY**, STOPPED, SAILBOAT, TOWED,
ANCHORED, AGROUND)
 - | └ HAILER
 - | └ INTERCOM
 - | └ EDIT HANDSET NAME
- └ SET MMSI
- └ GENERAL SETUP
 - | └ DISPLAY SETUP
 - | └ BACKLIGHT (OFF, 1 to 8, MAX, **5**)
 - | └ CONTRAST (MIN, 1 to 8, MAX, **5**)
 - | └ UNITS
 - | └ TIME FORMAT (**12 HOUR**, 24 HOUR)

- | | | | TIME OFFSET (-13 to +13, **0**)
- | | | | SPEED (***KNOTS***, MILE/HOUR, KILOMETER/HOUR)
- | | | | | BEARING (TRUE, ***MAGNETIC***)
- | | | KEY BEEP (OFF, ***LEVEL1***, LEVEL2, LEVEL3, MAX)
- | | GNSS SETUP
 - | | | INTERNAL GNSS (***ON***, OFF)
 - | | | COG/SOG DISPLAY (***ON***, OFF)
 - | | | | MANUAL POSITION
- | | WEATHER ALERT (ON, ***OFF***)
- | | I/O PORT SETUP
 - | | | SELECT OUTPUT PORT (***NMEA2000***, NMEA0183)
 - | | | GNSS OUTPUT (ON, ***OFF***)
 - | | | DSC OUTPUT (***ON***, OFF)
 - | | | | AIS OUTPUT (ON, ***OFF***)
- | | SYSTEM INFO
 - | | | SOFTWARE VERSION (OWN UNIT, ALL UNIT)
 - | | | DIAGNOSTIC TEST
 - | | | | FACTORY RESET
- | | FOG HORN FREQ (200Hz to 850Hz, ***400Hz***)
 - | | | SERVICE MENU (Requires key code access. For service personnel only)
- | CH FUNCTION SETUP
 - | | CH GROUP (***INTERNATIONAL***, USA, CANADA)
 - | | 2ND PRIORITY (***CH 09***)
 - | | EDIT CH NAME
 - | | | PRIVATE CH (NONE, BELGIUM, DK LEISURE, DK FISH, FI LEISURE, FI FISH, HOLLAND, NOR LEISURE, NOR FISH, SW LEISURE, SW FISH, UK)
- | DSC SETUP
 - | | INDIV DIRECTORY
 - | | GROUP DIRECTORY
 - | | AUTO CHANGE CH (MANUAL, ***AUTO***)
 - | | INDIVIDUAL ACK (***MANUAL***, AUTO)
 - | | POSITION ACK (***MANUAL***, AUTO, IGNORE)
 - | | TEST ACK (MANUAL, ***AUTO***)
 - | | AUTO POS INTERVAL
 - | | | (***1MIN***, 2MIN, 3MIN, 4MIN, 5MIN, 10MIN, 20MIN, 30MIN, 40MIN)
 - | | | TIMEOUT
 - | | | | NON DISTRESS (***15MIN***, NO TIMEOUT)
 - | | | | | RX DISTRESS (15 MIN, ***NO TIMEOUT***)
 - | | | ALARM
 - | | | | SAFETY (***ON***, OFF)
 - | | | | | ROUTINE (***ON***, OFF)
- | ATIS SETUP

- └ ATIS (ON, **OFF**)
- └ SET ATIS ID

SQUELCH (OFF, 1 to 8, MAX, **3**)

VOLUME (OFF, 1 to 14, MAX, **1**)

FOG HORN VOLUME (OFF, 1 to 14, MAX, **1**)

HAILER TAKING VOLUME (OFF, 1 to 14, MAX, **1**)

HAILER LISTENING VOLUME (OFF, 1 to 14, MAX, **1**)

INTERCOM VOLUME (OFF, 1 to 14, MAX, **1**)

SPECIFICATIONS

1. GENERAL

1.1 Channels	International, USA and Canada
1.2 Frequency stability	With ± 1.5 kHz
1.3 Communication system	Simplex / Semi-duplex
1.4 Antenna impedance	50 ohms
1.5 Display	Monochrome, 192×128 dot (HS-4800)

2. TRANSMITTER

2.1 Frequency Range	155.500 MHz to 162.425 MHz
2.2 Output power	25W max., 1W at power reduction
2.3 Frequency deviation	± 5 kHz max.
2.4 Spurious emission	Standby: less than 2nW Transmit: less than 0.25 μ W
2.5 Modulation	16K0G3E(F3E) Voice, 16K0G2B(F2B) DSC

3. RECEIVER

3.1 Frequency Range	155.500 MHz to 162.425 MHz
Frequency range of Weather Channel	162.550 MHz to 163.275 MHz (Only USA and Canada)
3.2 Sensitivity	+6 dB μ V(e.m.f) or less (SINAD 20dB)
3.3 Channel selectivity	70dB or more
3.4 Spurious response	70dB or more

4. DSC receiver

4.1 Protocol	Class D DSC
4.2 Sensitivity	0 dB μ V(e.m.f) or less (BER < 1%)
4.3 Channel selectivity	70dB or more
4.4 Spurious response	70dB or more

5. AIS receiver

5.1 Receiver frequency (CH)	161.975 MHz (AIS1), 162.025 MHz (AIS2)
5.2 Sensitivity	-107 dBm or less (PER < 20%)
5.3 Channel selectivity	70dB or more
5.4 Spurious response	70dB or more

6. GNSS receiver

6.1 Receiving Frequency	GPS L1 C/A
6.2 Number of channel	72 channels
6.3 Accuracy	10m
6.4 Position fixing time (cold start)	120 sec typical
6.5 Position update interval	1 sec

7. SPEAKER POWER OUTPUT

7.1 Handset	1W (16ohm)
7.2 Speaker	3W (8ohm)
7.3 Hailer speaker	30W max. (4 ohm) 15W (4 ohm, 1kHz, 12.0V, 10% distortion)

8. INTERFACE

8.1 Number of port	NMEA0183 1 port, NMEA2000 1 port
--------------------	----------------------------------

8.2 NMEA0183 [Sentence]

Input * DTM, GGA, GLL, GNS, RMA, RMC

*: When RMA is input to the equipment, do not input GGA, GLL, GNS or RMC.
When RMA and any of those sentences are input to the equipment, the positioning time of those sentences is displayed as that of the RMA and the positioning time of RMA is not displayed.

Output DSC, DSE, GLL, RMC, VDM

8.3 NMEA0183 [Load requirements as a listener]

Isolation	Opto-coupler
Input impedance	520ohm
Max. voltage	±15V
Threshold	1.3mA

8.4 NMEA0183 [Output drive capability]

R=54 ohm, 1.5V min.

Short circuit output current : ±250mA

8.5 NMEA2000 [PGN]

Input 059392/904, 060160/416/928, 065240, 126208,
127258, 129026/029/044

Output 059392, 060928, 126208/464/993/996/998,
126992, 127258,
129025/026/029/038/039/040/041/540/793/794,
129795/797/798/801/802/808/809/810

9. POWER SUPPLY

9.1 Power voltage	12.0 V DC (-10%, + 30%)
9.2 Power consumption	Transmit : 5 A (at 25W output, with all options) Receive : 2.5 A (at 3W audio output) Standby : 1 A





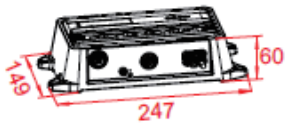
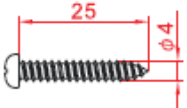
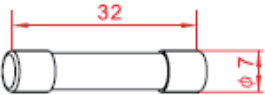
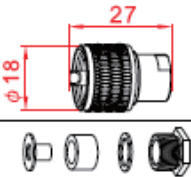
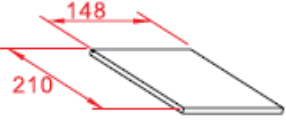
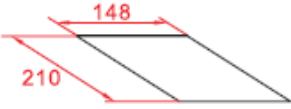
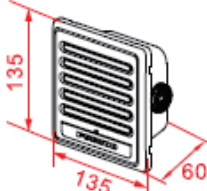
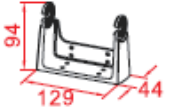
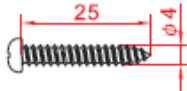

10. ENVIRONMENTAL CONDITION

10.1 Ambient temperature	-15°C to +55°C
10.2 Relative humidity	93% or less at +40°C
10.3 Degree of protection	IP67 (FM-4850, HS-4800, SP-4800)

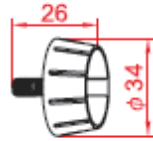
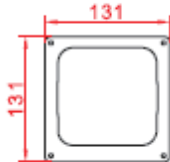
PACKING LIST

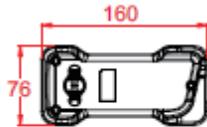
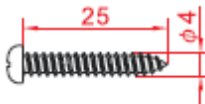
FM-4850 PACKING LIST

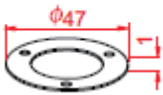
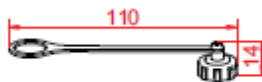
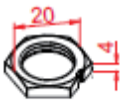
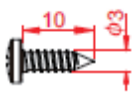

NAME	OUTLINE	DESCRIPTION	Q'TY
RADIO TELEPHONE			
BLACK BOX		FM-4850	1
TAPPING SCREW			4
TUBE FUSE		250VAC 8A	2
UHF CONNECTOR			1
OPERATOR'S MANUAL			1
Contents of Hazardous Substances or Elements of products			1
SPEAKER			
SPEAKER		SP-4800	1
HANGER			1
TAPPING SCREW			4

NAME	OUTLINE	DESCRIPTION	Q'TY
HANGER KNOB			2
CUSHION			1
TEMPLATE			1
HANDSET			
HANDSET		HS-4800	1
HANGER			1
TAPPING SCREW			3
CABLE HOLDER			1
SEAL			1
WATERPROOF COVER			1
SEAL			1
TAPPING SCREW			3
EXTENSION CABLE		EX-CBL-FM5M	1

DIMENSIONS IN DRAWING FOR REFERENCE ONLY.

5202990060205A

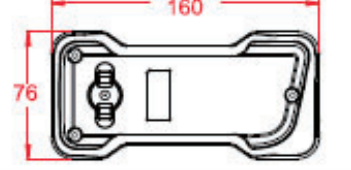
HS-4800 PACKING LIST

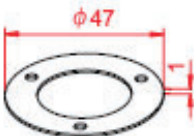
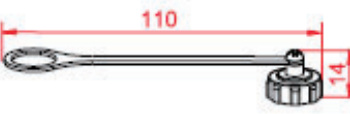
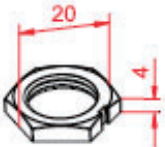
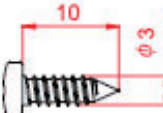
NAME	OUTLINE	DESCRIPTION/CODE No.	Q'TY
UNIT			
HANDSET		HS-4800	1
HANGER SET			
HANGER		/	1
TAPPING SCREW		/	3
ACCESSORIES			
CABLE HOLDER		/	1
SEAL		/	1
WATERPROOF COVER		/	1
NUT		/	1
TAPPING SCREW		/	3

DIMENSIONS IN DRAWING FOR REFERENCE ONLY.

SP-4800 PACKING LIST

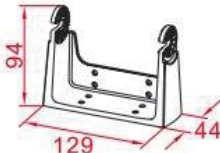
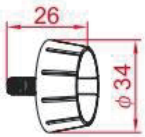
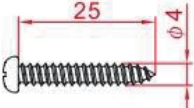
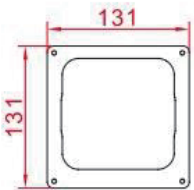
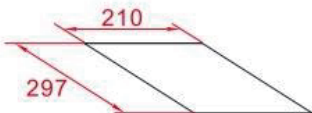
NAME	OUTLINE	DESCRIPTION	Q'TY
UNIT			
INTERCOM SPEAKER		SP-4800	1
ACCESSORIES			
HANGER		/	1
HANGER KNOB		/	2
TAPPING SCREW		/	4
FLUSH MOUNTING MATERIALS			
CUSHION		/	1
TEMPLATE		/	1

DIMENSIONS IN DRAWING FOR REFERENCE ONLY.

5202990000097B

OUTLINE DRAWINGS

FM-4850 Desktop mounting and wall mounting

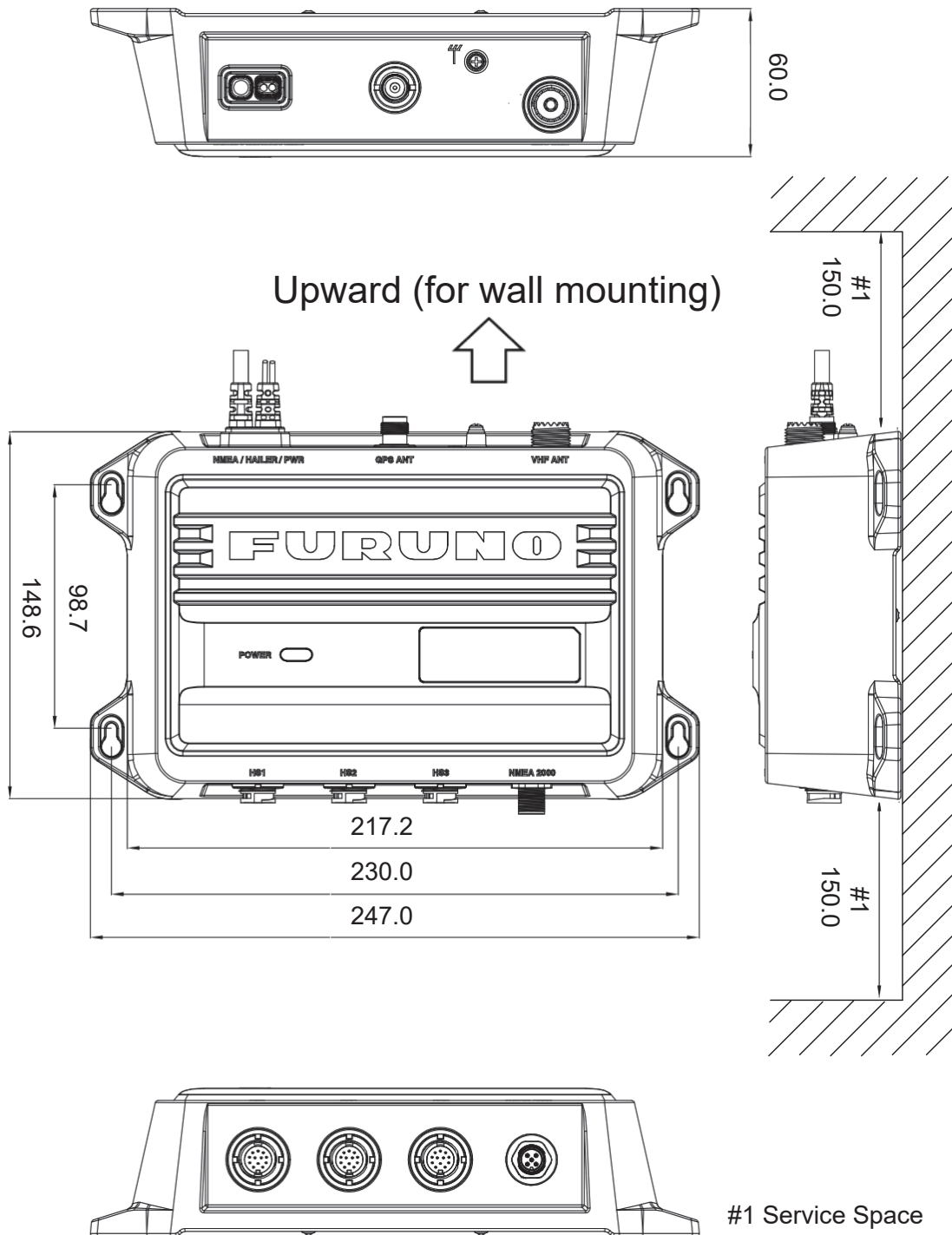

Weight: 1.75 kg

HS-4800

Desktop mounting and wall mounting

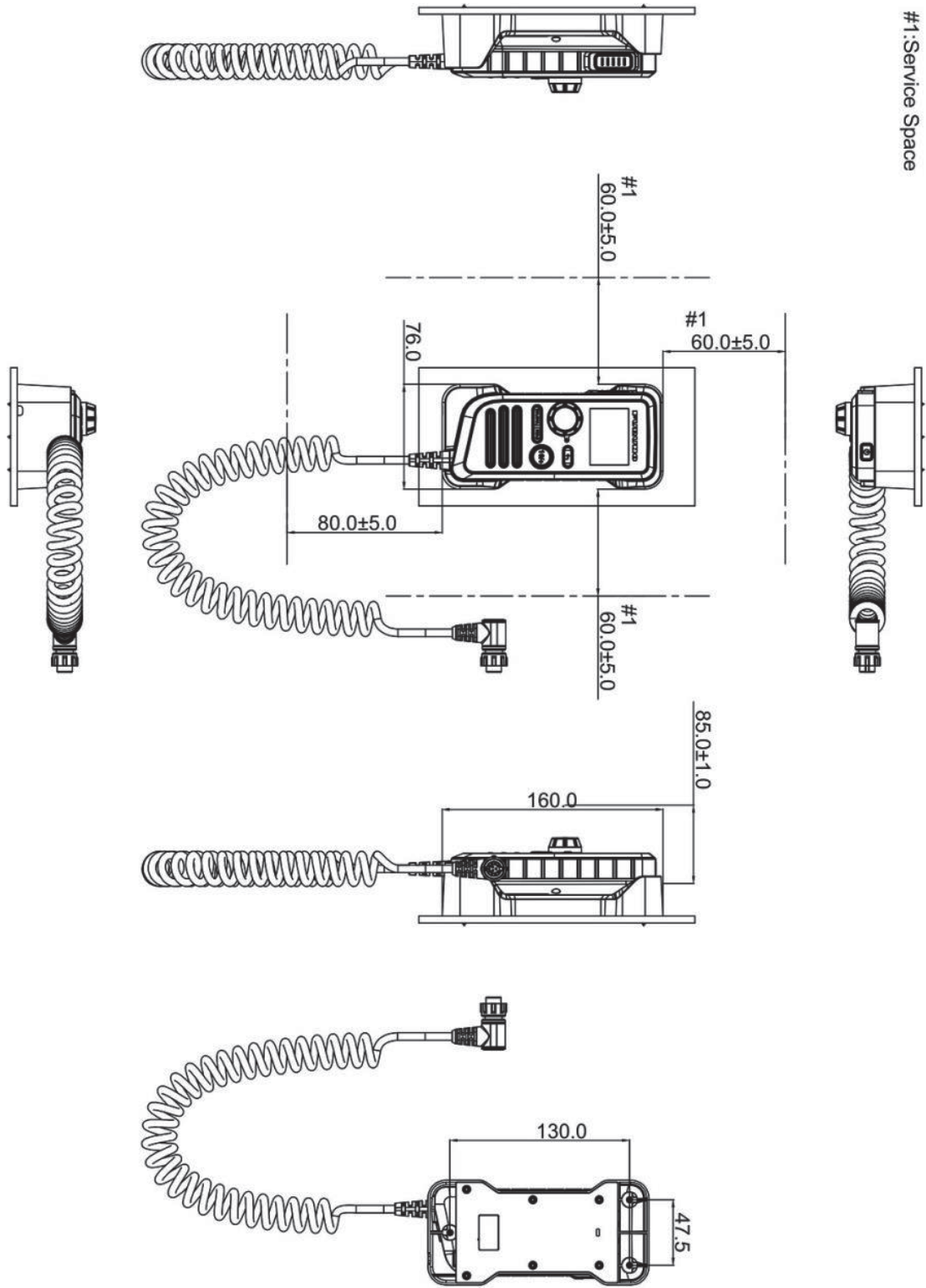

Weight: 0.3 kg

SP-4800
Desktop mounting

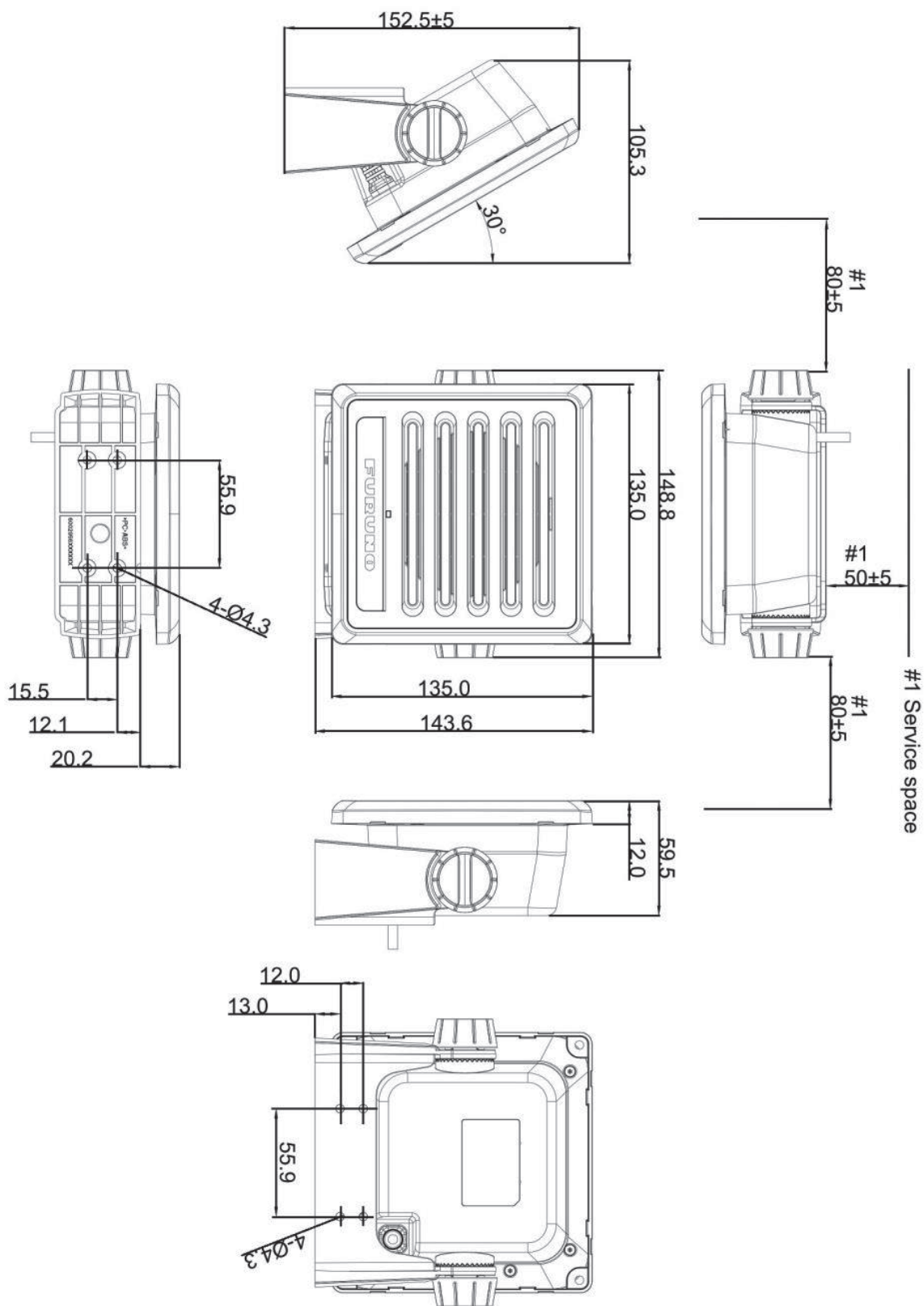

Weight: 0.76 kg

SP-4800 Flush mounting

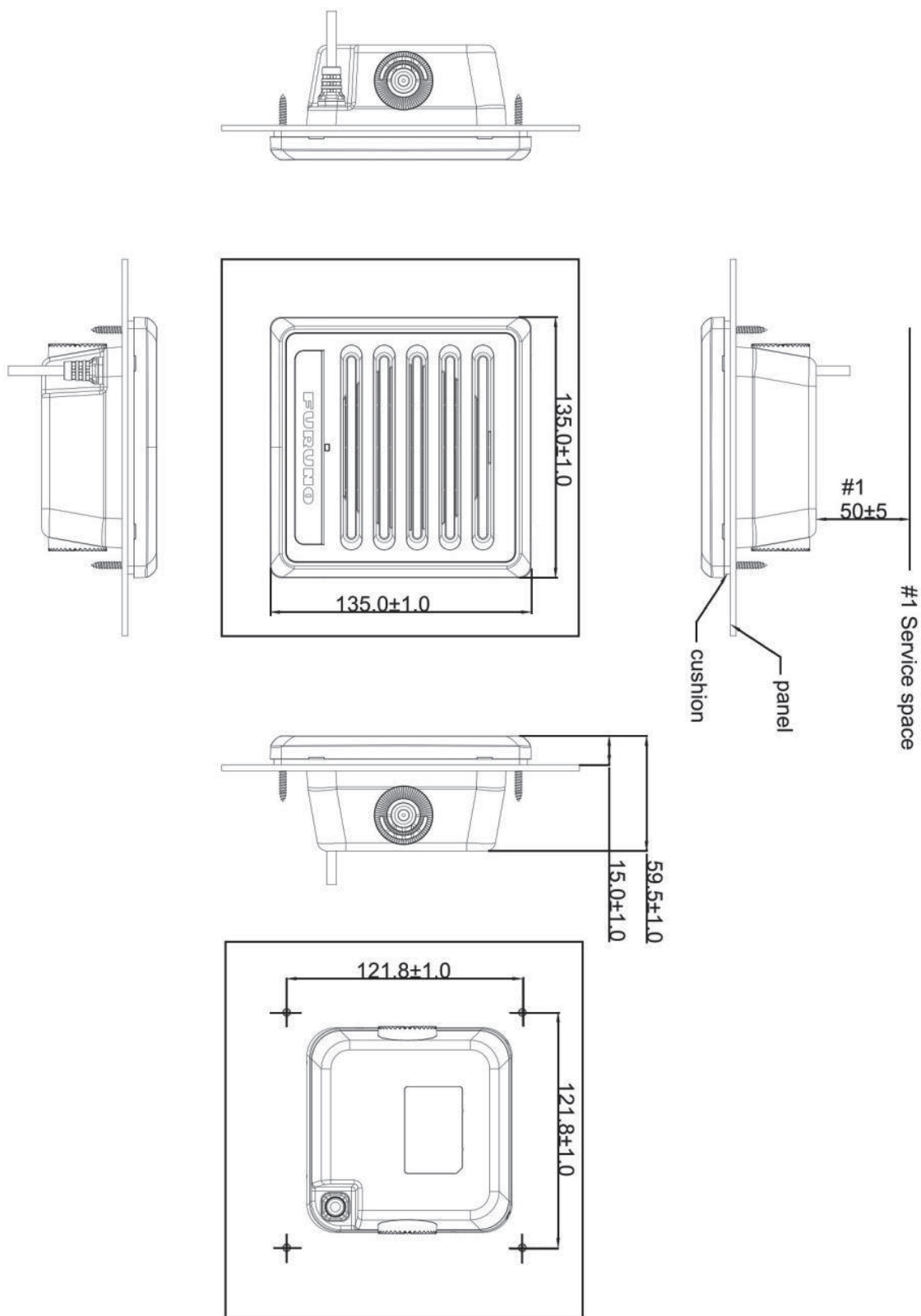

Weight: 0.76 kg

FURUNO

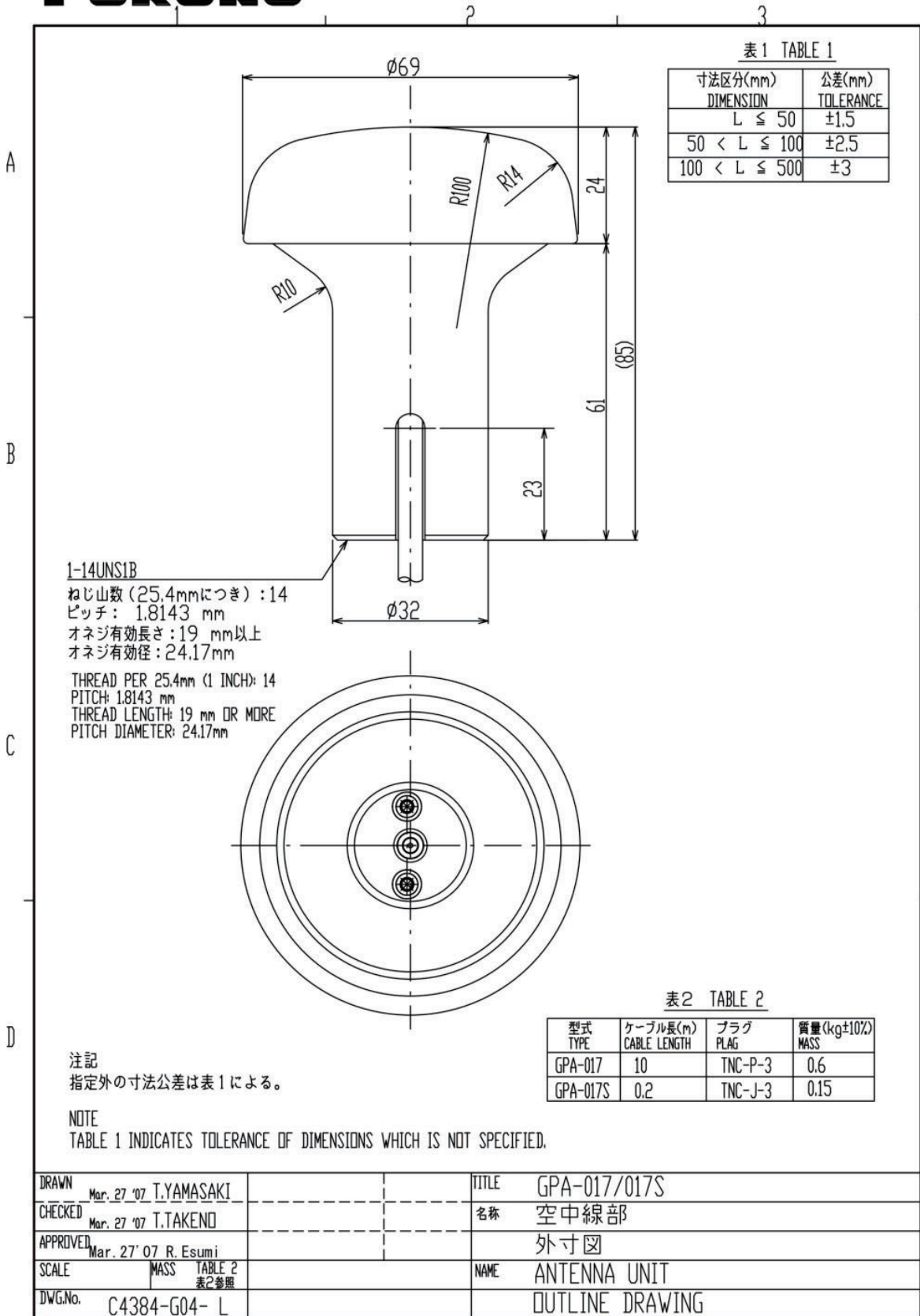

FURUNO ELECTRIC CO., LTD.

INTERCONNECTION

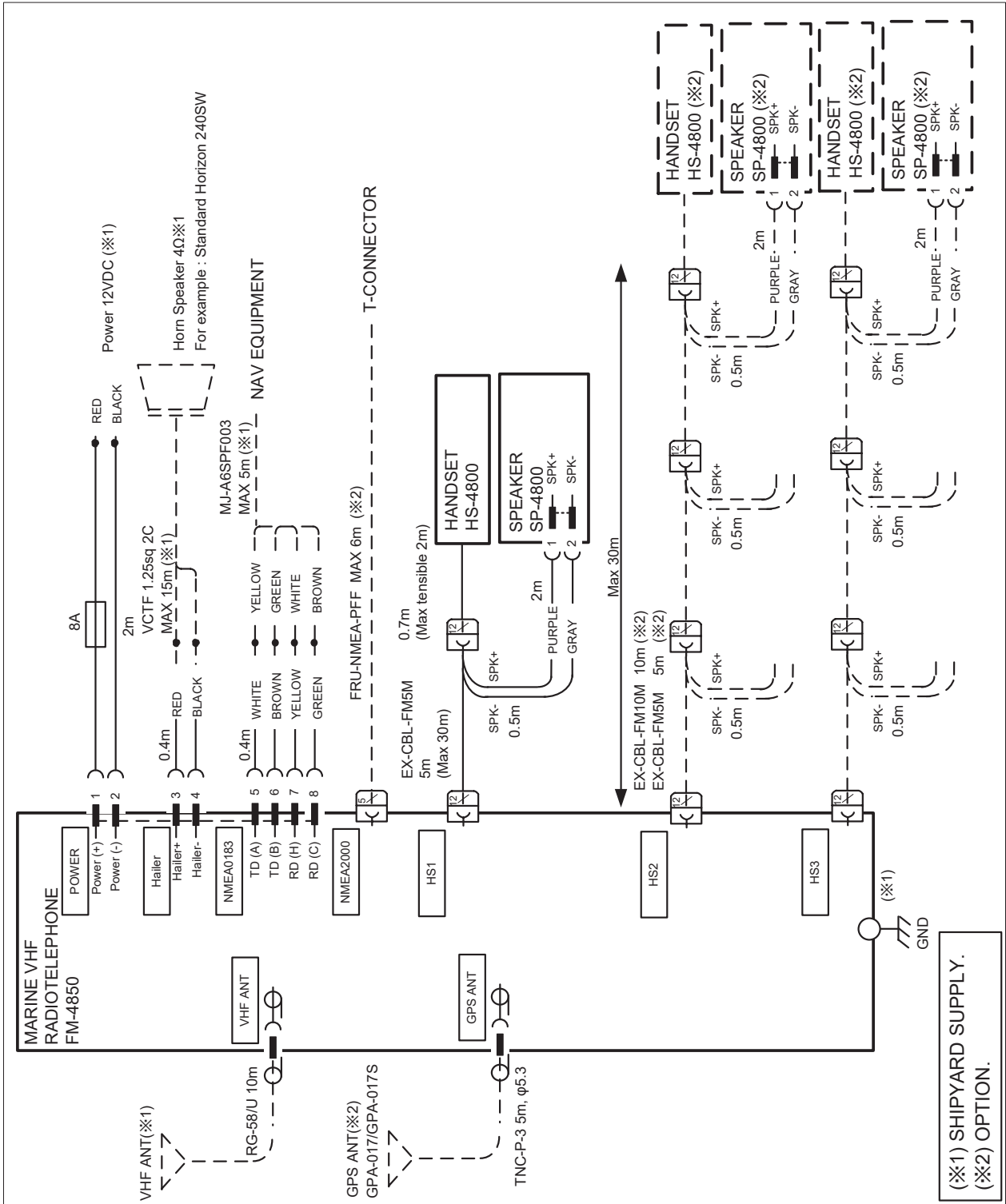

TOOLS

No.	Name	No.	Name
1	Diagonal pliers	10	Utility knife
2	Philips screwdriver	11	Wire stripper
3	Flathead screwdriver	12	Electric iron
4	Adjustable wrench	13	Heat-shrink tube
5	Heat gun	14	Waterproof adhesive tape
6	Marker	15	Electric drill
7	Multimeter	16	Drill
8	ESD-preventive gloves	17	Electric saw
9	ESD-preventive wrist strap	\	\

FURUNO

ISP-5000/SP-4800 Flush Mount Template

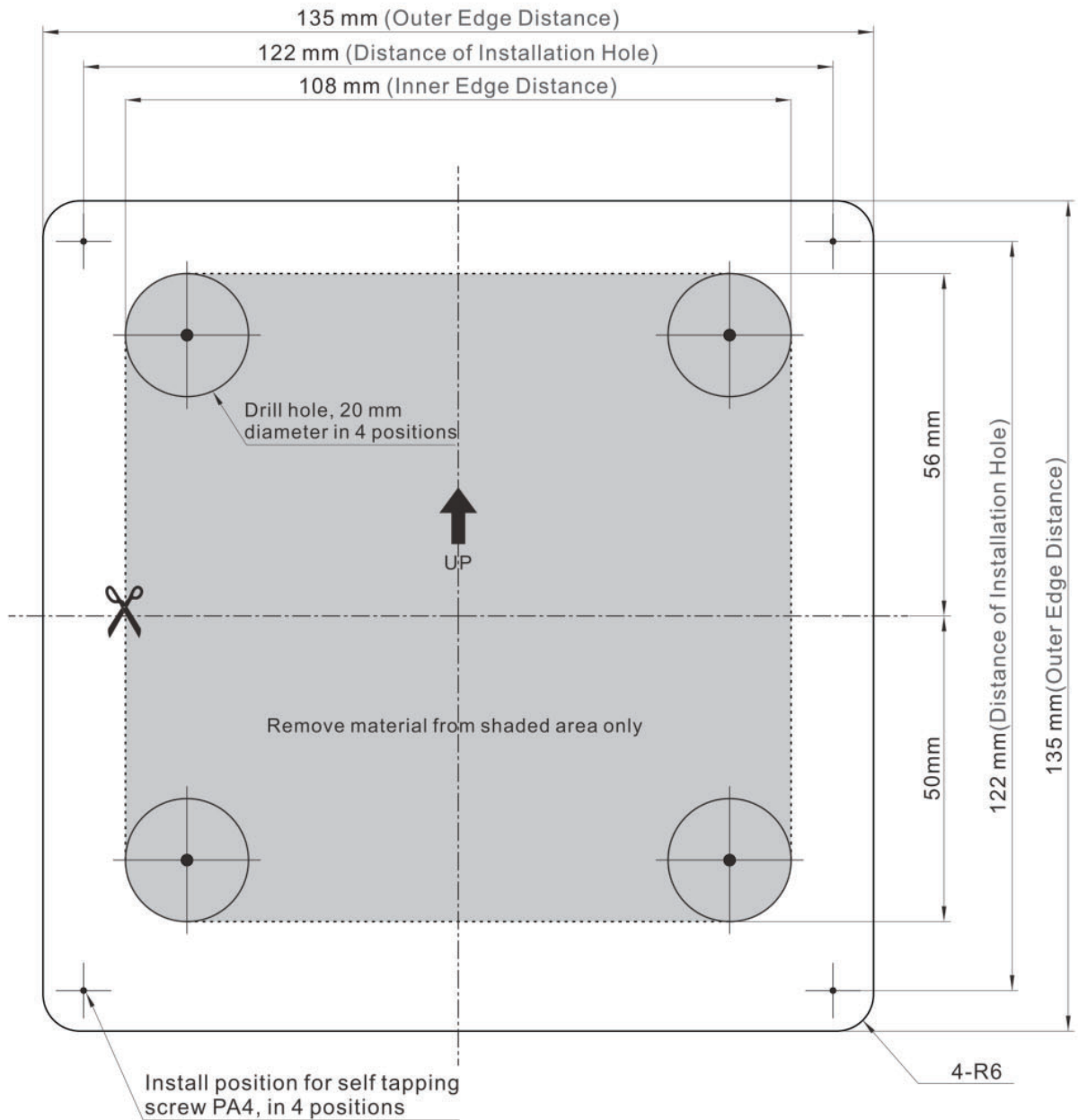

819ISP5020020

Declaration of Conformity

[FM-4850]

Bulgarian (BG)	С настоящото Furuno Electric Co., Ltd. декларира, че гореспоменат тип радиосъоръжение е в съответствие с Директива 2014/53/ЕС, СИ 2017/1206. Цялостният текст на ЕС/УК декларацията за съответствие може да се намери на следния интернет адрес:
Spanish (ES)	Por la presente, Furuno Electric Co., Ltd. declara que el tipo de equipo radioeléctrico arriba mencionado es conforme con la Directiva 2014/53/UE, SI 2017/1206. El texto completo de la declaración de conformidad de la EU/UK está disponible en la siguiente dirección Internet:
Czech (CS)	Tímto Furuno Electric Co., Ltd. prohlašuje, že výše zmíněné typ rádiového zařízení je v souladu se směrnicí 2014/53/EU, SI 2017/1206. Úplné znění EU/SK prohlášení o shodě je k dispozici na této internetové adrese:
Danish (DA)	Hermed erklærer Furuno Electric Co., Ltd., at ovennævnte radioudstyr er i overensstemmelse med direktiv 2014/53/EU, SI 2017/1206. EU/UK-overensstemmelseserklæringens fulde tekst kan findes på følgende internetadresse:
German (DE)	Hiermit erkläre die Furuno Electric Co., Ltd., dass der oben genannte Funkanlagentyp der Richtlinie 2014/53/EU, SI 2017/1206 entspricht. Der vollständige Text der EU/UK-Konformitätserklärung ist unter der folgenden Internetadresse verfügbar:
Estonian (ET)	Käesolevaga deklareerib Furuno Electric Co., Ltd., et ülalmainitud raadioseadme tüüp vastab direktiivi 2014/53/EL, SI 2017/1206 nõuetele. EL/GB vastavusdeklaratsiooni täielik tekst on kättesaadav järgmisel internetiaadressil:
Greek (EL)	Με την παρούσα η Furuno Electric Co., Ltd., δηλώνει ότι ο προαναφερθέντας ραδιοεξοπλισμός πληροί την οδηγία 2014/53/ΕΕ, SI 2017/1206. Το πλήρες κείμενο της δήλωσης συμμόρφωσης ΕΕ/UK διατίθεται στην ακόλουθη ιστοσελίδα στο διαδίκτυο:
English (EN)	Hereby, Furuno Electric Co., Ltd. declares that the above-mentioned radio equipment type is in compliance with Directive 2014/53/EU, SI 2017/1206. The full text of the EU/UK declaration of conformity is available at the following internet address:
French (FR)	Le soussigné, Furuno Electric Co., Ltd., déclare que l'équipement radioélectrique du type mentionné ci-dessus est conforme à la directive 2014/53/UE, SI 2017/1206. Le texte complet de la déclaration UE/RU de conformité est disponible à l'adresse internet suivante:
Croatian (HR)	Furuno Electric Co., Ltd. ovime izjavljuje da je gore rečeno radijska oprema tipa u skladu s Direktivom 2014/53/EU, SI 2017/1206. Cjeloviti tekst EU/UK izjave o sukladnosti dostupan je na sljedećoj internetskoj adresi:
Italian (IT)	Il fabbricante, Furuno Electric Co., Ltd., dichiara che il tipo di apparecchiatura radio menzionato sopra è conforme alla direttiva 2014/53/UE, SI 2017/1206. Il testo completo della dichiarazione di conformità UE/RU è disponibile al seguente indirizzo Internet:
Latvian (LV)	Ar šo Furuno Electric Co., Ltd. deklarē, ka augstāk minēts radioiekārta atbilst Direktīvai 2014/53/ES, SI 2017/1206. Pilns ES/AK atbilstības deklarācijas teksts ir pieejams šādā interneta vietnē:
Lithuanian (LT)	Aš, Furuno Electric Co., Ltd., patvirtinu, kad pirmiau minėta radijo įrenginių tipas atitinka Direktyvą 2014/53/ES, SI 2017/1206. Visas ES/JK atitikties deklaracijos tekstas prieinamas šiuo interneto adresu:
Hungarian (HU)	Furuno Electric Co., Ltd. igazolja, hogy fent említett típusú rádióberendezés megfelel a 2014/53/EU, SI 2017/1206 irányszabványnak. Az EU/EK-megfelelőségi nyilatkozat teljes szövege elérhető a következő internetes címen:
Maltese (MT)	B'dan, Furuno Electric Co., Ltd., niddikjara li msemmija hawn fuq-tip ta' tagħmir tar-radju huwa konformi mad-Direttiva 2014/53/UE, SI 2017/1206. It-test kollu tad-dikjarazzjoni ta' konformità tal-UE/RU huwa disponibbli f'dan l-indirizz tal-Internet li ġej:
Dutch (NL)	Hierbij verklaar ik, Furuno Electric Co., Ltd., dat het hierboven genoemde type radioapparatuur conform is met Richtlijn 2014/53/EU, SI 2017/1206. De volledige tekst van de EU/UK-conformiteitsverklaring kan worden geraadpleegd op het volgende internetadres:
Polish (PL)	Furuno Electric Co., Ltd. niniejszym oświadcza, że wyżej wymieniony typ urządzenia radiowego jest zgodny z dyrektywą 2014/53/UE, SI 2017/1206. Pełny tekst deklaracji zgodności UE/UK jest dostępny pod następującym adresem internetowym:
Portuguese (PT)	O(a) abaixo assinado(a) Furuno Electric Co., Ltd. declara que o mencionado acima tipo de equipamento de rádio está em conformidade com a Diretiva 2014/53/UE, SI 2017/1206. O texto integral da declaração de conformidade da EU/UK está disponível no seguinte endereço de Internet:
Romanian (RO)	Prin prezenta, Furuno Electric Co., Ltd. declară că echipamentul radio menționat mai sus este în conformitate cu Directiva 2014/53/UE, SI 2017/1206. Textul integral al declarației de conformitate UE/RU este disponibil la următoarea adresă internet:
Slovak (SK)	Furuno Electric Co., Ltd. týmto vyhlasuje, že vyššie spomínané rádiové zariadenie typu je v súlade so smernicou 2014/53/EÚ, SI 2017/1206. Úplné EÚ/SK vyhlásenie o zhode je k dispozícii na tejto internetovej adrese:
Slovenian (SL)	Furuno Electric Co., Ltd. potrjuje, da je zgoraj omenjeno tip radijske opreme skladen z Direktivo 2014/53/EU, SI 2017/1206. Celotno besedilo izjave EU/ZK o skladnosti je na voljo na naslednjem spletnem naslovu:
Finnish (FI)	Furuno Electric Co., Ltd. vakuuttaa, että yllä mainittu radiolaitetyyppi on direktiivin 2014/53/EU, SI 2017/1206 mukainen. EU/UK-vaatimustenmukaisuusvakuutuksen täysimittainen teksti on saatavilla seuraavassa internetosoitteessa:
Swedish (SV)	Härmed försäkrar Furuno Electric Co., Ltd. att ovan nämnda typ av radioutrustning överensstämmer med direktiv 2014/53/EU, SI 2017/1206. Den fullständiga texten till EU/Storbritannien-försäkran om överensstämmelse finns på följande webbadress:

Online Resource

http://www.furuno.com/en/support/red_doc

PSTI Statement of Compliance

We **FURUNO ELECTRIC CO., LTD.**

(Name of manufacturer of the product)

9-52 Ashihara-Cho, Nishinomiya City, 662-8580, Hyogo, Japan

(Address of manufacturer of the product)

declare under our sole responsibility that the product

**MARINE VHF RADIOTELEPHONE
FM-4800, FM-4850**

(Product type, batch)

December / 31 / 2028

(Support period for the product)

https://www.furuno.co.jp/en/csr/sociality/customer/product_security.html

(Weblink for latest information and contact to report to the manufacturer security issues)

to which this declaration relates conforms to the following standard(s) or other normative document(s)

Product Security and Telecommunications Infrastructure Act 2022

Product Security and Telecommunications Infrastructure (Security Requirements for
Relevant Connectable Products) Regulations 2023 Schedule 1

On behalf of Furuno Electric Co., Ltd.

Nishinomiya City, Japan
17 May 2024

(Place and date of issue)

Akihiko Kanechika
Department General Manager
Quality Assurance Department

(Signature, name and function of the signatory)

