

FURUNO

OPERATOR'S MANUAL

GPS/WAAS COLOR CHART PLOTTER *with FISH FINDER*

Model **GP-3700F**

(Product Name: GPS PLOTTER/SOUNDER)

Link For Operator's Manual and Guide

The Operator's Manual and Guide for this equipment can be viewed on our official website. You can also download it from the Quick Response Code on the right, or the URL below.



<https://www.furuno.com/en/support/manuals/terms>

 FURUNO ELECTRIC CO., LTD.



www.furuno.com

FURUNO ELECTRIC CO., LTD.

9-52 Ashihara-cho,
Nishinomiya, 662-8580, JAPAN

• FURUNO Authorized Distributor/Dealer

All rights reserved. Printed in Japan

Pub. No. OME-44920-J

(AIHA) GP-3700F

A : APR. 2017

J : DEC. 01, 2025



0 0 0 1 0 0 9 5 3 2 0

IMPORTANT NOTICES

General

- This manual has been authored with simplified grammar, to meet the needs of international users.
- The operator of this equipment must read and follow the instructions in this manual. Wrong operation or maintenance can void the warranty or cause injury.
- Do not copy any part of this manual without written permission from FURUNO.
- If this manual is lost or worn, contact your dealer about replacement.
- The contents of this manual and the equipment specifications can change without notice.
- The example screens (or illustrations) shown in this manual can be different from the screens you see on your display. The screens you see depend on your system configuration and equipment settings.
- Save this manual for future reference.
- Any modification of the equipment (including software) by persons not authorized by FURUNO will void the warranty.
- The following concern acts as our importer in Europe, as defined in DECISION No 768/2008/EC.
 - Name: FURUNO EUROPE B.V.
 - Address: Siriusstraat 86, 5015 BT, Tilburg, The Netherlands
- The following concern acts as our importer in UK, as defined in SI 2016/1025 as amended SI 2019/470.
 - Name: FURUNO (UK) LTD.
 - Address: West Building Penner Road Havant Hampshire PO9 1QY, U.K.
- All brand, product names, trademarks, registered trademarks, and service marks belong to their respective holders.

How to discard this product

Discard this product according to local regulations for the disposal of industrial waste. For disposal in the USA, see the homepage of the Electronics Industries Alliance (<http://www.eiae.org/>) for the correct method of disposal.

How to discard a used battery

Some FURUNO products have a battery(ies). To see if your product has a battery, see the chapter on Maintenance. Follow the instructions below if a battery is used. Tape the + and - terminals of battery before disposal to prevent fire, heat generation caused by short circuit.

In the European Union

The crossed-out trash can symbol indicates that all types of batteries must not be discarded in standard trash, or at a trash site. Take the used batteries to a battery collection site according to your national legislation and the Batteries Directive 2006/66/EU.

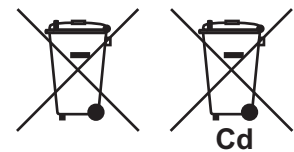

In the USA

The Mobius loop symbol (three chasing arrows) indicates that Ni-Cd and lead-acid rechargeable batteries must be recycled. Take the used batteries to a battery collection site according to local laws.

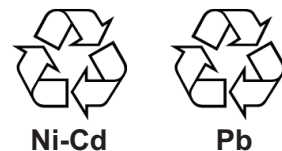

In the other countries

There are no international standards for the battery recycle symbol. The number of symbols can increase when the other countries make their own recycle symbols in the future.



SAFETY INSTRUCTIONS

The operator must read the safety instructions before attempting to operate the equipment.



WARNING

Indicates a potentially hazardous situation which, if not avoided, could result in death or serious injury.



CAUTION

Indicates a potentially hazardous situation which, if not avoided, could result in minor or moderate injury.



Warning, Caution



Prohibitive Action



Mandatory Action



WARNING



Do not open the equipment.

The equipment uses high voltage that can cause electrical shock. Refer any repair work to a qualified technician.



If water leaks into the equipment or something is dropped into the equipment, immediately turn off the power at the switchboard.

Fire or electrical shock can result.



If the equipment is giving off smoke or fire, immediately turn off the power at the switchboard.

Fire or electrical shock can result.



If you feel the equipment is acting abnormally or giving off strange noises, immediately turn off the power at the switchboard and contact a FURUNO service technician.



WARNING



Do not disassemble or modify the equipment.

Fire, electrical shock or serious injury can result.



Make sure no rain or water splash leaks into the equipment.

Fire or electrical shock can result if water leaks into the equipment.



Do not place liquid-filled containers on or near the equipment.

Fire or electrical shock can result if a liquid spills into the equipment.











Do not operate the equipment with wet hands.

Electrical shock can result.



Use the proper fuse.

Use of the wrong fuse can cause fire or electrical shock.

 CAUTION	 CAUTION
 Do not turn on the equipment with the transducer out of water. The transducer can be damaged.	 Do not depend on one navigation device for the navigation of the vessel. Always check your position against all available aids to navigation, for the safety of vessel and crew.
 The picture is not refreshed when picture advancement is stopped. Maneuvering the vessel in this condition can result in a dangerous situation.	 Do not disconnect the power cable while the system is powered. Damage to the equipment can result.
 Adjust the gain correctly. Incorrect gain can give a wrong depth indication, which could result in a dangerous situation.	 Do not bend cables in cold weather (0°C(32°F) or less). The cables will break.

About the TFT LCD

The TFT LCD is constructed using the latest LCD techniques, and displays 99.99% of its pixels. The remaining 0.01% of the pixels may drop out or blink, however this is not an indication of malfunction.

Warning Label

A warning label is attached to the display unit. Do not remove the label. If the label is missing or damaged, contact a FURUNO agent or dealer about replacement.



Name: Warning Label (1)
 Type: 86-003-1011-3

TABLE OF CONTENTS

FOREWORD	ix
SYSTEM CONFIGURATION	xi
1. OPERATIONAL OVERVIEW	1-1
1.1 Controls.....	1-1
1.1.1 Display unit.....	1-1
1.1.2 Trackball control unit RCU-030 (option).....	1-3
1.2 How to Turn the Power On/Off.....	1-3
1.3 How to Adjust the Brilliance of the Display and Panel	1-4
1.4 How to Select and Set a Display.....	1-5
1.4.1 How to select a display	1-5
1.4.2 How to change a display's setting.....	1-5
1.4.3 How to skip a display	1-7
1.4.4 How to set the navigation/destination information.....	1-8
1.4.5 How to switch the active screen.....	1-9
1.5 Menu Overview	1-9
1.6 MOB Operations	1-11
1.7 Function Keys	1-12
1.7.1 How to operate a function key.....	1-12
1.7.2 How to set up a function key.....	1-12
1.8 Demo Mode.....	1-14
1.9 How to Install Charts.....	1-15
2. PLOTTER DISPLAY OVERVIEW	2-1
2.1 Plotter Display	2-1
2.1.1 Plotter display layout.....	2-1
2.1.2 NAV information box	2-2
2.1.3 Compass display.....	2-3
2.1.4 Satellite status/location display	2-4
2.1.5 Tide graph display.....	2-5
2.2 How to Use the Cursor.....	2-6
2.3 How to Change the Chart Scale (Zoom In, Zoom Out).....	2-6
2.4 Orientation Mode.....	2-7
2.5 How to Shift the Display	2-8
2.6 How to Measure the Range and Bearing Between Two Points	2-9
2.7 How to Change the Cursor Configuration	2-10
2.8 Chart Icons.....	2-12
3. TRACK	3-1
3.1 How to Show/Hide Track.....	3-1
3.1.1 How to show/hide own ship track.....	3-1
3.1.2 How to show/hide other ship's tracks and symbols.....	3-4
3.1.3 How to show/hide the current vector.....	3-4
3.1.4 How to show/hide drift vector.....	3-5
3.2 How to Record Own Ship's Track	3-5
3.2.1 How to stop/restart recording of track	3-5
3.2.2 How to show track while track plotting is stopped.....	3-6
3.2.3 How to connect track after restarting plotting.....	3-6
3.3 How to Change Track Color.....	3-7
3.3.1 How to change track color for own ship	3-7
3.3.2 How to automatically change track color for own ship with water temperature.....	3-7

3.3.3	How to automatically change track color for own ship with depth	3-9
3.3.4	How to collectively change track color for other ship	3-10
3.3.5	How to separately change track color for TT symbol	3-10
3.4	How to Change Track Line Type	3-11
3.4.1	How to change track line type for own ship	3-11
3.4.2	How to collectively change track line type for other ship	3-11
3.4.3	How to separately change track line type for TT symbol	3-12
3.5	How to Select Track Plotting Method, Interval	3-12
3.5.1	How to select the track plotting method for own ship	3-12
3.5.2	How to set the track plotting intervals for own ship	3-12
3.5.3	How to set the track plotting intervals for other ship	3-13
3.6	How to Erase Own Ship Track	3-13
3.7	How to Edit Own Ship Track	3-15
3.8	How to Display Own Ship Information	3-16
3.8.1	Simple information	3-16
3.8.2	Detailed information	3-17
3.9	How to Display Other Ship Information	3-18
3.10	How to Change the Size of the Target Number	3-20
3.11	How to Erase Other Ship Track	3-21
4.	MARKS, LINES	4-1
4.1	How to Set Default Mark Appearance	4-1
4.1.1	How to set mark color	4-1
4.1.2	How to set mark size	4-2
4.1.3	How to set line type	4-2
4.1.4	How to set fish type for marks	4-3
4.2	How to Enter Marks	4-3
4.2.1	How to enter marks at own ship position	4-3
4.2.2	How to enter marks at the cursor position	4-4
4.2.3	How to enter marks by manually entering latitude and longitude position	4-4
4.3	How to Enter Lines	4-5
4.4	How to Erase Marks, Lines	4-6
4.5	How to Edit Marks, Lines	4-7
4.6	How to Undo or Redo Mark/Line Operation	4-9
4.7	How to Show Mark Information	4-9
4.8	How to Show Mark List	4-11
4.9	Mark Filter	4-15
4.10	How to Send Mark Data to Radar	4-18
5.	WAYPOINTS	5-1
5.1	How to Enter Waypoints	5-1
5.1.1	How to enter waypoints at own ship position	5-1
5.1.2	How to enter waypoints at the cursor position	5-1
5.1.3	How to enter waypoints by manually entering latitude and longitude position	5-2
5.1.4	How to enter waypoints by range and bearing	5-4
5.1.5	How to enter waypoints by Loran A or Loran C LOPs	5-5
5.1.6	How to enter waypoints by Decca LOPs	5-6
5.2	How to Edit Waypoints	5-7
5.3	How to Erase a Waypoint	5-8
5.4	How to Search Waypoints	5-8
5.5	How to Set Speed to Use in TTG Calculation	5-9
5.6	How to Display Waypoint Information	5-9
5.7	How to Change Waypoint Mark Size	5-10
5.8	How to Mark Radar Target Position	5-10

6. ROUTES	6-1
6.1 How to Create Routes.....	6-1
6.1.1 How to create routes with existing waypoints	6-1
6.1.2 How to create track-based routes using own ship position	6-3
6.1.3 How to create routes with selected tracks.....	6-4
6.2 How to Edit Routes	6-5
6.2.1 How to insert waypoints	6-5
6.2.2 How to delete waypoints from routes	6-6
6.3 How to Delete Routes	6-6
6.4 How to Search Routes	6-6
6.5 How to Set the Speed to Use in TTG Calculation	6-7
7. DESTINATION	7-1
7.1 How to Go to a Quick Point.....	7-1
7.2 How to Set a Waypoint as Destination.....	7-4
7.3 How to Follow Routes	7-6
7.4 How to Stop Navigation.....	7-8
8. ALARMS	8-1
8.1 How to Turn the Audio Alarm On/Off	8-2
8.2 Arrival, Anchor Watch Alarm	8-3
8.3 Route Alarm	8-4
8.4 XTE, Border Alarm	8-4
8.5 Intrusion Point Alarm.....	8-5
8.6 Ship Speed Alarm	8-5
8.7 Trip Range Alarm	8-6
8.8 Water Temperature Alarm.....	8-6
8.9 Shear Alarm	8-7
8.10 Depth Alarm	8-8
9. OTHER FUNCTIONS	9-1
9.1 [COAST LINE SETTING] Menu	9-1
9.1.1 [COAST LINE DETAIL SETTING] menu.....	9-1
9.1.2 How to display depth contour in detail	9-4
9.2 [PLOTTER DISPLAY SETTING] Menu	9-6
9.2.1 How to set TD display	9-6
9.2.2 How to set range for plotter display.....	9-9
9.3 [DISPLAY FORMAT] Menu.....	9-9
9.4 [NAVIGATOR SETUP] Menu	9-16
9.5 [INPUT/OUTPUT PORT SETTING] Menu	9-19
9.5.1 How to set the output 1, 2 or 3	9-19
9.5.2 How to set the Ethernet.....	9-21
9.5.3 How to set the FA-30	9-22
9.5.4 How to display the information for NMEA2000 equipment.....	9-23
9.5.5 How to set the NMEA2000 PGN.....	9-23
9.6 [TEST & MEMORY CLEAR] Menu	9-24
9.6.1 How to set or change the password.....	9-24
9.6.2 How to disable the password	9-25
9.6.3 How to set the trackball sensitivity	9-25
9.7 LINE MONITOR	9-26
10. HOW TO RECORD, PLAY BACK DATA	10-1
10.1 Data Recording	10-1
10.2 Internal Memory	10-1
10.2.1 How to save the data to the internal memory.....	10-1
10.2.2 How to display the data stored in the internal memory	10-3

10.2.3	How to play back data from the internal memory	10-4
10.2.4	How to delete data from the internal memory	10-5
10.3	USB Flash Memory Operations.....	10-5
10.3.1	How to insert a USB flash memory	10-5
10.3.2	How to safely remove a USB flash memory.....	10-6
10.3.3	How to save the data to a USB flash memory.....	10-6
10.3.4	How to play back the data from the USB flash memory.....	10-7
10.3.5	How to transfer the data from the USB flash memory.....	10-8
10.4	Backup Data.....	10-9
10.4.1	How to backup the data automatically.....	10-9
10.4.2	How to backup the data manually	10-10
10.4.3	How to load the backup data.....	10-11
10.5	Screenshot (Screen Capture).....	10-12
10.6	How to Automatically Save NMEA 0183 Sentences (Data Logger).....	10-13
10.7	How to Load the Data from Other Equipment	10-14
11.	ECHO SOUNDER.....	11-1
11.1	How the Echo Sounder Operates.....	11-1
11.2	Echo Sounder Displays	11-1
11.2.1	Single frequency display (50 kHz or 200 kHz)	11-2
11.2.2	Dual frequency display	11-3
11.2.3	Marker zoom display (50 kHz or 200 kHz)	11-3
11.2.4	Bottom zoom display (50 kHz or 200 kHz).....	11-4
11.2.5	Bottom lock display (50 kHz or 200 kHz)	11-4
11.2.6	Bottom discrimination display (50 kHz or 200 kHz).....	11-5
11.2.7	A-scope display (50 kHz, 200 kHz or dual frequency)	11-5
11.2.8	Mix display.....	11-6
11.2.9	Plotter/echo sounder display	11-7
11.3	Automatic Echo Sounder Operation.....	11-8
11.3.1	How to select an automatic echo sounder mode	11-8
11.3.2	How to offset the base range or the gain	11-8
11.4	Manual Echo Sounder Operation	11-9
11.4.1	How to activate the manual echo sounder mode	11-9
11.4.2	How to select the display range	11-10
11.4.3	How to shift the display range	11-10
11.4.4	How to adjust the gain.....	11-11
11.5	How to Measure Depth, Time Between Locations	11-12
11.6	How to Enter a Mark on the Display.....	11-13
11.7	How to Reduce Interference.....	11-13
11.8	How to Reduce Low Level Noise.....	11-14
11.9	How to Erase Weak Echoes.....	11-14
11.10	How to Highlight Echoes in White Color	11-15
11.10.1	White marker	11-15
11.10.2	White line.....	11-16
11.11	Display Colors.....	11-16
11.12	How to Customize Display Colors.....	11-17
11.13	Picture Advance Speed	11-18
11.14	How to Review Past Picture	11-18
11.14.1	How to set up to display past picture.....	11-18
11.14.2	How to review past picture	11-19
11.15	ACCU-FISH™	11-20
11.15.1	How to set up ACCU-FISH™	11-20
11.15.2	How to correct measured fish size	11-21
11.15.3	How to select the display mode to show fish information.....	11-21
11.15.4	How to select the unit for fish length	11-22
11.16	Bottom Discrimination Display	11-22

TABLE OF CONTENTS

11.17	Alarms	11-24
11.17.1	Fish alarm (normal)	11-24
11.17.2	Fish alarm (bottom lock).....	11-25
11.17.3	Fish alarm (fish size).....	11-26
11.17.4	Bottom discrimination alarm.....	11-26
11.18	[ECHO SOUNDER SYSTEM SETTING] Menu.....	11-27
11.19	Zero Line Rejection	11-28
11.20	Echo Sounder Range Setting Menu.....	11-29
11.21	Interpreting the Display.....	11-30
12.	AIS OPERATIONS	12-1
12.1	AIS Symbols.....	12-1
12.2	How to Activate/Sleep Targets.....	12-2
12.3	AIS Tracks.....	12-3
12.3.1	How to show/hide AIS tracks	12-3
12.3.2	How to change the AIS symbol/track color or track line type.....	12-3
12.3.3	How to stop/restart recording of AIS track	12-3
12.4	AIS Target Data	12-4
12.4.1	How to display the individual AIS target data.....	12-4
12.4.2	How to display the AIS list.....	12-5
12.5	AIS Alarm	12-6
12.5.1	How to automatically activate targets.....	12-6
12.5.2	How to activate the AIS proximity alarm	12-6
12.5.3	How to set the CPA/TCPA alarm	12-7
12.5.4	How to set the lost alarm.....	12-7
12.5.5	How to set the external AIS alarm.....	12-8
13.	MAINTENANCE, TROUBLESHOOTING.....	13-1
13.1	Maintenance.....	13-1
13.2	Replacement of Fuse	13-2
13.3	Consumable Parts.....	13-2
13.4	Trackball Maintenance	13-2
13.5	Troubleshooting	13-3
13.6	Unit Information.....	13-5
13.7	Operation/Alarm Log	13-6
13.8	Diagnostics.....	13-7
13.8.1	Memory I/O test.....	13-7
13.8.2	Keyboard test.....	13-8
13.8.3	Test pattern	13-9
13.9	How to Clear the Memory	13-9
13.9.1	How to restore the settings	13-9
13.9.2	How to delete all screenshot data	13-10
13.9.3	How to delete user data	13-10
APPX. 1	MENU TREE	AP-1
APPX. 2	ICONS	AP-12
APPX. 3	TIME DIFFERENCES	AP-13
APPX. 4	WHAT IS SBAS/QZSS(SLAC)/DC REPORT?.....	AP-14
APPX. 5	ALARM LIST.....	AP-17
SPECIFICATIONS	SP-1	
INDEX.....	IN-1	

FOREWORD

Congratulation on your choice of the FURUNO GPS PLOTTER/SOUNDER GP-3700F. We are confident you will see why the FURUNO name has become synonymous with quality and reliability.

Since 1948, FURUNO Electric Company has enjoyed an enviable reputation for innovative and dependable marine electronics equipment. This dedication to excellence is furthered by our extensive global network of agents and dealers.

The equipment is designed and constructed to meet the rigorous demands of the marine environment. However, no machine can perform its intended function unless installed, operated and maintained properly. Please carefully read and follow the recommended procedures for operation and maintenance.

Features

The GP-3700F is a fully integrated GPS receiver, color video plotter, and color video fish finder. The system consists of a display unit, antenna unit, and transducer.

The main features of the GP-3700F are as follows:

- Combination displays (plotter, navigation data, compass, echo sounder) in various split screen configurations.
- Easily sort and display marks according to the sort conditions.
- Simple drift calculation provides a graphic presentation of surface water flow.
- Alarms: Arrival, anchor watch, XTE, border, speed, trip, AIS, CPA/TCPA, temperature, shear, depth, fish, fish size, bottom discrimination.
- Capture function records the fish finder screenshot in conjunction with marks.
- Fish finder picture scrollbar to view past echoes.
- Display AIS targets and TT targets.
- Undo and Redo functions.
- Bottom discrimination (bottom composition evaluator), ACCU-FISH™ (fish size estimator).

Software used in this product

This equipment uses the following open source software.

- Ubiquitous QuickBoot™ Copyright© Ubiquitous AI Corporation. All rights reserved.
- Portions of this software are copyright© 2016 The Free Type Project (www.freetype.org). All rights reserved.
- This product includes software to be licensed under the GNU General Public License (GPL) version 2.0, GNU Lesser General Public Software License (LGPL) version 2.0 and others. The program(s) is/are free software(s), and you can copy it and/or redistribute it and/or modify it under the terms of the GPL version 2.0 or LGPL version 2.0 as published by the Free Software Foundation. Please access to the following URL if you need source codes: https://www.furuno.co.jp/en/contact/cnt_oss_e01.html.

FOREWORD

- This product includes software to be licensed under the Apache-2.0 and others. Please access the following URL for further information: <https://www.apache.org/licenses/LICENSE-2.0>
- This product includes software to be licensed under the BSD license and others. Please access the following URL for further information: <https://opensource.org/license/BSD-3-Clause>
- This product includes software to be licensed under MIT and others. Please access the following URL for further information: <https://opensource.org/license/MIT>
- This product includes software to be licensed under Amazon Software License and others. The Amazon Software License is limited to use with Amazon Web Service (AWS) related services. Please access the following URL for further information: <https://aws.amazon.com/asl/>

Interference relief measures

When another ship says it is receiving interference from your fish finder, change its working frequency or lower the transmission sound pressure level for the following equipment in the order shown.

- 1) Wideband fish finder
- 2) Fish finder with multiple frequencies
- 3) Fish finder with single frequency

Program No.

1451468-05.**

** denotes minor modifications.

CE/UKCA declaration

With regards to CE/UKCA declarations, please refer to our website (www.furuno.com), for further information about RoHS conformity declarations.

Disclosure of Information about China RoHS

With regards to China RoHS information for our products, please refer to our website (www.furuno.com).

SYSTEM CONFIGURATION

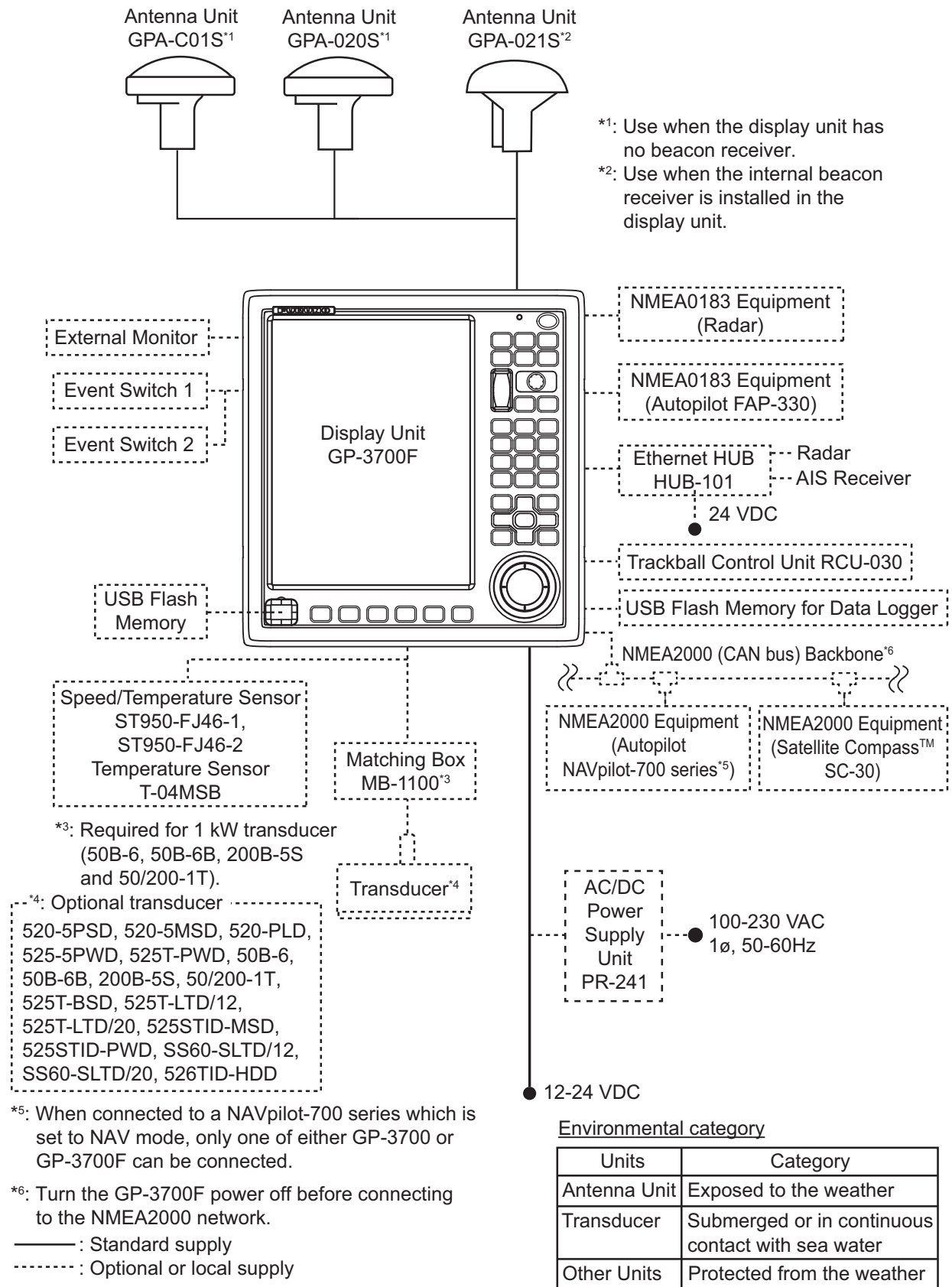

This page is intentionally left blank.

1. OPERATIONAL OVERVIEW



1.1 Controls

1.1.1 Display unit

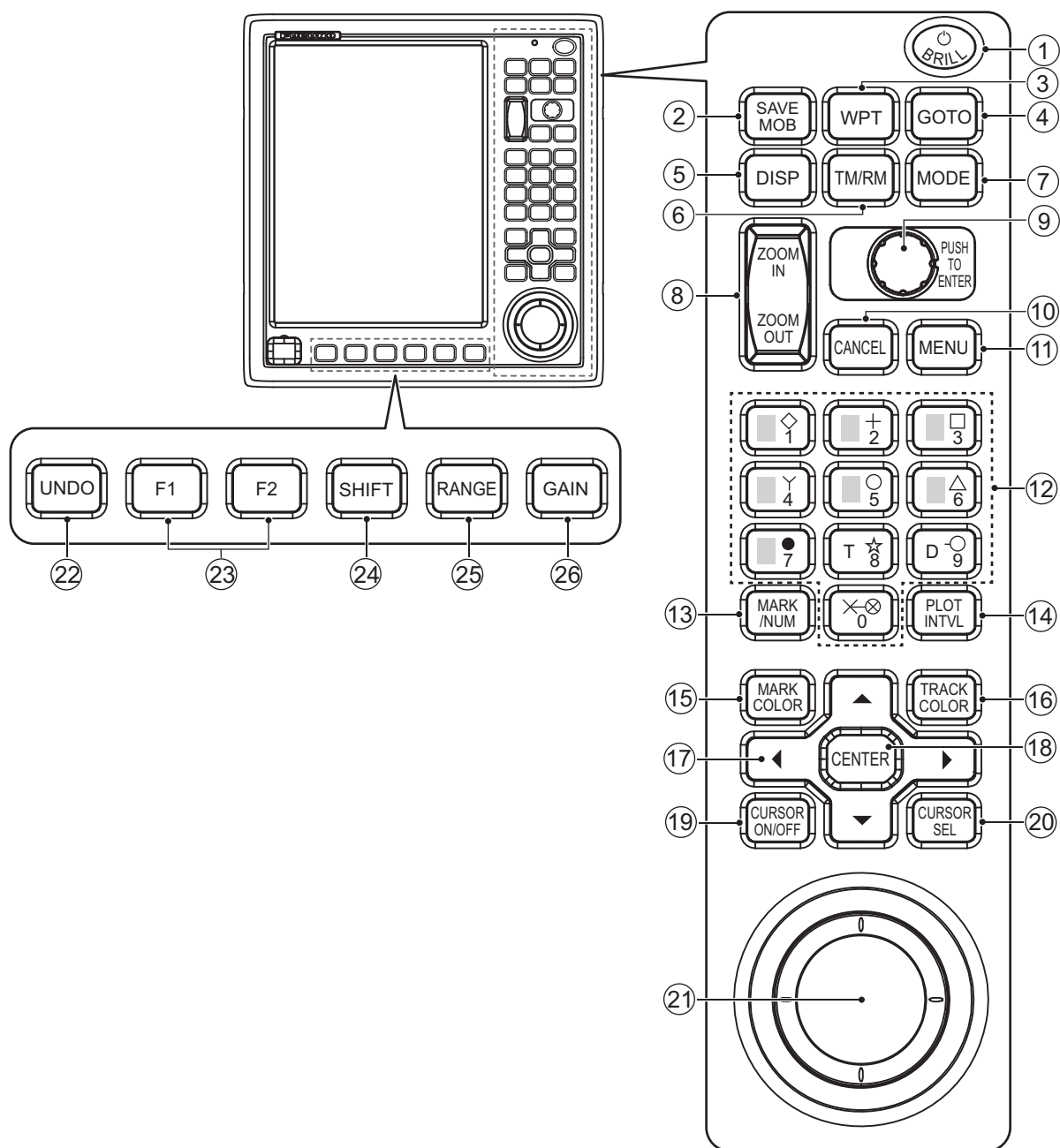
When you correctly execute an operation, the display unit generates a beep. Invalid operation causes the unit to emit two beeps. If you do not need the key beep, deactivate the beep sound (see section 9.3).



1. OPERATIONAL OVERVIEW

No.	Key, control	Description
1	 POWER/BRILL	<ul style="list-style-type: none"> • Short press at power-off: Turns the power on. • Short press at power-on: Opens the [BRILL] window. • Long press while powered: Turns the power off.
2	MOB	Marks a man overboard position at own ship position or cursor position.
3	WPT	Opens the [WAYPOINTS LIST] window.
4	GOTO	Sets, releases destination.
5	DISP	<ul style="list-style-type: none"> • Cycles through displays (basic screen: plotter, echo sounder). • Returns to the basic screen with menu or window open.
6	TM/RM	<p>Alternately selects true motion (TM) and relative motion (RM) displays.</p> <p>TM: The own ship mark moves along with own ship position.</p> <p>RM: The chart moves along with own ship position. The relative position for own ship mark on the screen is fixed.</p>
7	MODE	Changes the orientation mode.
8	ZOOM IN, ZOOM OUT	Zooms the chart display range in or out.
9	ENTER knob	<ul style="list-style-type: none"> • Rotate: Changes numeric data, selects menu items. • Push: Confirms alphanumeric data entry or an operation. • Push (default setting): Shows the past picture on the echo sounder display with the single frequency.
10	CANCEL	<ul style="list-style-type: none"> • Silences the audio alarm. • Erases marks and waypoints. • Clears alphanumeric data.
11	MENU	<ul style="list-style-type: none"> • Opens/closes the main menu. • With the menu open, goes back one layer in selected menu. • Closes the window.
12	Numeric keys 0 to 9	<ul style="list-style-type: none"> • Enters numeric data. • 1 to 8: Enters corresponding mark labeled on the key. • Selects menu items. • 0: Measures range and bearing between two points. • 9: Enters the same mark as the last entered one then connects them. This function is not available when no mark is entered since power-on.
13	MARK/NUM	Selects mark input format, mark symbol or numeric.
14	PLOT INTVL	Starts, stops plotting of own ship track.
15	MARK COLOR	Opens the [CHANGE MARK COLOR] window.
16	TRACK COLOR	Opens the [CHANGE TRACK COLOR] window.
17	 (CursorPad)	<ul style="list-style-type: none"> • Moves the cursor. • Selects menu items.
18	CENTER	<ul style="list-style-type: none"> • Cursor shown: Moves cursor to the screen center. • Cursor not shown: Moves own ship position to the screen center or the position one-third from the bottom of the screen depending on the orientation mode. • Confirms alphanumeric data entry or an operation on the menu.
19	CURSOR ON/OFF	<ul style="list-style-type: none"> • Turns on/off the cursor. • Switches + to - and vice versa. • Switches N to S, E to W and vice versa. • Long press: Switches control between split screen displays other than compass display.
20	CURSOR SEL	Selects cursor configuration among circle, parallel or diamond.
21	Trackball	Moves the cursor.
22	UNDO	Undoes previous mark/line input, edit or deletion operation.
23	F1, F2	Activates assigned program.

No.	Key, control	Description
24	SHIFT	<ul style="list-style-type: none"> • Opens the [FISH FINDER SHIFT] window (in manual echo sounder display). • Executes assigned program.
25	RANGE	<ul style="list-style-type: none"> • Opens the [BTM DISP RNG U (or L)/LIM] window (in automatic echo sounder display) or the [FISH FINDER RANGE] window (in manual echo sounder display). • Executes assigned program.
26	GAIN	<ul style="list-style-type: none"> • Opens the [AUTO GAIN OFFSET (HF) (or LF)] window (in automatic echo sounder display) or the [FISH FINDER GAIN (HF) (or LF)] window (in manual echo sounder display). • Executes assigned program.

1.1.2 Trackball control unit RCU-030 (option)

The optional trackball control unit RCU-030 can be used to control most features of this equipment.

No.	Description
1	Trackball: Moves the cursor.
2	Left button: Confirms alphanumeric data entry or an operation.
3	Scrollwheel: <ul style="list-style-type: none"> • Rotate upward: Zooms in the chart display range. • Rotate downward: Zooms out the chart display range. • Push with cursor shown: Moves cursor to the screen center in the plotter display. • Push with cursor not shown: Moves own ship position to the screen center or the position one-third from the bottom of the screen depending on the orientation mode in the plotter display.
4	Right button: <ul style="list-style-type: none"> • Displays/erases the cursor. • Switches + to - and vice versa. • Switches N to S, E to W and vice versa. • Long press: Switches control between split screen displays other than compass display.

1.2 How to Turn the Power On/Off

Note: Turn the NMEA2000 network power on before turning the GP-3700F power on.

Press the **POWER/BRILL** key at the top corner of the display unit to turn on the power. The unit then starts up in the sequence shown below.

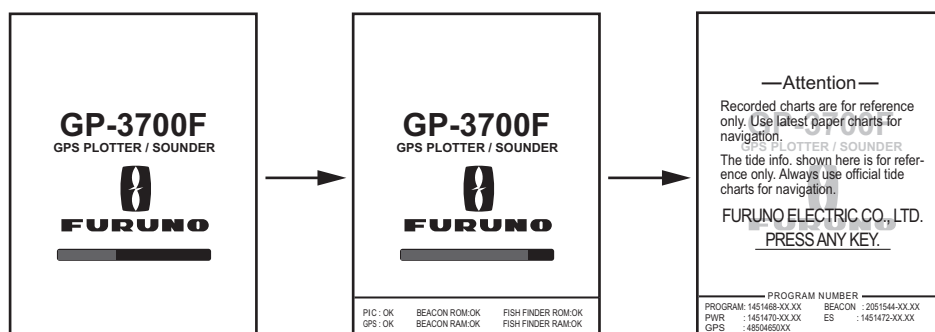

XX: Program version number

1. OPERATIONAL OVERVIEW

The start-up screen disappears then the last-used screen (e.g. plotter display) appears.

Your position is displayed approx. 90 seconds after the power on. Until your position is found, the message "NO FIX" is displayed at the bottom of the plotter display. After your position is found, the indication "2D" or "3D" appears depending on the position fix status.

Indication	Meaning	Indication	Meaning
GP-2D	2D GPS position fix	GP-S2D	2D GPS+SBAS position fix
GP-3D	3D GPS position fix	GP-S3D	3D GPS+SBAS position fix
GP-D2D	2D DGPS position fix	GP-Q2D	2D QZSS position fix
GP-D3D	3D DGPS position fix	GP-Q3D	3D QZSS position fix
NO FIX	No position fix		

To turn off the power, press and hold the **POWER/BRILL** key. The message "HOLDING THE POWER KEY WILL TURN THE GP-3700 OFF. POWER OFF IN 3 s." appears then the countdown until power-off is started. Press and hold the **POWER/BRILL** key until the indication "0 s" appears. The message "GP-3700 SHUTTING DOWN. PLEASE WAIT." appears then the power is turned off.

Note: Use the **POWER/BRILL** key to turn off the power. Also, turn off the main power after the display goes blank. If the unit is turned off from the main power, the settings and date from the 10 seconds before turning off the power may not be saved.

DGPS beacon receiver

The GP-3700F is available in two specifications, with DGPS beacon receiver and no DGPS beacon receiver. Only the beacon receiver equipped GP-3700F has DGPS capability. To get DGPS capability, install the optional internal DGPS beacon receiver (name: Beacon Receiver Set, type: OP14-80).

1.3 How to Adjust the Brilliance of the Display and Panel

The brilliance of the display and panel dimmer can be adjusted from the [BRILL] window.

1. Press the **POWER/BRILL** key to show the [BRILL] window.

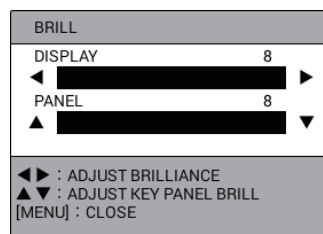

Note: The [BRILL] window closes automatically when there is no operation for five seconds.

2. To adjust the display brilliance, press ◀ or ▶, or rotate the **ENTER** knob (setting range: 1 to 8).
3. To adjust the panel brilliance, press ▲ or ▼, or push the **ENTER** knob (setting range: 1 to 8).

4. Press the **MENU** key to close the window.

Note: The brilliance of an external monitor cannot be adjusted from the display unit. Adjust it from the external monitor.

1.4 How to Select and Set a Display

There are two base screens; plotter and echo sounder. You can display combination data with these two modes. See chapter 2 for plotter, chapter 11 for echo sounder.

1.4.1 How to select a display

Press the **DISP** key consecutively to cycle through all the active displays. Displays other than display 1 can be skipped. See section 1.4.3.

1.4.2 How to change a display's setting

Five basic screens are pre-prepared. You can change the configuration of each screen to meet your operational needs, as shown in the procedure below. For menu operation, see section 1.5.

1. Press the **MENU** key to open the main menu.
2. Select [0. SYSTEM SETTING].

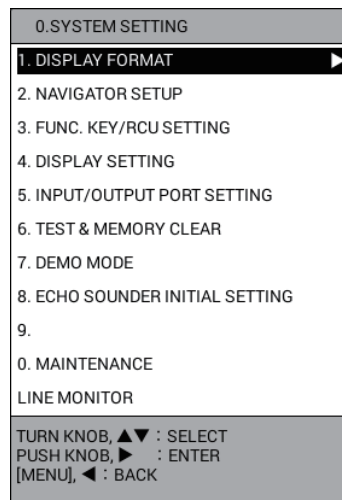

3. Select [4. DISPLAY SETTING].

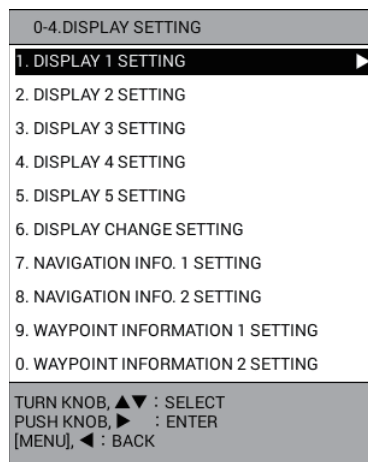

1. OPERATIONAL OVERVIEW

4. Select [1. DISPLAY 1 SETTING].

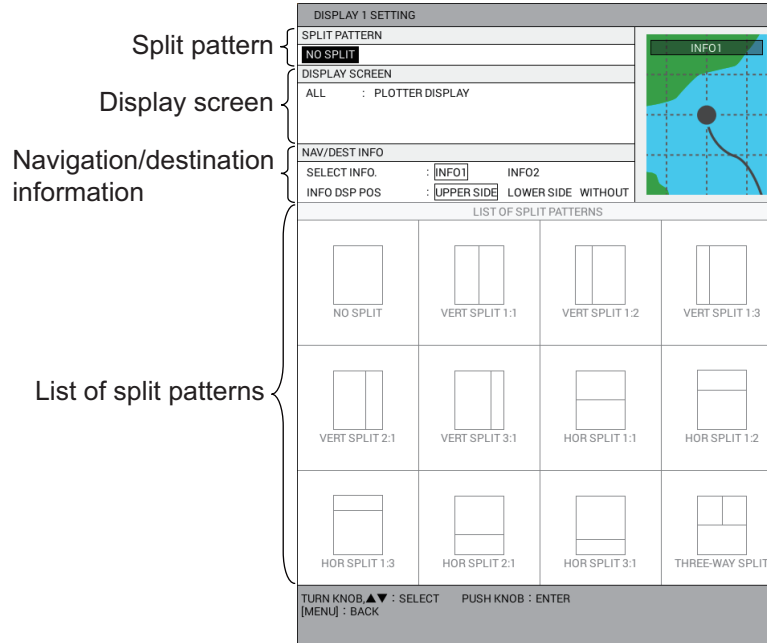

5. Select [SPLIT PATTERN].

6. Select the split pattern from [LIST OF SPLIT PATTERNS]. The following steps are for [VERT SPLIT 1:1] (vertical split 1:1).

7. Select [LEFT] in [DISPLAY SCREEN].



Note: The items in the list differ according to the split pattern selected at step 6.

8. Select the display screen from [LIST OF DISPLAY SCREENS].

Note: The plotter or compass can be selected as the upper display screen only in the horizontal split screen configuration ([HOR SPLIT 1:1]).

9. Set the right display screen in the same manner.

10. Select [SELECT INFO.] in [NAV/DEST INFO].

11. Select [INFO1] or [INFO2] to display nav data in the NAV information box (see section 2.1.1, section 2.1.2). You can select the data to show with destination set and with no destination set (see section 1.4.4).

	No destination set	With destination set
[INFO1]	Display the data set in the [NAVIGATION INFO. 1 SETTING] menu.	Display the data set in the [WAYPOINT INFORMATION 1 SETTING] menu.
[INFO2]	Display the data set in the [NAVIGATION INFO. 2 SETTING] menu.	Display the data set in the [WAYPOINT INFORMATION 2 SETTING] menu.

12. Select [INFO DSP POS] in [NAV/DEST INFO].
13. Select [UPPER SIDE] to display the navigation/destination information at the top of the screen, [LOWER SIDE] at the bottom of the screen. [WITHOUT] displays no navigation/destination information.
14. Set the displays 2 to 5 in the same manner.
15. Press the **DISP** key to close the menu.

1.4.3 How to skip a display

You may not require all five display screens. You can skip unnecessary ones as follows.

1. Press the **MENU** key to open the main menu.
2. Select [0. SYSTEM SETTING].
3. Select [4. DISPLAY SETTING].
4. Select [6. DISPLAY CHANGE SETTING].

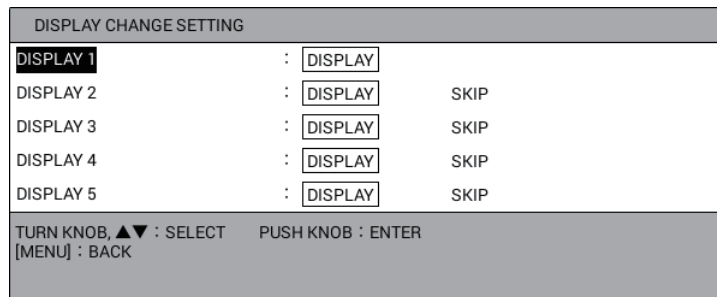

5. Select [DISPLAY 2] (or 3, 4, 5).
6. Select [DISPLAY] or [SKIP]. The displays which are set to [SKIP] are skipped when pressing the **DISP** key.
Note: The display 1 can not be skipped.
7. Press the **DISP** key to close the menu.

1. OPERATIONAL OVERVIEW

1.4.4 How to set the navigation/destination information

To set the navigation/destination information, do the following:

1. Press the **MENU** key to open the main menu.
2. Select [0. SYSTEM SETTING].
3. Select [4. DISPLAY SETTING].
4. Select [7. NAVIGATION INFO. 1 SETTING], [8. NAVIGATION INFO. 2 SETTING], [9. WAYPOINT INFORMATION 1 SETTING] or [0. WAYPOINT INFORMATION 2 SETTING].

When selecting [WAYPOINT INFORMATION 1 (or 2) SETTING], [WAYPOINT INFORMATION 1 (or 2) SETTING] and [DEST INFO1 (or 2)] are displayed.

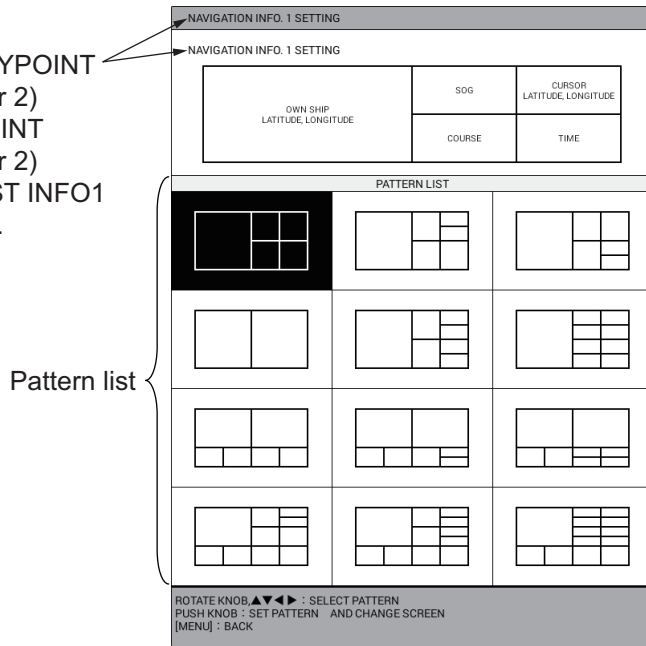

5. Select the layout for the NAV information box from the pattern list.
6. Select a frame, then select the item to display in the frame from the navigation data list. The items in the list differ according to the frame selected. To leave a frame blank, select [UNASSIGNED].

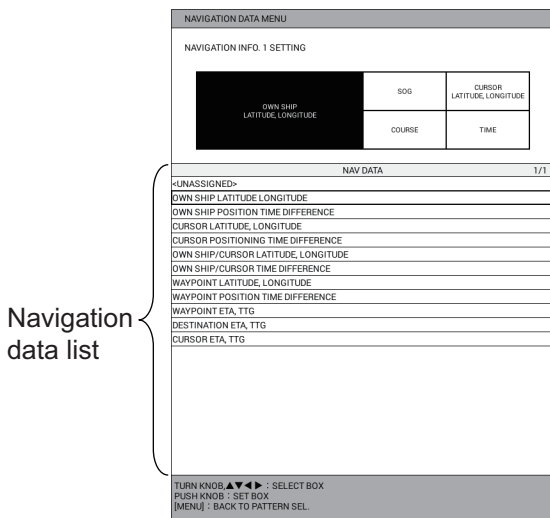

Ex. 1: When selecting the frame for [OWN SHIP LATITUDE LONGITUDE]

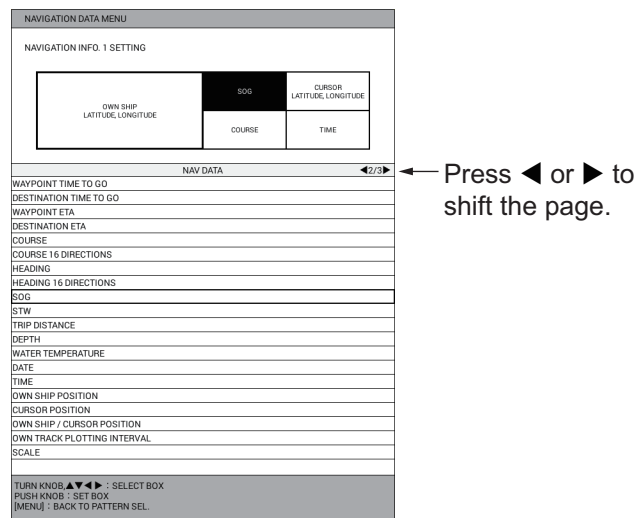

Ex. 2: When selecting the frame for [SOG]

7. Press the **DISP** key to close the menu.

1.4.5 How to switch the active screen

In the split screen for plotter or echo sounder, you can switch the active screen with the **CURSOR ON/OFF** key. Long-press the key to select the screen to make active. The active screen is circumscribed with an orange rectangle. The orange frame flashes three times then goes off. The icon  is displayed at the left top of the active screen.

Note: The icon  is displayed on the non-split screen. However, the icon can be difficult to see when the NAV information box is displayed at the top of the screen and the value for the transparency of the NAV information box is low.

1.5 Menu Overview

Main menu

1. Press the **MENU** key to open the main menu.

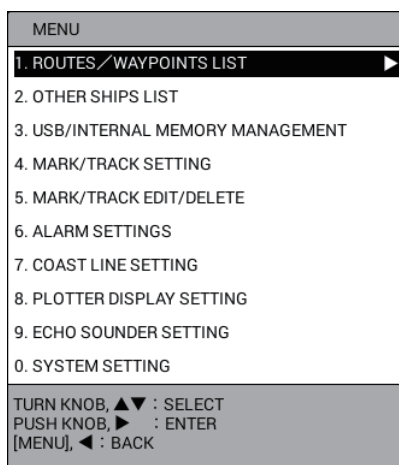

2. Rotate the **ENTER** knob to select a menu item, then push the knob to confirm your selection. Counterclockwise rotation moves the cursor downward or leftward; clockwise rotation moves the cursor upward or rightward. Selection can also be confirmed by pressing the **CENTER** key. Menus can also be selected by pressing the numeric key corresponding to the menu item number.

Note: The procedures in this manual, for sake of brevity, replace the “rotate” and “push” actions with “select”. For example, we write “Select [0. SYSTEM SETTING]” in place of “Rotate the **ENTER** knob to select the [0. SYSTEM SETTING] menu, then push the knob to confirm your selection”.

A menu that shows a right arrow (►) indicates additional sub menus.

3. If the menu has additional sub menus, repeat step 2 to select menu items on the sub menus. To go back one layer, press the **MENU** key or ◀.
4. Select required menu option, like in step 2.
5. Press the **DISP** key to close the menu.

1. OPERATIONAL OVERVIEW

How to enter alphanumeric data

The character entry window appears when you are required to enter alphanumeric data. Press the **CURSOR ON/OFF** key to switch alphabet between upper case and lower case.

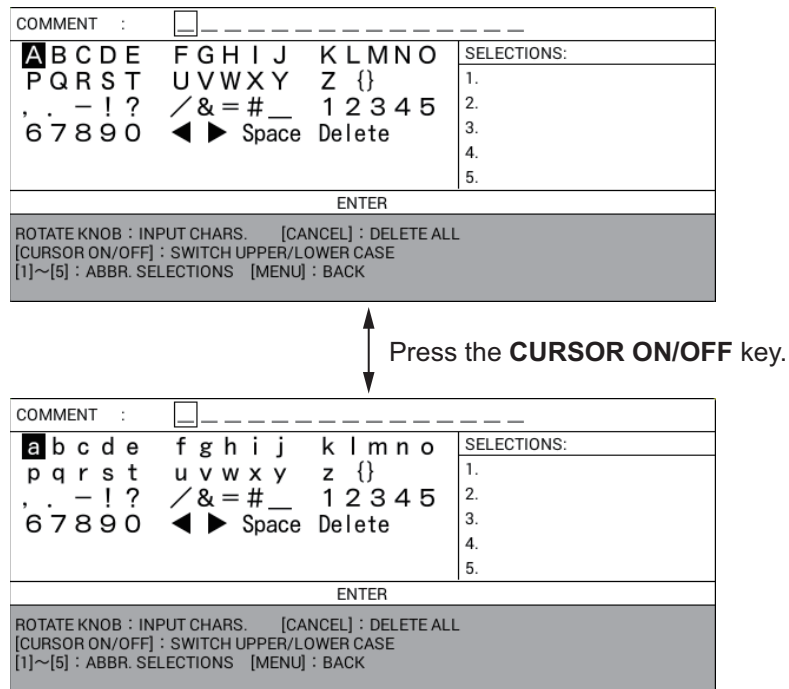

1. Rotate the **ENTER** knob or the trackball to select character then push the knob to confirm selection. Alternatively, you can use the Cursorpad to select a character then press the **CENTER** key to confirm selection.
2. Repeat step 1 to select all other characters.
Delete a character: Select ◀ or ▶ to move the data input cursor to the character deleted then select [Delete].
Suggest feature: This unit remembers five of the most frequently input character strings, and shows them in the [SELECTIONS] window. To select one, press the corresponding numeric key (1 to 5).
3. Select [ENTER] then push the **ENTER** knob.

How to enter numeric data

Do one of the following:

- Press applicable numeric key.
- Rotate the **ENTER** knob to select numeric, then push the knob to confirm.

Unless noted otherwise, this manual uses the “numeric key” method.

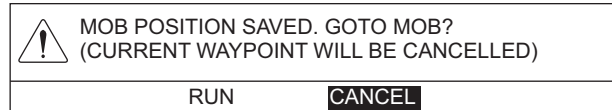

1.6 MOB Operations

The MOB (Man OverBoard) mark denotes man overboard position. Press the **SAVE MOB** key to inscribe this mark should someone fall overboard. The following message appears.



Select [RUN] to set the MOB mark position as the destination.

You can inscribe a MOB mark at the own ship position or the cursor position (see page 9-15).

MOB mark	Mark position
	The mark is put at the own ship position at the moment you press the SAVE MOB key.
	The mark is put at the position selected with the cursor.

A light-blue line runs between the MOB position and own ship. This line is the shortest course from the current position to the MOB position. The arrows on the line point in the direction of course flow. The range and bearing from the own ship position to the MOB position are displayed at the left top of the screen.

Only one MOB mark can be put on the plotter display, and each time the **SAVE MOB** key is operated the previous MOB mark and its position data are written over.

How to delete a MOB mark

1. Press the **CURSOR ON/OFF** key to turn on the cursor.
2. Use the trackball to put the cursor on the MOB mark.
3. Press the **CANCEL** key. The following message appears.

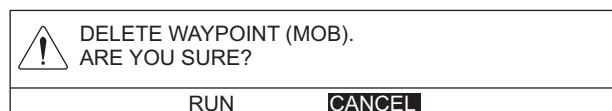

4. Select [RUN] to delete the MOB mark.

1.7 Function Keys

Some menu functions and menus can be assigned to the **F1** or **F2** key. This allows one-touch access to the assigned function or menu. The **SHIFT**, **RANGE** and **GAIN** keys can be available for function keys.

Note: The **F1** (or **F2**) key programmed with an echo sounder function is valid only on the echo sounder display or the echo sounder menu.

1.7.1 How to operate a function key

Press the function key that corresponds to the function you want to use.

1.7.2 How to set up a function key

You can change the function assigned to a function key.

1. Press the **MENU** key to open the main menu.
2. Select [0. SYSTEM SETTING].
3. Select [3. FUNC. KEY/RCU SETTING].

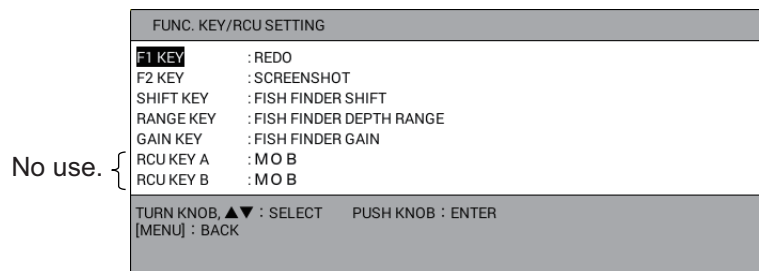

4. Select the item to change. For example, select [F1 KEY] when you change the function assigned to the **F1** key.
5. Referring to the table below, select a function.

Function	Description
[WAYPOINT LIST]	Opens [WAYPOINTS LIST].
[ROUTES LIST]	Opens [ROUTES LIST].
[SAVE USB MEMORY]	Opens the [USB MEMORY RECORDING] menu.
[READ USB MEMORY]	Opens the [USB MEMORY PLAYBACK] menu.
[INTERNAL MEMORY RECORDING]	Opens the [INTERNAL MEMORY RECORDING] menu.
[INTERNAL MEMORY PLAYBACK]	Opens the [INTERNAL MEMORY PLAYBACK] menu.
[TRF USB TO INT MEMORY]	Opens the [TRF USB TO INT MEMORY] menu.
[DISPLAY INTERNAL MEMORY]	Opens the [DISPLAY INTERNAL MEMORY] menu.
[MARK LINE TYPE]	Each press switches the line type in the following sequence. Solid line → Dotted line → Dot-dash line → Two dot-dash line → Solid line ...
[DISPLAY AIS TRACK]	Each press shows or hides AIS tracks alternately.
[DISPLAY CNSRT TRACK]	Each press shows or hides consort tracks alternately.
[DISPLAY TT TRACK]	Each press shows or hides TT tracks alternately.
[DISPLAY GPS BUOY TRK]	Each press shows or hides GPS buoy tracks alternately.

Function	Description
[EDIT MARK]	Opens the [EDIT MARK] window.
[DELETE MARK]	Opens the [DELETE MARK] window.
[INPUT MARK]	Opens the [INPUT MARK] window.
[EDIT TRACK]	Opens the [EDIT TRACK] window.
[DELETE TRACK]	Opens the [DELETE TRACK] window.
[DELETE ALL TRACK]	Deletes all own ship tracks.
[ALARM SETTING]	Opens the [ALARM SETTINGS] menu.
[NAV AIDS DISPLAY]	Each press shows or hides navigation data alternately.
[CONTOUR LINE DISPLAY]	Each press shows or hides depth contours alternately.
[RESET TRIP LOG]	Resets trip distance to zero.
[DELETE OTHER SHIPS' TRACK]	Opens the [DELETE OTHER SHIPS' TRACK] window.
[SCREENSHOT]	Saves screenshot data to the internal memory.
[REDO]	Redoes the last undo action for mark/line input, edit or deletion.
[CHANGE OPERATION DISPLAY]	Switches the active screen in the split screen.
[FISH FINDER SHIFT]	Opens the [FISH FINDER SHIFT] window in the manual echo sounder mode.
[FISH FINDER DEPTH RANGE]	<ul style="list-style-type: none"> • Opens the [BTM DISP RNG U (or L)/LIM] window in the automatic echo sounder mode. • Opens the [FISH FINDER RANGE] window in the manual echo sounder mode.
[FISH FINDER GAIN]	<ul style="list-style-type: none"> • Opens the [AUTO GAIN OFFSET (HF) (or (LF))] window in the automatic echo sounder mode. • Opens the [FISH FINDER GAIN (HF) (or (LF))] window in the manual echo sounder mode.
[FISH FINDER AUTO]	Opens the [AUTO] window on the echo sounder display.
[FISH FINDER INT REJ]	Opens the [INT. REJ. SETTINGS] window on the echo sounder display.
[FISH FINDER CLUTTER]	Opens the [CLUTTER] window on the echo sounder display.
[FISH FINDER WHITE MARKER]	Opens the [WHITE MARKER SETTING] window on the echo sounder display.
[FISH FINDER HUE]	Opens the [HUE] window on the echo sounder display.
[FISH FINDER SIGNAL LEVEL]	Opens the [ERASING WEAK ECHOES] window on the echo sounder display.
[FISH FINDER PIC. ADV.]	Opens the [PICTURE ADVANCE] window on the echo sounder display.
[SEND MARKS TO RADAR]	Sends mark data to the FR-12 (with RT board). The confirmation message appears. Select [RUN].
[SWITCH AIS DISPLAY]	Each press shows or hides AIS display (tracks and symbols) alternately. Note: While running the [TARGET SMART TRACK] (see page 9-15), even if the AIS display is hidden, [TARGET SMART TRACK] remains active.

6. Press the **DISP** key to close the menu.

1.8 Demo Mode

The demo mode, available with both the plotter and echo sounder (connection of transducer is not required), provides simulated operation of this unit. All controls are operational. Use it in port or the like to acquaint yourself with the features of your unit.

When the demo mode is active, the indication [DEMO] appears at the top right of the display.

Plotter

Own ship mark moves from the default position at the course and speed set.

1. Press the **MENU** key to open the main menu.
2. Select [0. SYSTEM SETTING].
3. Select [7. DEMO MODE].

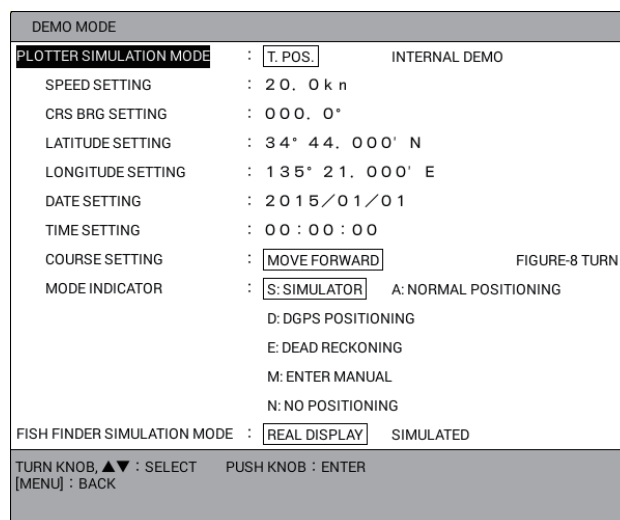

4. Select [PLOTTER SIMULATION MODE].
5. Select [INTERNAL DEMO].
6. Select [SPEED SETTING].
7. Use the numeric keys to enter speed.
8. Select [CRS BRG SETTING].
9. Use the numeric keys to enter direction.
10. Select [LATITUDE SETTING].
11. Use the numeric keys to enter latitude. Use the **CURSOR ON/OFF** key to switch the coordinate between north and south and vice versa.
12. Select [LONGITUDE SETTING].
13. Use the numeric keys to enter longitude. Use the **CURSOR ON/OFF** key to switch the coordinate between east and west and vice versa.
14. Select [DATE SETTING].
15. Use the numeric keys to enter the start date.

Note: When the [BEARING MODE] menu is set to [MAGNETIC DIR.] (see page 9-11), “- -” is displayed for the magnetic bearing (COG, heading, bearing to waypoint) if setting the date before 2020.
16. Select [TIME SETTING].
17. Use the numeric keys to enter the start time, in 24-hour notation.

18. Select [COURSE SETTING].
 19. Select [MOVE FORWARD] or [FIGURE-8 TURN].
[MOVE FORWARD]: Track is traced according to the course set.
[FIGURE-8 TURN]: Track is traced in figure-eight course.
 20. Select [MODE INDICATOR].
 21. Select one of the following:
[S: SIMULATOR]: Use the position data provided with the built-in simulator.
[A: NORMAL POSITIONING]: Use GPS position data.
[D: DGPS POSITIONING]: Use DGPS position data.
[E: DEAD RECKONING]: Use dead reckoning position data.
[M: ENTER MANUAL]: Use manually entered position, course, etc.
[N: NO POSITIONING]: Use no position data.
 22. Press the **DISP** key to close the menu.
- To stop the demo mode, select [T. POS.] at step 5.

Echo sounder

1. Press the **MENU** key to open the main menu.
 2. Select [0. SYSTEM SETTING].
 3. Select [7. DEMO MODE].
 4. Select [FISH FINDER SIMULATION MODE].
 5. Select [SIMULATED].
 6. Press the **DISP** key to close the menu.
- To stop the demo mode, select [REAL DISPLAY] at step 5.

1.9 How to Install Charts

Note: Save the chart data to a USB flash memory first. You do not need to create a folder.

1. Connect the USB flash memory with chart data to the USB drive.
2. Press the **MENU** key to open the main menu.
3. Select [0. SYSTEM SETTING].
4. Select [0. MAINTENANCE].
5. Select [3. UPDATE CHART]. The following message appears.

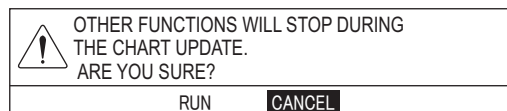

6. Select [RUN]. The message "PROCESSING. PLEASE WAIT." appears, then the [CHART ADMINISTRATION] menu appears.

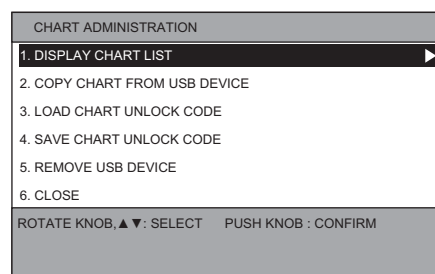

1. OPERATIONAL OVERVIEW

7. Select [2. COPY CHART FROM USB DEVICE] to display the list for data in the USB flash memory.

CHART COPY		SEL. PAGE_ 1/1
SELECT CHART TO COPY		
CHART NAME		CHART DATE
xxxxxxxxxxxxxxxxxxxxx.uc		2018/xx/xx
xxxxxxxxx.dbh		2018/xx/xx
xxxxxxxxx.dbh		2018/xx/xx
xxxxxxxxx.dbh		2018/xx/xx
xxxxxxxxx.dbh		2018/xx/xx
xxxxxxxxx.dbh		2018/xx/xx

- a) Selected file (The letters are displayed in the color selected on the [BKGD/ LETTER COLOR] menu.)
 - b) Current selected position (The background is displayed in the reverse color to that selected on the [BKGD/LETTER COLOR] menu.)
 - c) Non-selected file
8. Select all charts to be installed.
 9. Select [SELECT CHART TO COPY]. The confirmation message appears.
 10. Select [RUN] to start copying the charts. The estimate of the copying time is approx. 13 minutes 30 seconds at approx. 10 GB.
 11. Push the **ENTER** knob.
 12. Do one of the following methods to unlock the chart data.
How to unlock the chart data automatically
Note: Save the unlock code to the USB flash memory first. The file extension is "uc".
 - 1) Select [3. LOAD CHART UNLOCK CODE] in the [CHART ADMINISTRATION] menu to display the list for data in the USB flash memory.
 - 2) Select the file for the unlock code. The confirmation message appears.
 - 3) Select [RUN]. The message "UNLOCK CODE VERIFIED." appears.
 - 4) Push the **ENTER** knob.How to unlock the chart data manually
 - 1) Select [1. DISPLAY CHART LIST] in the [CHART ADMINISTRATION] menu to display the chart list.
 - 2) Select the locked chart data (displayed with red letters), then press the **CURSOR ON/OFF** key to display the character entry window.
 - 3) Set the unlock code as described below.
Rotate the **ENTER** knob to select a character, then push the knob to confirm selection. Repeat this step to select all other characters. Select [ENTER] then push the knob.
The message "UNLOCK CODE VERIFIED." appears.
 - 4) Push the **ENTER** knob.
 13. When unlocking the chart data automatically, select [5. REMOVE USB DEVICE]. The message "USB DEVICE CAN BE SAFELY REMOVED." appears. Push the **ENTER** knob then remove the USB device.
 14. Select [6. CLOSE]. The confirmation message appears.
 15. Select [RUN]. The system restarts.

2. PLOTTER DISPLAY OVERVIEW

The plotter display can be shown on the full screen with or without the NAV information box, or in a two- or three-way horizontal or vertical split screen with the compass display or the echo sounder display.

2.1 Plotter Display

2.1.1 Plotter display layout

The plotter display shows chart data, tracks, waypoints, marks, etc. Use it to monitor ship's progress toward a destination.

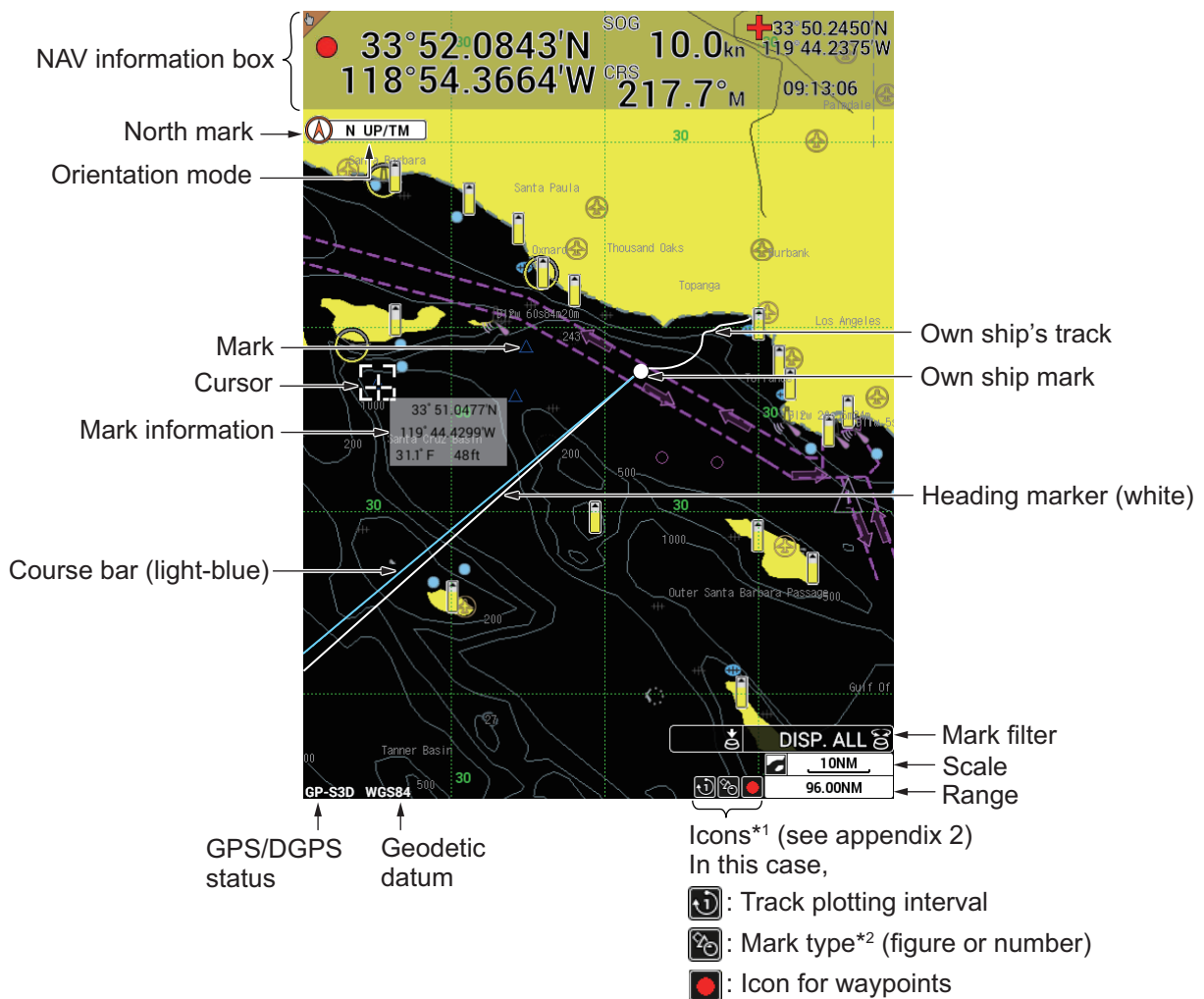

*¹: If more than seven icons are displayed in the vertical split screen, they will appear in two rows (top and bottom).

*²: The maximum number of display points on the screen is 3,000. The excess points are thinned out (culled). During the culling process, the icon for the mark type changes from white to yellow.

2.1.2 NAV information box

The NAV information box is displayed at the top or bottom of the screen. You can select the data to show both when a destination is set and no destination set (see section 1.4.2, section 1.4.4).

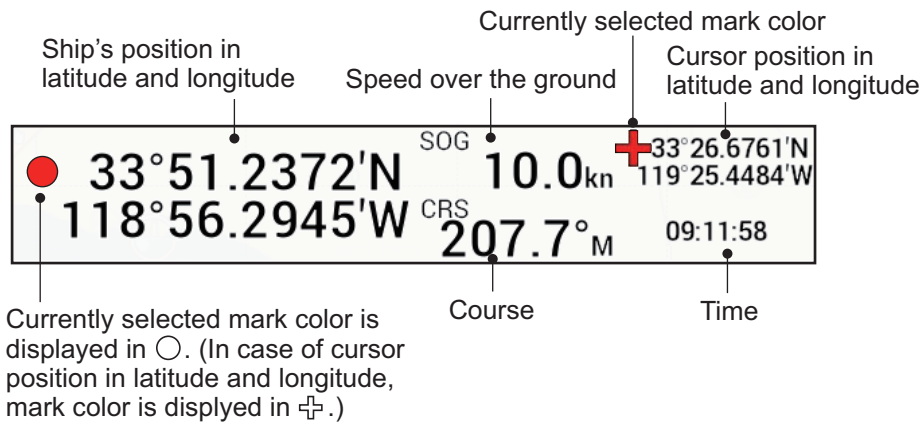

Example for navigation information (no destination set)

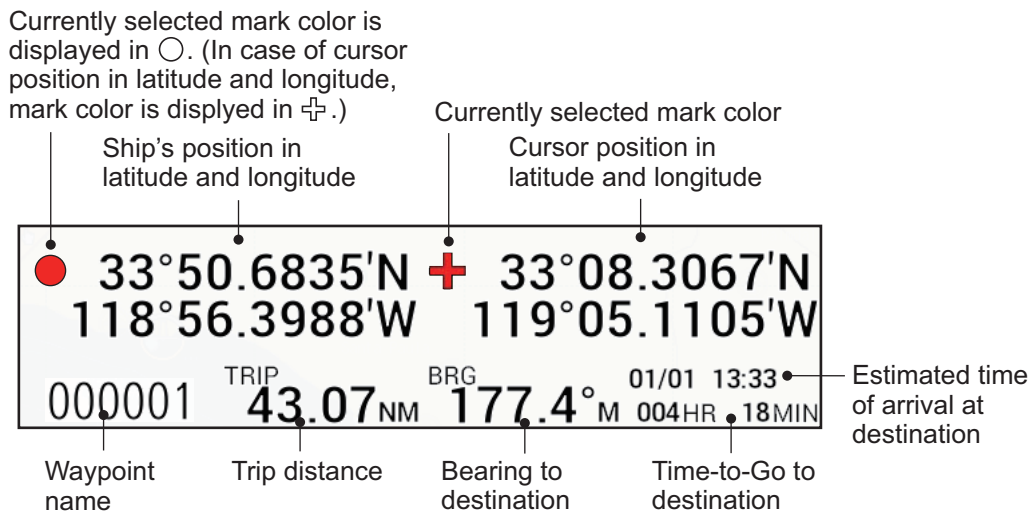

Example for destination information (with destination set)

2.1.3 Compass display

The compass display, displayed at the top of the screen in a horizontal split 1:1 screen, provides steering information toward a destination.

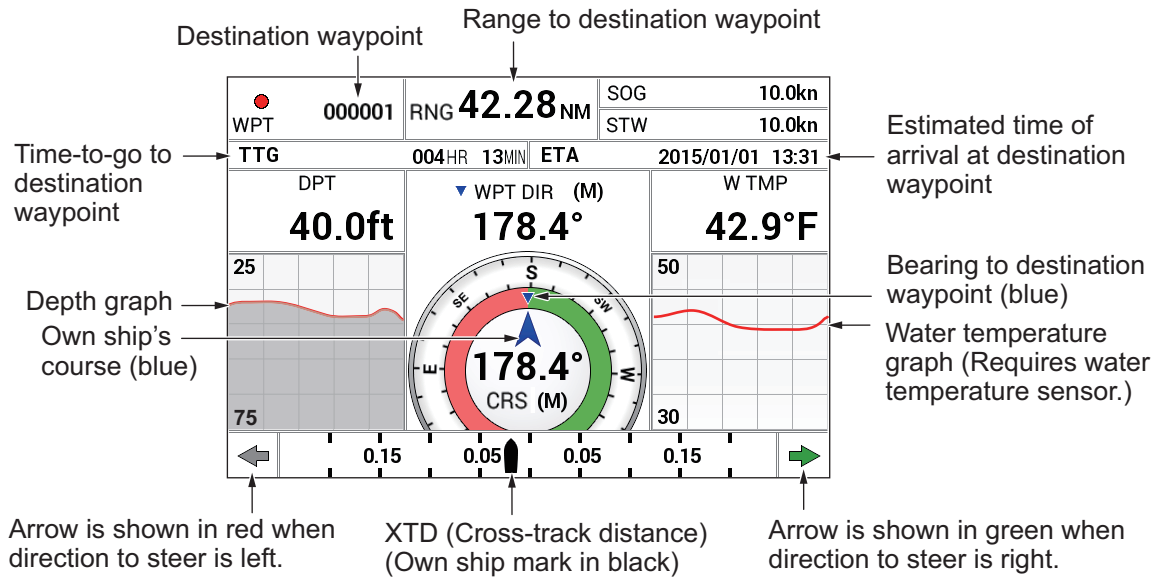

Compass indicator

The blue inverted triangle (▼) shows the bearing to the destination waypoint, and the blue arrow (▲) shows own ship course.

Note: The course means the direction of own ship's movement, not the direction of heading. The course includes the affect of current and wind.

Depth and water temperature graphs

The depth and water temperature graphs, which require appropriate sensors, show the latest 10 minutes of depth and water temperature data. The range of the depth graph is 50 feet and it is automatically adjusted with depth.

XTD (Cross track distance) monitor

The own ship mark (●) shows ship's cross-track distance from the intended course. The mark is shown in black when the amount of cross-track distance is within the XTD monitor range, and hollow when it is over. An arrow appears at the right or left side of the XTD monitor and it shows the direction to steer to return to the intended course. The arrow points left and is red when you should steer left, and points right and is green when you should steer right. To maintain course, steer the vessel so the own ship mark stays at the center of the XTD monitor.

2.1.4 Satellite status/location display

The satellite status/location display provides data about the GPS satellites and GEO satellite (for WAAS). To display the satellite status/location display, do the following:

1. Press the **MENU** key to open the main menu.
2. Select [8. PLOTTER DISPLAY SETTING].

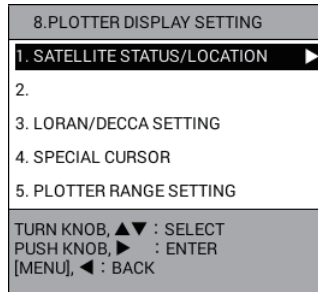

3. Select [1. SATELLITE STATUS/LOCATION] to display the satellite status/location display. Push the knob to cycle through the available displays, ALL→GPS→SBAS/QZSS, The figure below shows the “ALL” display.

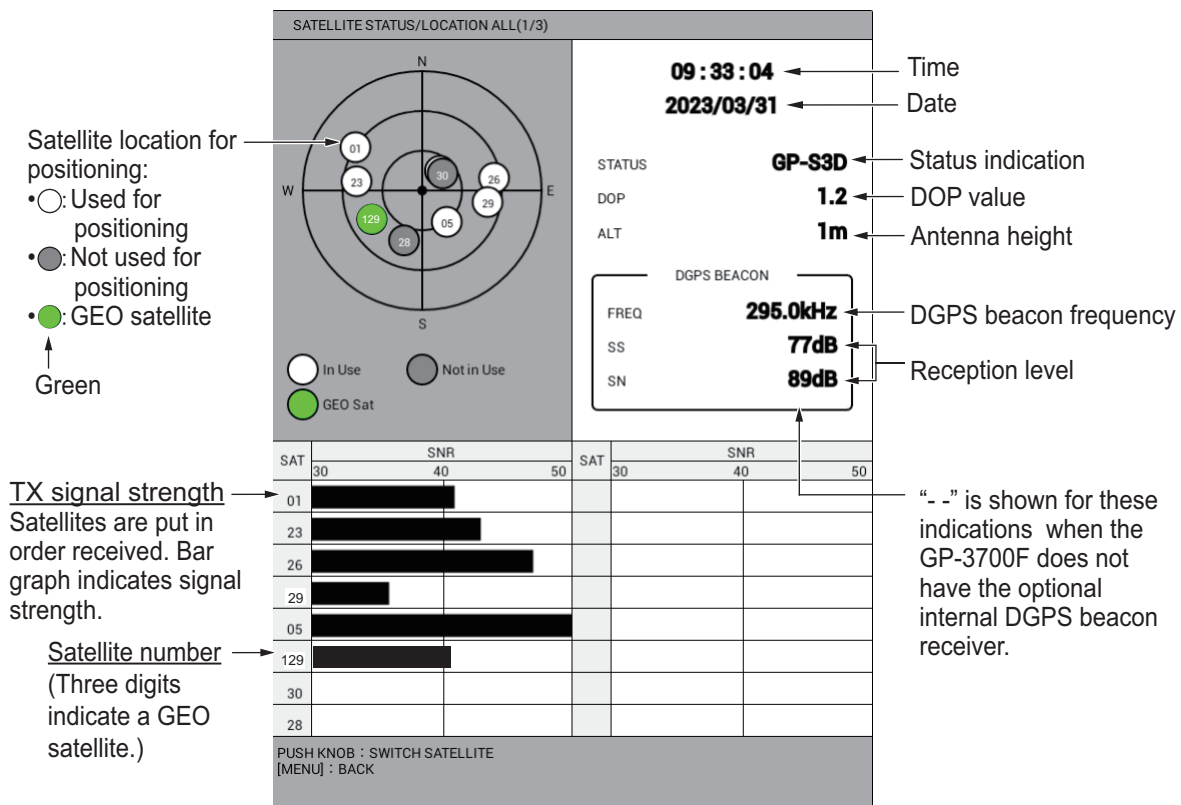

DOP: DOP stands for Dilution of Precision and is an indication of the quality of the satellite constellation. The smaller value means the higher accuracy. (For your reference, the positioning accuracy is approx. 10 m when the value is less than “4”.)

SS: SS (Signal Strength) displays a numeric representation of electrical field strength of the received signal on the selected frequency. The higher the number the stronger the received signal, and a figure above 60 is normal.

SN: SN (Signal-to-Noise) ratio displays the ratio between the desired signal and unwanted noise on the selected frequency. The higher the SN ratio the better the quality of the signal, and a figure above 21 is normal.

4. Press the **DISP** key to close the satellite status/location display and the menu.

2.1.5 Tide graph display

To display the tide graph, put the cursor on the tidal station icon () then push the **ENTER** knob.

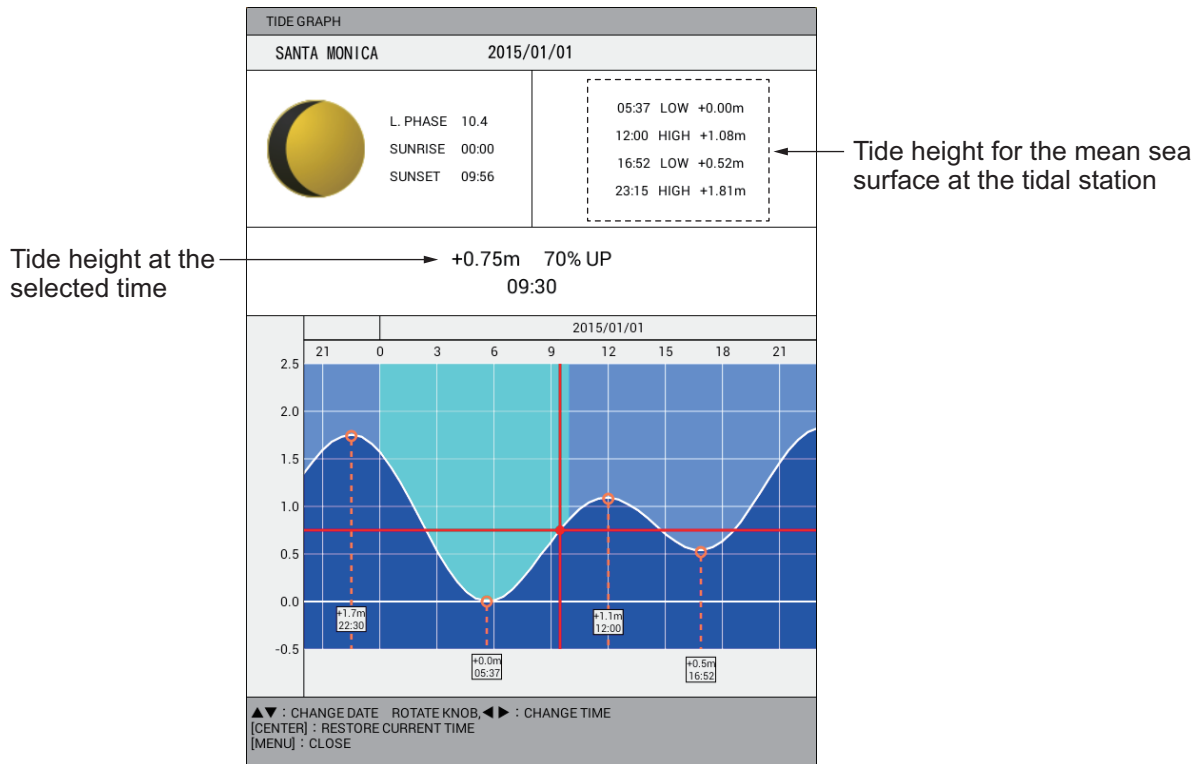

- The information is mostly accurate under moderate weather conditions. However, storms and weather fronts can influence forecasted tide times and heights.
- To change the date, press ▲ or ▼ key.
- To change the tide prediction time, rotate the **ENTER** knob or press ◀ or ▶ key to move the vertical red line on the graph.
- To restore the display to the current time, press the **CENTER** key.
- To quit the tide graph display and return to the plotter display, press the **MENU** key (or the **DISP** key).

Tidal station icon

The arrow on the tidal station icon is up when the tide is rising; down when the tide is receding. The icon is gray and yellow according to the tide state. The icon is all yellow when the tide is high. The horizontal line appears in the center of the icon when there is no change in tide.

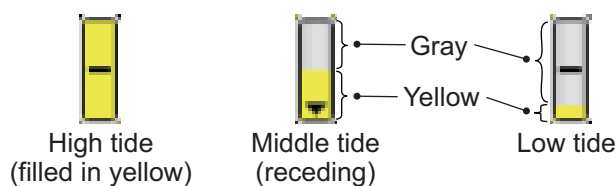

2.2 How to Use the Cursor

The cursor functions to select position for marks and waypoints, find position of an object, etc. You can select the cursor shape from crossing line and cross-hair.

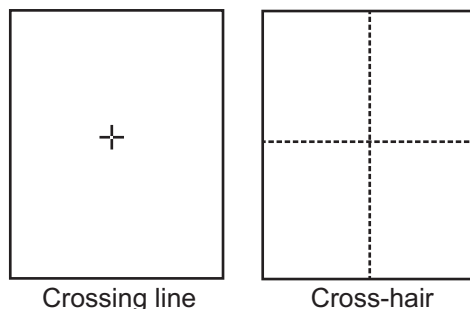

To use the cursor, do the following:

1. Press the **CURSOR ON/OFF** key to turn on the cursor. Each press of this key turns the cursor on and off.

Note: You can change the shape or color for the cursor in the [DISPLAY FORMAT] - [CURSOR SHAPE] or [CURSOR COLOR] menus (see page 9-14).
2. Do one of the following to move the cursor.
 - Rotate the trackball. The cursor moves in the direction of trackball rotation.
 - Press ▲, ▼, ◀, or ▶ (CursorPad). The cursor moves in the direction of the arrow operated. You can hold down an arrow pad to move the cursor faster. To move the cursor at a slant angle, press the appropriate arrow pads together. For example, to move the cursor in the left-up direction (approx. 315°), press ▲ and ◀ together.

The procedures in this manual, for sake of brevity, replace the “rotate” and “press” actions with “move the cursor”.

When the cursor reaches an edge of the screen, the display is scrolled in the opposite direction. When the cursor is turned on, the cursor position is displayed in the NAV information box when [CURSOR LATITUDE, LONGITUDE] is set as the navigation/destination information (see section 1.4.4).

3. To put the cursor at the center of the screen, press the **CENTER** key.

2.3 How to Change the Chart Scale (Zoom In, Zoom Out)

It can be useful to change the chart scale to

- show destination on the display (when it is currently off the screen)
- find how close you are to your destination
- view ship's tracks around a fishing ground

Press the **ZOOM IN** key to increase the chart scale, or the **ZOOM OUT** key to decrease the chart scale.

When the cursor is OFF: When own ship mark is displayed on the screen, the range scale is enlarged or shrunk with own ship position kept on the screen. When own ship mark is not displayed on the screen, the range scale is enlarged or shrunk with the middle of the screen as center.

When the cursor is ON: The range scale is enlarged or shrunk with the cursor position as center.

The current range appears at the bottom right of the screen. The range value shows the distance between the left-side and right-side edges of the screen.

Range (Unit: NM)

0.025	0.05	0.075	0.10	0.125	0.25	0.50	0.75	1.00
1.50	2.00	3.00	4.00	6.00	8.00	12.0	16.0	24.0
32.0	48.0	72.0	96.0	128	256	512	1024	

Note 1: You can select what ranges to use. See section 9.2.2.

Note 2: The width of the screen can be shown in scale or distance (default). You can also turn off the width indication. See page 9-12.

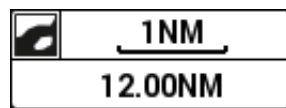

Range (distance)

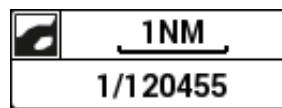

Scale

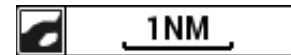

No indication

2.4 Orientation Mode

The display orientation for the plotter display can be selected to the following six modes. Press the **MODE** key to change the orientation mode.

North up: True north (0°) is at the top of the screen. When the heading changes, own ship mark moves according to heading or COG. This mode is for long-range navigation.

Head up: Displays the chart with the current compass heading of own ship at the top of the screen. When the heading changes, own ship mark remains fixed, and the chart picture rotates according to the heading.

AC up: The course is at the top of screen at the moment the auto course-up mode is selected. When the course changes more than the set angle, the picture resets to display the course at the moment at the top of the screen (see page 9-19).

Course up: The set course to the destination is at the top of the screen when the destination is set.

Goto up: The destination is at the top of the screen when the destination is set.

Specified direction up: The specified direction set in the menu is at the top of the screen. To set the specified direction, do the following:

1. Press the **MENU** key to open the main menu.
2. Select [0. SYSTEM SETTING].

2. PLOTTER DISPLAY OVERVIEW

3. Select [2. NAVIGATOR SETUP].

NAVIGATOR SETUP		SEL. PAGE 1/2	
SELECT NAV SOURCE	: [INTERNAL]	GPS	LORAN C
		ALL	
TIME DIFFERENCE	: + 0 9 : 0 0		
NMEA TIME DIFFERENCE	: + 0 0 : 0 0		
DATUM	: [WGS-84]	TOKYO	
POSITION SMOOTHING	: 0 0 0		
SPEED SMOOTHING	: 0 0 0		
SPEED AVERAGING	: 0 6 0		
NMEA SPEED AVERAGING	: 0 6 0		
LATITUDE OFFSET	: 0 . 0 0 0 ' N		
LONGITUDE OFFSET	: 0 . 0 0 0 ' E		
DISABLE SATELLITE(GPS)	: --- --- ---		
ANTENNA HEIGHT	: 0 5 m		
GPS FIX MODE	: 2 D	[2 D / 3 D]	
DIFFERENTIAL POSITIONING	: DGPS	SBAS	AUTOMATIC
	[NO]	QZSS	

TURN KNOB, ▲▼ : SELECT PUSH KNOB : ENTER
[0]~[9] : NO. OF PAGE ◀▶ : MOVE PAGE
[MENU] : BACK

[NAVIGATOR SETUP] menu: Page 1



NAVIGATOR SETUP		SEL. PAGE 2/2	
DIFFERENTIAL POSITIONING ALARM	: ON	[OFF]	
DGPS BEACON STATION	: [AUTOMATIC]	MANUAL	
FREQUENCY SETTINGS	: 2 9 5 . 0 k H z		
DGPS BAUD RATE	: 50	100	[200]
SBAS SATELLITE SEL.	: [AUTOMATIC]	MANUAL	
SBAS MAN. SAT. SET.	: 1 3 4		
DISABLE SATELLITE(SBAS)	: --- --- ---		
DISABLE SATELLITE(QZSS)	: --- --- ---		
COURSE UP REDRAW ANGLE	: 2 2 . 5°	(20.0 to 60.0)	
FREE UP ANGLE	: 0 0 0°		
COURSE SMOOTHING	: 0 0 0		
ROLLOVER	: 2 0 3 4		
RTE SENTENCE	: [LEGACY]	DNV	

TURN KNOB, ▲▼ : SELECT PUSH KNOB : ENTER
[0]~[9] : NO. OF PAGE ◀▶ : MOVE PAGE
[MENU] : BACK

[NAVIGATOR SETUP] menu: Page 2

4. Select [FREE UP ANGLE] on page 2.
5. Use the numeric keys to enter angle.
6. Press the **DISP** key to close the menu.

2.5 How to Shift the Display

The display can be shifted on the plotter display.

1. If the cursor is displayed, press the **CURSOR ON/OFF** key to turn off the cursor.
2. Operate the trackball. The display shifts in the direction in which the trackball is rolled.
3. Press the **CENTER** key.
 - In north up or specified direction up mode, own ship mark is returned to the center of the screen.
 - In head up, AC up, course up or goto up mode, own ship mark is shifted to a position that is 1/3 the distance from the bottom to the top of the screen.

Note: When own ship reaches an edge of the screen, the own ship mark is automatically shifted sternward so there is some distance between the bow of the mark and the edge of the screen.

2.6 How to Measure the Range and Bearing Between Two Points

You can measure the range and bearing between any two points on the plotter display.

1. If the cursor is displayed, press the **CURSOR ON/OFF** key to turn off the cursor.
2. Press the **0** key. A dashed circle appears with the red "X" mark at its center and a dashed line extends from the "X" mark to the cursor. The [BTWN] data box appears at the top left of the screen.

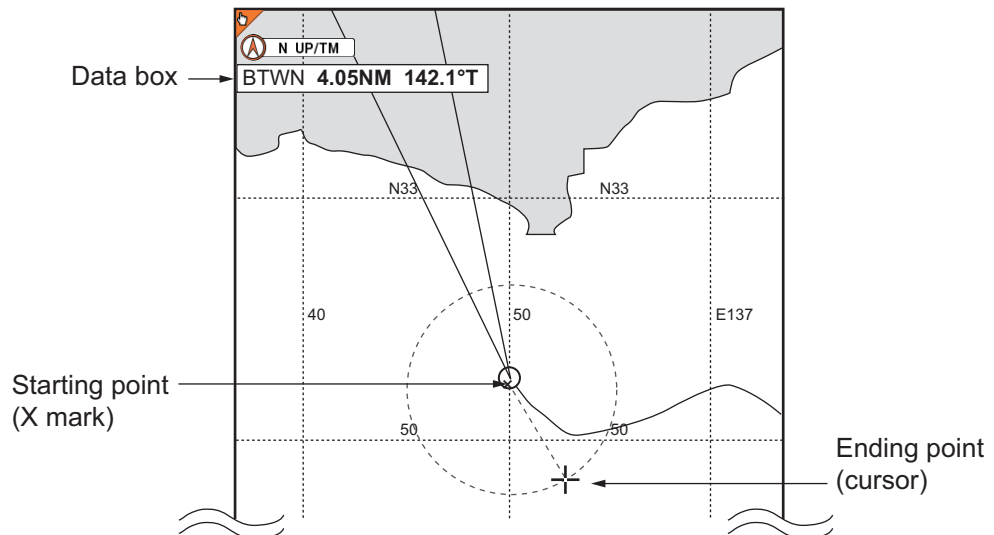

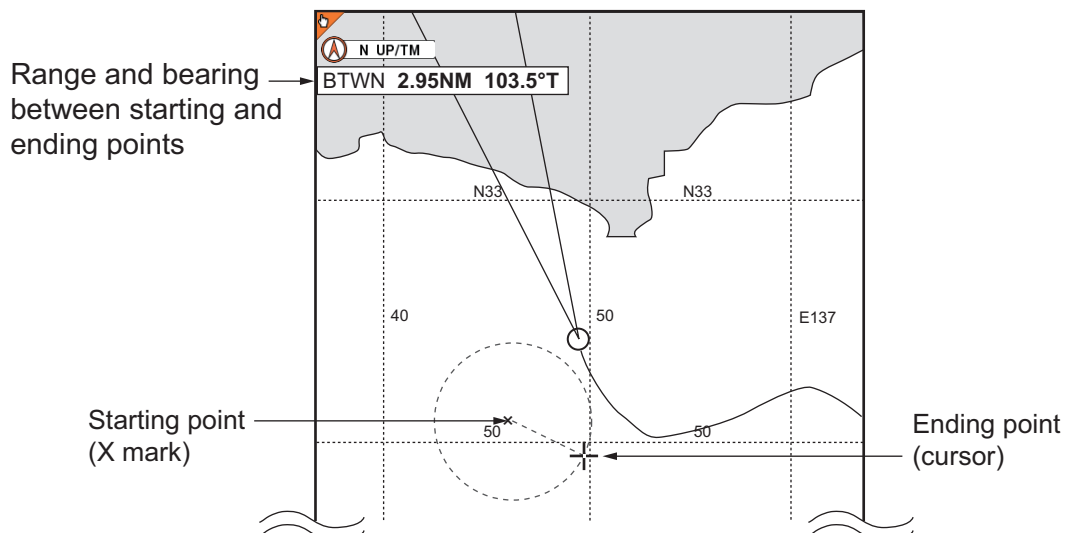

3. Use the trackball to put the cursor on the starting point.
4. Push the **ENTER** knob then the "X" mark moves to the cursor position.
5. Use the trackball to put the cursor on the ending point. The [BTWN] (Between) data box shows the range and bearing between the starting and ending points.



6. Press the **0** key to terminate the measurement and erase the dashed circle, line, and data box.

2.7 How to Change the Cursor Configuration

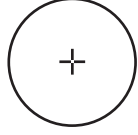
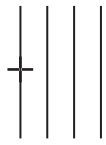
The cursor is available in four configurations; crossing line, circle, parallel index line, and diamond. When the cursor is turned on, the selected cursor is displayed with a focus on the cursor. When the cursor is turned off, the selected cursor is displayed with a focus on own ship mark. The configuration for the standard cursor in the table below is “crossing line”.

Configuration	Appearance	Usage
Crossing line		General use. Select position for mark; select mark to erase; select target (TT, AIS) to display its data, etc.
Circle		Measure range between two objects (including own ship).
Parallel index line		Maintain distance between own ship and coastline, another vessel.
Diamond		Mark location of fishing net.

Note: Hereafter, “cursor” means the crossing line cursor, unless otherwise noted.

The **CURSOR ON/OFF** key shows or hides the cursor.

To change the cursor configuration, do as follows:

- Press the **CURSOR SEL** key to select the cursor to use.

When crossing line or cross-hair cursor is displayed: Each time you press the key, the cursor configuration changes as follows:
Circle → Parallel index line → Diamond → Crossing line / cross-hair → circle → ...

When crossing line or cross-hair cursor is not displayed: Each time you press the key, the cursor configuration changes as follows:
Circle → Parallel index line → Diamond → No indication → circle → ...

Note 1: You can disable unnecessary cursors except the crossing line/cross-hair cursor. See "How to disable unnecessary cursors" on page 2-11.

Note 2: When the cursor is not displayed, the selected cursor can move with the own ship mark.
- For the cursor other than the crossing line or cross-hair cursor, use the **ENTER** knob to adjust the selected cursor.

Circle: Rotate the knob to change the radius of the circle. Push the knob to anchor the circle. The radius of the circle is displayed at the top left of the screen.

Parallel index line: Rotate the knob to rotate the line(s), then push the knob. Rotate the knob to adjust the interval between index lines. Push the knob when finished. The orientation and interval for the index lines are displayed at the top left of the screen. You can select the number of parallel index lines to display and the orientation method (see "How to set the orientation method and the number of parallel index lines" on page 2-11).

Diamond: Rotate the knob to rotate the diamond. Push the knob to anchor the di-

amond. You can scale the diamond to match the size of your fishing net. The angles for casting net is displayed at the top left of the screen. To change the size of the diamond, see "How to change the size of the diamond cursor" on page 2-12.

How to disable unnecessary cursors

1. Press the **MENU** key to open the main menu.
2. Select [8. PLOTTER DISPLAY SETTING].
3. Select [4. SPECIAL CURSOR].

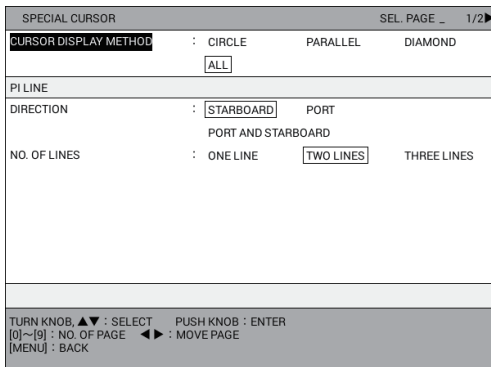

[SPECIAL CURSOR] menu: Page 1

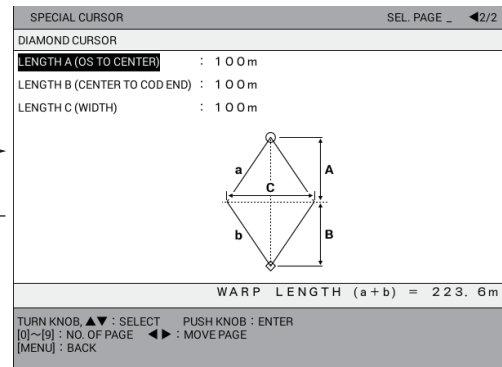

[SPECIAL CURSOR] menu: Page 2

4. Select [CURSOR DISPLAY METHOD] on page 1.
5. Select [CIRCLE], [PARALLEL], [DIAMOND] or [ALL]. Only the selected cursor is made available when pressing the **CURSOR SEL** key. For example, when selecting [CIRCLE], the cursor configuration changes as follows:
Circle → Crossing line / cross-hair → Circle → ...
Select [ALL] to turn on all cursor configurations.
6. Press the **DISP** key to close the menu.

How to set the orientation method and the number of parallel index lines

1. Press the **MENU** key to open the main menu.
2. Select [8. PLOTTER DISPLAY SETTING].
3. Select [4. SPECIAL CURSOR].
4. Select [DIRECTION] in [PI LINE] on page 1.
5. Select the orientation method.
[STARBOARD]: Displays parallel index lines to starboard.
[PORT]: Displays parallel index lines to port.
[PORT AND STARBOARD]: Displays parallel index lines to port and starboard.
6. Select [NO. OF LINES] in [PI LINE] on page 1.
7. Select the number of parallel index lines.
8. Press the **DISP** key to close the menu.

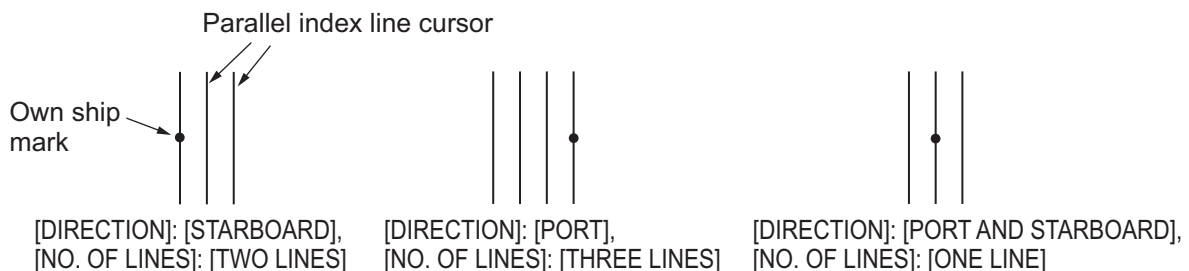

How to change the size of the diamond cursor

1. Press the **MENU** key to open the main menu.
2. Select [8. PLOTTER DISPLAY SETTING].
3. Select [4. SPECIAL CURSOR].
4. Select [LENGTH A (OS TO CENTER)] in [DIAMOND CURSOR] on page 2.
5. Referring to the figure, use the numeric keys to set the distance from own ship to the center of the diamond.
6. Set [LENGTH B (CENTER TO COD END)] and [LENGTH C (WIDTH)] in the same manner.
7. Press the **DISP** key to close the menu.

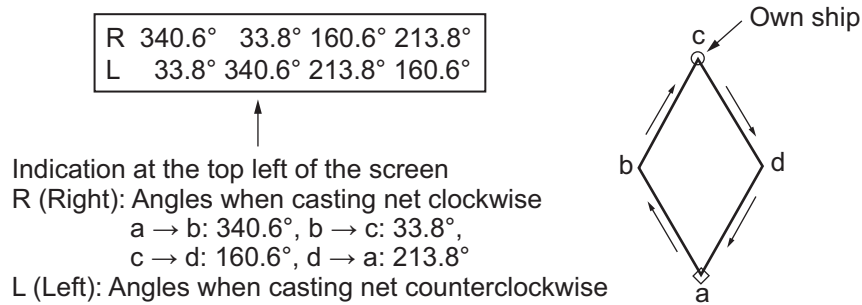

2.8 Chart Icons

The chart icon at the bottom right of the screen changes according to the state of the chart. See the table below.

Icon	Meaning
	Suitable chart scale.
	Unsuitable chart scale. Press the ZOOM IN or ZOOM OUT key to adjust the chart scale.
	No chart file.

The chart scale is displayed on the right side of the icon. The scale value and scale width change according to the selected range.



3. TRACK

Own ship track is plotted on the plotter display using position data fed from the built-in GPS receiver. When connecting with a ARPA-equipped radar or a TT-equipped radar, other ship's track can also be plotted.

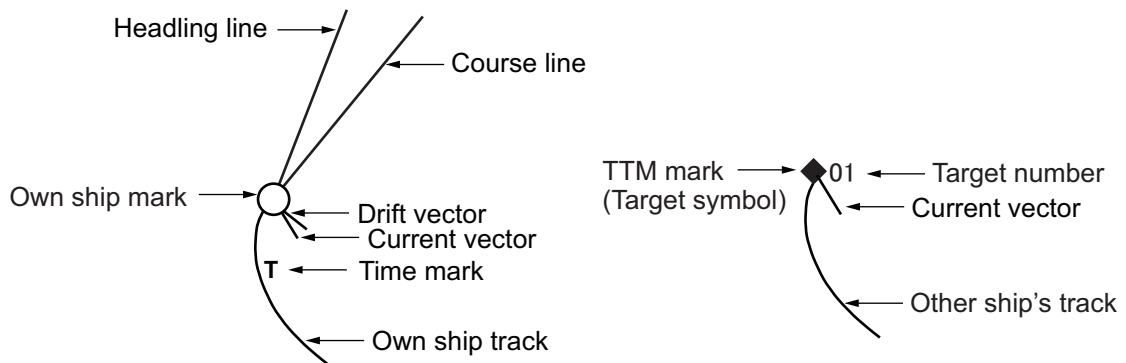

The own ship track or other ship's track can be saved as a route (see section 6.1.3).

3.1 How to Show/Hide Track

3.1.1 How to show/hide own ship track

Own ship track is shown by default.

1. Press the **MENU** key to open the main menu.
2. Select [4. MARK/TRACK SETTING].

MARK/TRACK SETTING		SEL. PAGE	1/6
MARK SIZE	: <input type="text" value="LARGE"/>	LARGE WITH DOT	
		SMALL	
SHOW MARK COMMENTS	: <input type="text" value="ON CHART"/>	IN POPUP	
		<input type="text" value="IN INFORMATION"/>	
NUMBER OF RUN DATA MARKS TO DISPLAY	: <input type="text" value="DEFAULT"/>	MAXIMUM NUMBER OF MARKS	
DISPLAY OF DUPLICATE RUN DATA MARKS	: <input type="text" value="UNLIMITED"/>	LIMITED	
DISPLAY DUPLICATE INTERNAL MARKS	: <input type="text" value="UNLIMITED"/>	LIMITED	
LINE TYPE	: <input type="text" value="—"/> <input type="text" value="----"/> <input type="text" value=".-.-"/> <input type="text" value="...."/>		
AUTO RECORD SETTING	: <input type="text" value="SCREEN SHOT WHEN MARK INPUT"/>		
		NO	
TRACK INTERVAL 1	: <input type="text" value="TIME"/>	RANGE	
TIME INTERVAL	: 0 O.M. 1 O.S. (MAX 3D11H)		
RANGE INTERVAL	: 0. 1 ONM		
TRACK INTERVAL 2	: TIME	<input type="text" value="RANGE"/>	
TIME INTERVAL	: 0 O.M. 1 O.S. (MAX 3D11H)		
RANGE INTERVAL	: 0. 1 ONM		
TURN KNOB, ▲▼ : SELECT PUSH KNOB : ENTER			
[0]~[9] : NO. OF PAGE ◀▶ : MOVE PAGE			
[MENU] : BACK			

3. TRACK

3. Go to page 2, then select [DISPLAY TRACKS].

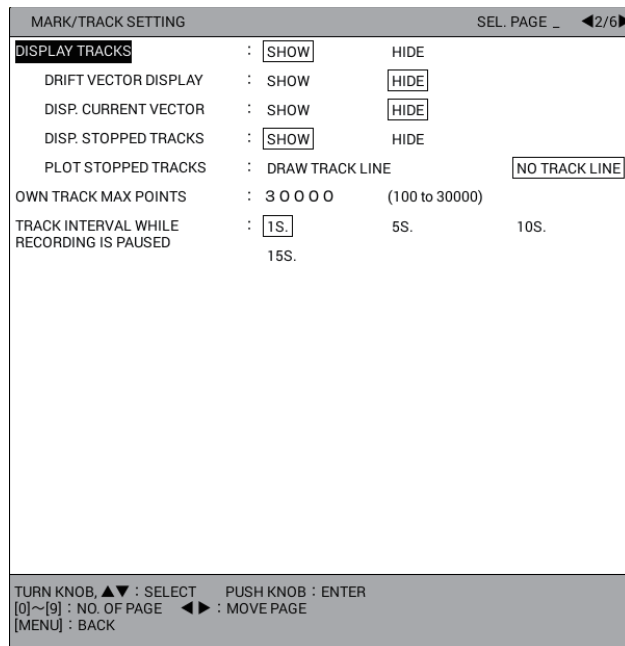

4. Select [SHOW] to show own ship track or [HIDE] to hide own ship track.
5. Press the **DISP** key to close the menu.

How to change the memory capacity for own track

The default memory capacity for track is 30,000 points. If you don't need to record that many track points, you can change the memory capacity as shown below. If the number of track points currently saved in the memory exceeds the track memory capacity, the oldest points over the capacity are erased. If you require the points, save them to an internal memory (see section 10.2.1) or a USB flash memory (see section 10.3.3).

1. Press the **MENU** key to open the main menu.
2. Select [4. MARK/TRACK SETTING].
3. Select [OWN TRACK MAX POINTS] on page 2.
4. Press the numeric keys to enter the max. memory points for own track. The following confirmation message appears.

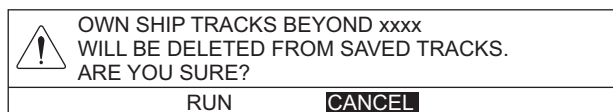

xxxx: Setting value

5. Select [RUN].
6. Press the **DISP** key to close the menu.

Time mark

The time marks "T" are displayed on the own ship track every hour on the hour by default (see the figure at the top left on page 3-1). To hide the time marks or show the number of hour with "T" mark, such as "T01", do the following:

1. Press the **MENU** key to open the main menu.
2. Select [4. MARK/TRACK SETTING].
3. Select [DISPLAY TIME MARK] on page 3.

MARK/TRACK SETTING		SEL. PAGE _ ◀3/6▶	
TRACK COLOR BY TEMP	: RANGE	EV. 0.2	EV. 2.0
DISPLAY BELOW ITEMS WITH WHITE CHARACTERS			
BLUE	: + 4 0. 0°F		
PURPLE	: + 5 0. 0°F		
LIGHT BLUE	: + 5 5. 0°F		
GREEN	: + 6 0. 0°F		
YELLOW	: + 6 5. 0°F		
RED	: + 7 0. 0°F		
TRACK COLOR BY DEPTH	: RANGE	EV. 2	EV. 20
	EV. 200		
DISPLAY BELOW ITEMS WITH WHITE CHARACTERS			
BLUE	: 0 0 3 0. 0 f t		
PURPLE	: 0 1 5 0. 0 f t		
LIGHT BLUE	: 0 3 0 0. 0 f t		
GREEN	: 0 6 0 0. 0 f t		
YELLOW	: 0 9 0 0. 0 f t		
RED	: 1 2 0 0. 0 f t		
DISPLAY TIME MARK	: SHOW(T)	HIDE	SHOW(Thh)
TURN KNOB, ▲▼ : SELECT PUSH KNOB : ENTER			
[0]~[9] : NO. OF PAGE ◀▶ : MOVE PAGE			
[MENU] : BACK			

4. Select [HIDE] to hide the time marks. Select [SHOW (Thh)] to show the number of hour with "T" mark.
5. Press the **DISP** key to close the menu.

3.1.2 How to show/hide other ship's tracks and symbols

Other ship's (AIS, TT, GPS BUOY) tracks and symbols are shown or hidden individually.

1. Press the **MENU** key to open the main menu.
2. Select [4. MARK/TRACK SETTING].
3. Open page 4. For other ship's tracks, select [DISPLAY AIS TRACK] (see section 12.3.1), [DISPLAY TT TRACK] or [DISPLAY GPS BUOY TRACK]. For other ship's symbols, select [DISPLAY AIS SYMBOLS], [DISPLAY TT SYMBOLS] or [DISPLAY GPS BUOY SYMBOLS].

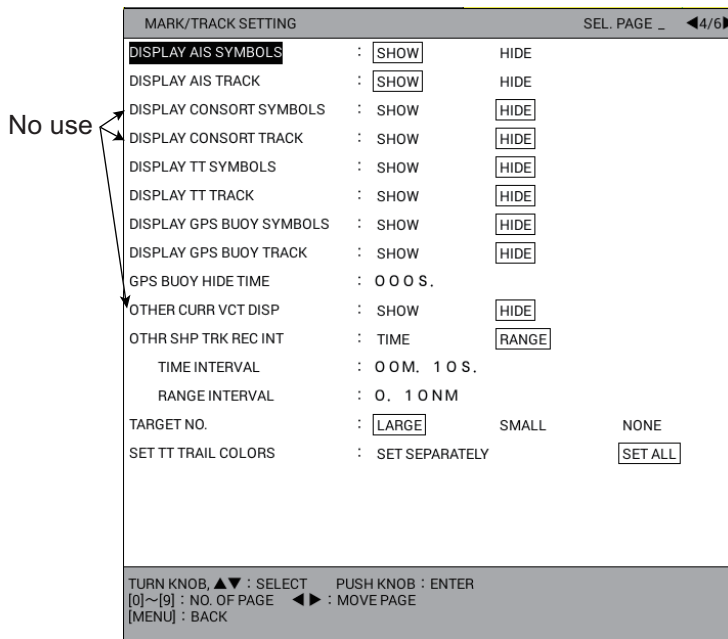

4. Select [SHOW] to show each track or symbol, or [HIDE] to hide each track or symbol.
5. Press the **DISP** key to close the menu.

3.1.3 How to show/hide the current vector

The current vector can be displayed at every memory point on own ship track.

1. Press the **MENU** key to open the main menu.
2. Select [4. MARK/TRACK SETTING].
3. Go to page 2, then select [DISP. CURRENT VECTOR].
4. Select [SHOW] to show current vector on own ship, or [HIDE] to hide the current vector.
5. Press the **DISP** key to close the menu.

Note: The current vector can be displayed on own ship mark. See [OS CURR. VECTOR DISP] on page 9-15.

3.1.4 How to show/hide drift vector

The drift vector (see "Simple calculation function for drift" on page 3-17) can be displayed at every memory point on own ship track.

1. Press the **MENU** key to open the main menu.
2. Select [4. MARK/TRACK SETTING].
3. Select [DRIFT VECTOR DISPLAY] on page 2.
4. Select [SHOW] to show drift vector on own ship track or [HIDE] to hide drift vector.
5. Press the **DISP** key to close the menu.



Note: The drift vector can be displayed on own ship mark. See [DISPLAY OS DRIFT VECTOR] on page 9-15.

3.2 How to Record Own Ship's Track

3.2.1 How to stop/restart recording of track

When your boat is at anchor or returning to port, you probably won't need to record its track. You can stop recording the track, to conserve the track memory, as follows.

1. Press the **PLOT INTVL** key consecutively so the track plotting interval icon at the bottom of the screen shows  (hold) to stop recording the track. Each press of the key selects the track interval or stops track plotting as follows:

Track interval 1 () → Track interval 2 () → Stop of track plotting () → Track interval 1 → ...

When selecting [OWN TRACK PLOTTING INTERVAL] in the [DISPLAY SETTING] menu as the navigation/destination information, the current track interval is displayed in the NAV information box (see section 1.4.2). When track plotting is stopped, the own ship mark changes from ● to ○, and the track is not stored in the memory.

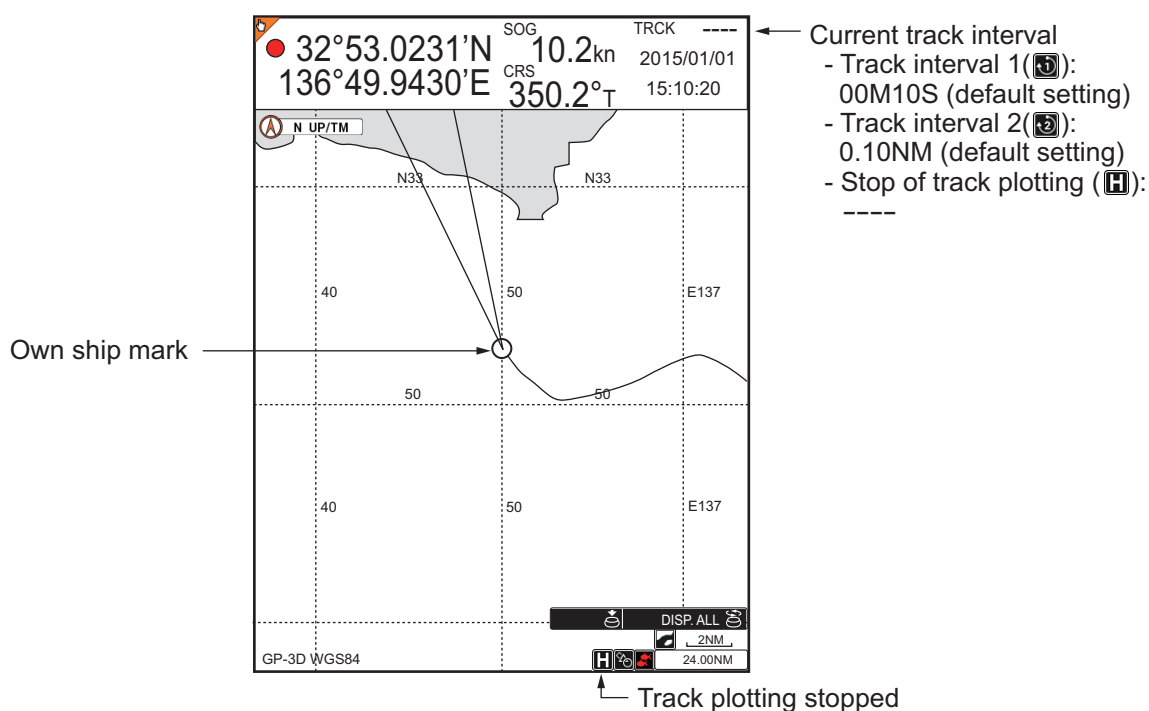

3. TRACK

- To restart recording, press the **PLOT INTVL** key. The own ship mark changes from ○ to ●.

Note: Recording can also be stopped or restarted from the echo sounder display.

3.2.2 How to show track while track plotting is stopped

You can show or hide own ship track on the plotter display while track plotting is stopped.

- Press the **MENU** key to open the main menu.
- Select [4. MARK/TRACK SETTING].
- Select [DISP. STOPPED TRACKS] on page 2.
- Select [SHOW] or [HIDE].

[SHOW]: The own ship track is shown while track plotting is stopped. The own ship track is not recorded; the track is erased when it goes off screen or when the power is turned off. Also, the own ship track whose plotting is stopped is erased when its plotting is restarted or when the chart display is zoomed in or out, as shown in the right figure.

[HIDE]: The own ship track is not displayed while track plotting is stopped.

- Press the **DISP** key to close the menu.

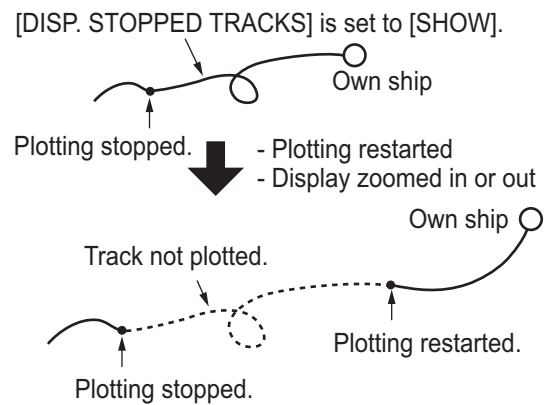

3.2.3 How to connect track after restarting plotting

When you restart plotting of track, the points where the plotting was stopped and restarted can be connected with a straight line. Also, you can set the track plotting interval for time while plotting is paused.

- Press the **MENU** key to open the main menu.
- Select [4. MARK/TRACK SETTING].
- Select [PLOT STOPPED TRACKS] on page 2.
- Select [DRAW TRACK LINE] or [NO TRACK LINE].

[DRAW TRACK LINE]: Stopping and restarting points are connected with a straight line.

[NO TRACK LINE]: Stopping and restarting points are not connected.

- Select [TRACK INTERVAL WHILE RECORDING IS PAUSED]
- Select desired interval.
- Press the **DISP** key to close the menu.

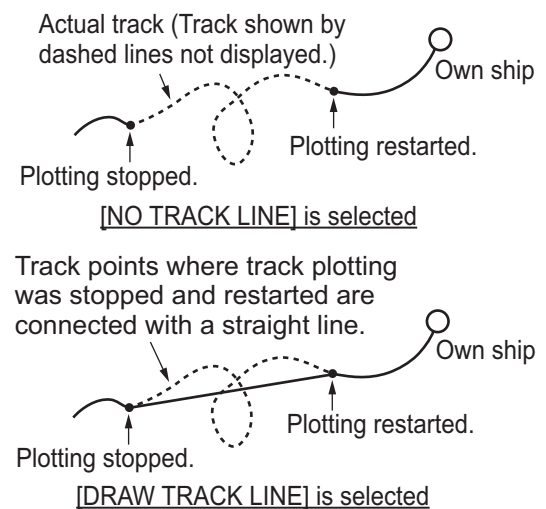

3.3 How to Change Track Color

Track color is available in red, yellow, green, light-blue, purple, blue, or white. It can be useful to change track color on a regular basis to discriminate between previous day's track, etc. The track color for own ship can be changed automatically according to water temperature or depth.

3.3.1 How to change track color for own ship

1. Press the **TRACK COLOR** key to show the [CHANGE TRACK COLOR] window.

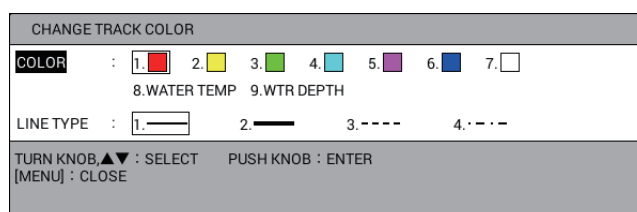

Note: This window automatically closes when there is no operation for 10 seconds.

2. Select [COLOR].
3. Press the applicable numeric key to select the color. The color changes at the moment a key is pressed.
 - 1 to 7:** Track is colored according to the color shown on the numeric key pressed.
 - 8 [WATER TEMP]:** Track color changes with water temperature. (Requires water temperature sensor.)
 - 9 [WTR DEPTH]:** Track color changes with depth.
4. Press the **MENU** or **DISP** key to close the window.

Note: You can partly change track color in the [EDIT TRACK] menu (see section 3.7).

3.3.2 How to automatically change track color for own ship with water temperature

The track color for own ship changes with water temperature when selecting [8. WATER TEMP] at step 3 in section 3.3.1. There are two methods by which track color may be changed according to water temperature: by preset temperature range or temperature variation.

How to change track color by preset temperature range

The own ship track is displayed in the same color when the water temperature is within a preset range. For example, you can set up to paint the track yellow when the water temperature is between 63°F and 68°F.

1. Press the **MENU** key to open the main menu.
2. Select [4. MARK/TRACK SETTING].

3. TRACK

3. Select [TRACK COLOR BY TEMP.] on page 3.

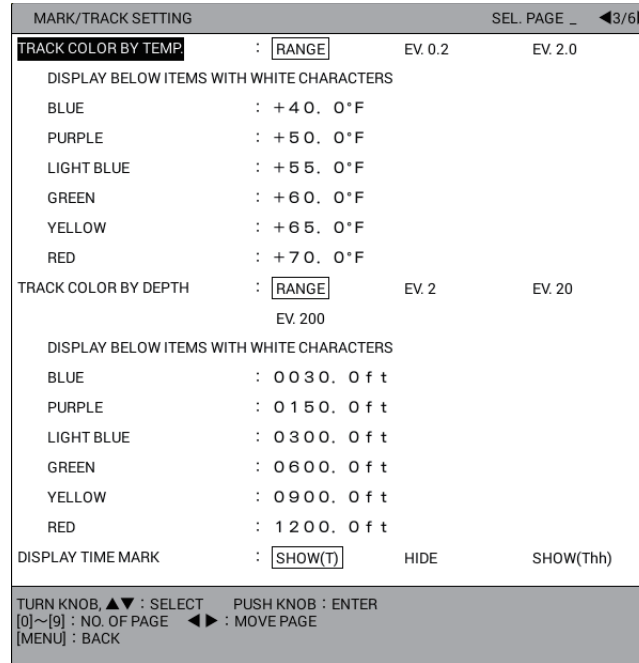

4. Select [RANGE].
5. Set the temperature range desired for each color. For example, to paint the track red when the water temperature is higher than 68°F, do the following:
 - 1) Select [RED].
 - 2) Press the **6, 8, 0** keys.
 - 3) Set ranges for other colors similarly.
 - Note 1:** The temperature range should be set in ascending order from BLUE.
 - Note 2:** The temperature less than the one set at BLUE is displayed in WHITE.
6. Press the **DISP** key to close the menu.

How to change track color by temperature variation

This setting paints the track in up to five colors according to temperature variation selected. The setting [EV. 0.2], for example, paints the track red when the water temperature is between 65.0°F and 65.1°F; yellow when the water temperature is between 65.2°F and 65.3°F. Thus, the track color changes green, light-blue and purple in 0.2 degree steps. When the water temperature becomes 66.0°F, the track color returns to red (see the figure below).

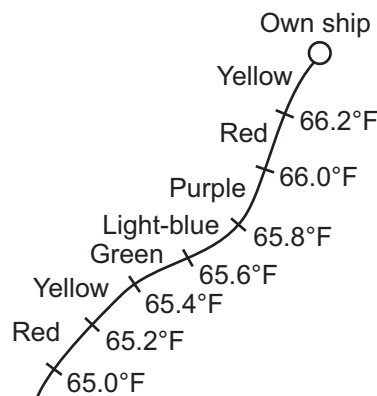

1. Press the **MENU** key to open the main menu.

2. Select [4. MARK/TRACK SETTING].
3. Select [TRACK COLOR BY TEMP.] on page 3.
4. Select [EV. 0.2] or [EV. 2.0].
5. Press the **DISP** key to close the menu.

3.3.3 How to automatically change track color for own ship with depth

The track color for own ship changes with depth when selecting [9. WTR DEPTH] at step 3 in section 3.3.1. There are two methods by which track color may be changed according to depth: by preset depth range or depth variation.

How to change track color by preset depth range

The own ship track is displayed in the same color when the depth is within a preset range. For example, you can set up to paint the track yellow when the depth is between 500 and 600 ft.

1. Press the **MENU** key to open the main menu.
2. Select [4. MARK/TRACK SETTING].
3. Select [TRACK COLOR BY DEPTH] on page 3.
4. Select [RANGE].
5. Set the depth range as desired. For example, to change track color to red when the depth is more than 1000 ft, do the following:
 - 1) Select [RED].
 - 2) Press the **1, 0, 0, 0, 0** keys.
 - 3) Set depths for other colors similarly.

Note 1: The depth should be set in ascending order from BLUE.

Note 2: The depth less than the one set at BLUE is displayed in WHITE.
6. Press the **DISP** key to close the menu.

How to change track color by depth variation

This setting paints the track in up to five colors according to depth variation selected. The setting [EV. 2], for example, paints the track red when the depth is between 600 and 602 ft; yellow when the depth is between 603 and 604 ft. Thus, the track color changes green, light-blue and purple in 2 ft steps. When the depth becomes 610 ft, the track color returns to red (see the figure below).

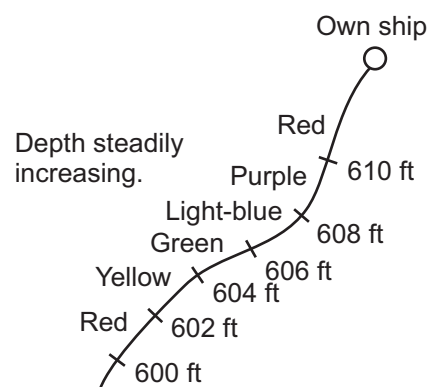

1. Press the **MENU** key to open the main menu.
2. Select [4. MARK/TRACK SETTING].
3. Select [TRACK COLOR BY DEPTH] on page 3.
4. Select [EV. 2], [EV. 20] or [EV. 200].
5. Press the **DISP** key to close the menu.

3.3.4 How to collectively change track color for other ship

Note: Only for TT symbols, select [SET ALL] in [SET TT TRAIL COLORS] on page 4 of the [MARK/TRACK SETTING] menu first.

1. Put the cursor on the target symbol to change its track color. The selected target data (see section 3.9) is displayed.
2. While the selected target data is displayed, press the **TRACK COLOR** key to show the [CHANGE TRACK COLOR] window. The following figure is the example for TT symbol.

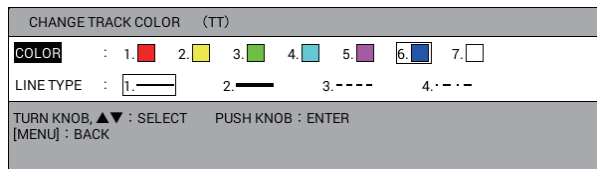

Note: The [CHANGE TRACK COLOR] window closes automatically when there is no operation for 10 seconds.

3. Select [COLOR].
4. Press the numeric key corresponding to desired color. The color changes at the moment a key is pressed.
5. Press the **MENU** or **DISP** key to close the window.

3.3.5 How to separately change track color for TT symbol

Note 1: Connect only one radar. If you set TT on multiple radars, the track color and line type for TT symbol are not be set correctly.

Note 2: Select [SET SEPARATELY] in [SET TT TRAIL COLORS] on page 4 of the [MARK/TRACK SETTING] menu first.

1. Put the cursor on the TT symbol to change its track color. The selected target data (see section 3.9) is displayed.
2. While the selected target data is displayed, press the **TRACK COLOR** key to show the [CHANGE TRACK COLOR (TTxxx)] window (xxx: target number (1 to 100)).

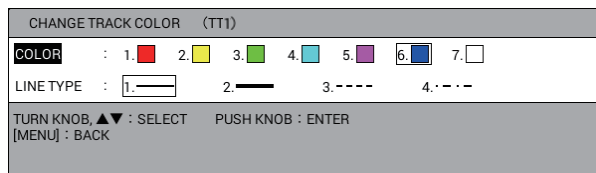

Note: The [CHANGE TRACK COLOR (TTxxx)] window closes automatically when there is no operation for 10 seconds.

3. Select [COLOR].
4. Press the numeric key corresponding to desired color. The color changes at the moment a key is pressed.
5. Press the **MENU** or **DISP** key to close the window.

3.4 How to Change Track Line Type

Track may be traced on the display with a thin solid line (—), thick solid line (———), dotted line (----), or dot-dash line (-.-).

3.4.1 How to change track line type for own ship

1. Press the **TRACK COLOR** key to show the [CHANGE TRACK COLOR] window.

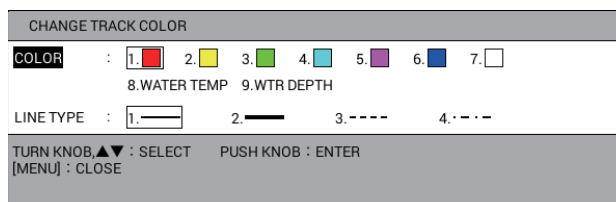

Note: The [CHANGE TRACK COLOR] window closes automatically when there is no operation for 10 seconds.

2. Select [LINE TYPE].
3. Press the numeric key corresponding to desired line type. The line type changes at the moment a key is pressed.
4. Press the **MENU** or **DISP** key to close the window.

Note: You can partly change track line type in the [EDIT TRACK] menu (see section 3.7).

3.4.2 How to collectively change track line type for other ship

Note: Only for TT symbols, select [SET ALL] in [SET TT TRAIL COLORS] on page 4 of the [MARK/TRACK SETTING] menu first.

1. Put the cursor on the target symbol to change its track line type. The selected target data (see section 3.9) is displayed.
2. While the selected target data is displayed, press the **TRACK COLOR** key to show the [CHANGE TRACK COLOR] window. The following figure is the example for TT symbol.

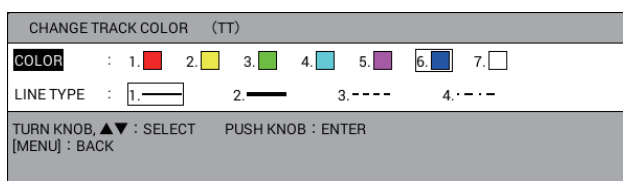

Note: The [CHANGE TRACK COLOR] window closes automatically when there is no operation for 10 seconds.

3. Select [LINE TYPE].
4. Press the numeric key corresponding to desired line type. The line type changes at the moment a key is pressed.
5. Press the **MENU** or **DISP** key to close the window.

3.4.3 How to separately change track line type for TT symbol

Note 1: Connect only one radar. If you set TT on multiple radars, the track color and line type for TT symbol are not be set correctly.

Note 2: Select [SET SEPARATELY] in [SET TT TRAIL COLORS] on page 4 of the [MARK/TRACK SETTING] menu first.

1. Put the cursor on the TT symbol to change its track line type. The selected target data (see section 3.9) is displayed.
2. While the selected target data is displayed, press the **TRACK COLOR** key to show the [CHANGE TRACK COLOR (TTxxx)] window (xxx: target number (1 to 100)).

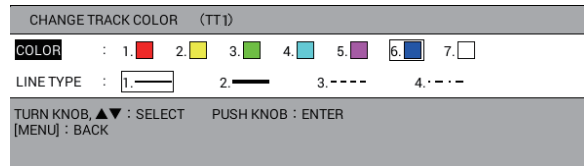

Note: The [CHANGE TRACK COLOR (TTxxx)] window closes automatically when there is no operation for 10 seconds.

3. Select [LINE TYPE].
4. Press the numeric key corresponding to desired line type. The line type changes at the moment a key is pressed.
5. Press the **MENU** or **DISP** key to close the window.

3.5 How to Select Track Plotting Method, Interval

In drawing the track for own ship or other ship, position is stored into the unit's memory at an interval of time or distance. A shorter interval provides better reconstruction of the track, but the storage time of the track is reduced. When the track memory becomes full, the oldest track is erased to make room for the latest.

3.5.1 How to select the track plotting method for own ship

The own ship track is traced at an interval of time or distance. The default settings are 10 seconds for track interval 1, 0.1 NM for track interval 2.

Press the **PLOT INTVL** key consecutively to select the track plotting method. Each press of the key selects the track interval or stops track plotting as follows:
Track interval 1 → Track interval 2 → Stop of track plotting → Track interval 1 → ...
When selecting [OWN TRACK PLOTTING INTERVAL] in the [DISPLAY SETTING] menu as the navigation/destination information, the current track interval is displayed in the NAV information box (see section 1.4.2). Distance is useful for conserving the track memory, since no track is recorded when the vessel is stationary.

For how to set the track plotting intervals, see section 3.5.2.

3.5.2 How to set the track plotting intervals for own ship

1. Press the **MENU** key to open the main menu.
2. Select [4. MARK/TRACK SETTING].
3. Select [TRACK INTERVAL 1] or [TRACK INTERVAL 2] on page 1.

4. Select [TIME] or [RANGE].
5. Select [TIME INTERVAL] or [RANGE INTERVAL].
6. Press the numeric keys to enter time or range value. The setting range is 00M. 00S. to 99M. 59S. for time; 0.00 NM to 9.99 NM for range. When set [TIME INTERVAL] and [RANGE INTERVAL] to 0, the track is traced at intervals of 1 second.
7. Press the **DISP** key to close the menu.

3.5.3 How to set the track plotting intervals for other ship

1. Press the **MENU** key to open the main menu.
2. Select [4. MARK/TRACK SETTING].
3. Go to page 4, then select [OTHR SHP TRK REC INT].

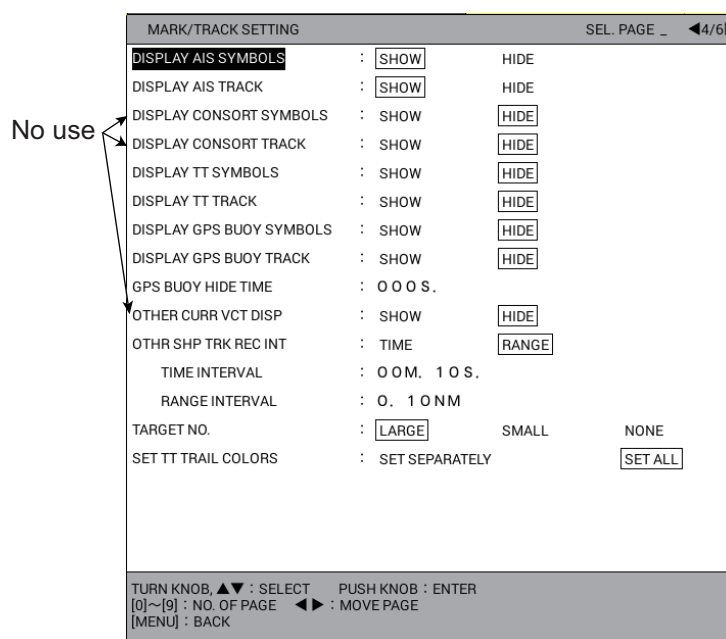

4. Select [TIME] or [RANGE].
5. Select [TIME INTERVAL] or [RANGE INTERVAL].
6. Press the numeric keys to enter time or range value. The setting range is 00M. 00S. to 99M. 59S. for time; 0.00 NM to 9.99 NM for range. When set [TIME INTERVAL] and [RANGE INTERVAL] to 0, the track is traced at intervals of 1 second.
7. Press the **DISP** key to close the menu.

3.6 How to Erase Own Ship Track

You can erase own ship track by color or by line type. There are five methods to select the erasing range as follows:

- [1. BTWN 2PTS.]: Erases all tracks between two points entered on the plotter display.
- [2. SET RNG]: Erases tracks, in selected color and line type, within an area you set.
- [3. WITHIN RNG]: Erases tracks, in selected color and line type, currently shown on the screen.

3. TRACK

- [4.OUT OF RNG]: Erases tracks, in selected color and line type, currently not shown on the screen.
- [5. ALL]: Erases tracks, in selected color and line type, in the internal memory.

Note 1: The erased tracks cannot be restored.

Note 2: The tracks in the internal memory that are set to [YES] on [DISPLAY OWN TRACK] in the [DISPLAY INTERNAL MEMORY] menu cannot be erased.

Note 3: If the track is being automatically colored according to depth or water temperature, and the color in use just before selecting [8. WATER TEMP] or [9. WTR DEPTH] is chosen for erasure, all depth- (or water temperature-) colored track from that point to the time of erasure will also be erased (see section 3.3.1).

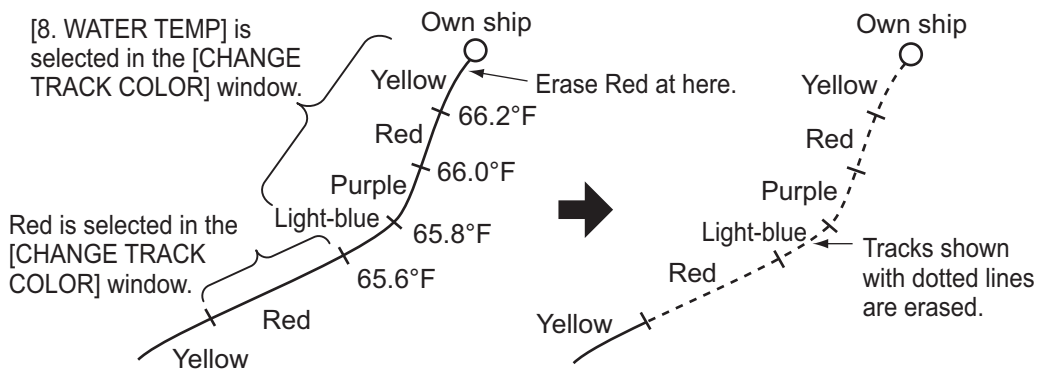

1. Press the **MENU** key to open the main menu.
2. Select [5. MARK/TRACK EDIT/DELETE].

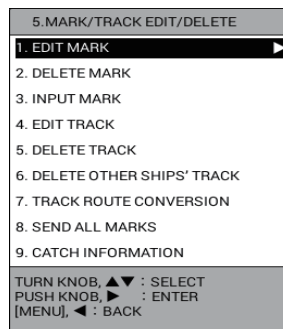

3. Select [5. DELETE TRACK].

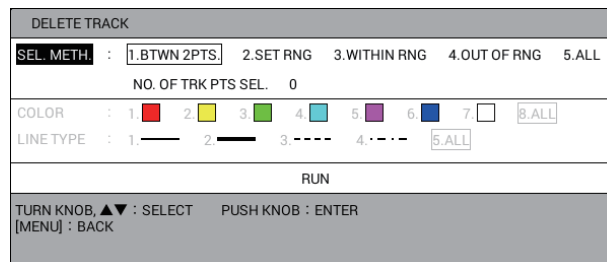

4. Select [SEL. METH.]
5. Press the applicable numeric key to select the method for erasing range. For [1. BTWN 2PTS.] or [2. SET RNG], go to step 6. For [3. WITHIN RNG], [4. OUT OF RNG], or [5.ALL], go to step 7.

6. Do one of the following:
Squares (memory points) appear on the track.

- [1. BTWN 2PTS.]: Select the starting memory point to erase. Then select the ending memory point to erase. The tracks between two points are erased. Go to step 12.

Note: Both current track and playback track cannot be erased at the same time.

- [2. SET RNG]: Select the starting point of the area to erase. Then select the ending point of the area to erase. The selected area is framed in a white triangle with gray border. Go to step 7.

7. Select [COLOR].

8. Press the applicable numeric key to select the color to erase. Select [8. ALL] to erase tracks of all colors within the area you set.

9. Select [LINE TYPE].

10. Press the applicable numeric key to select the line type to erase. Select [5. ALL] to erase tracks of all line types within the area you set. The number of memory points selected for erasure is displayed in [NO. OF TRK PTS SEL.].

11. Select [RUN] to erase the own ship track you set.

12. Press the **DISP** key to close the menu.

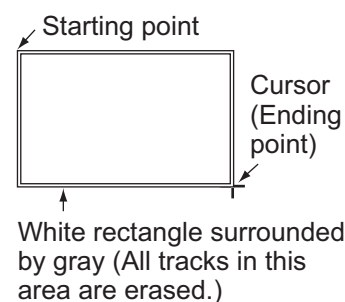
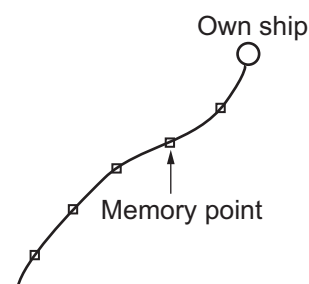

3.7 How to Edit Own Ship Track

The color and line type of own ship track can be changed. For example, you may want to change the color and line of the track after returning to port, to distinguish previous and current track. Four methods of selecting range to edit are available:

- [1. BTWN 2PTS.]: Edits all tracks between two points entered on the plotter display. Both current track and playback track cannot be edited at the same time.
- [2. SET RNG]: Edits tracks within an area you set.
- [3. WITHIN RNG]: Edits tracks currently shown on the screen.
- [4. OUT OF RNG]: Edits tracks currently not shown on the screen.

Note 1: The tracks in the internal memory, set to [YES] on [DISPLAY OWN TRACK] in the [DISPLAY INTERNAL MEMORY] menu, cannot be edited.

Note 2: If the tracks are being automatically colored according to depth or water temperature, the tracks cannot be edited (see section 3.3.1).

1. Press the **MENU** key to open the main menu.
2. Select [5. MARK/ TRACK EDIT/DELETE].

3. TRACK

3. Select [4. EDIT TRACK].

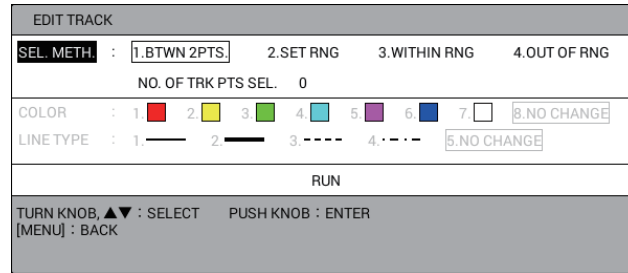

4. Select [SEL. METH.].
5. Press the applicable numeric key to select the method for editing range. For [1. BTWN 2PTS.] or [2. SET RNG], go to step 6. For [3. WITHIN RNG] or [4. OUT OF RNG], go to step 7.
6. Do one of the following:
Squares (memory points) appear on the track.
 - [1. BTWN 2PTS.]: Select the starting memory point to edit. Then select the ending memory point to edit.
 - [2. SET RNG]: Select the starting point of the area to edit. Then select the ending point of the area to edit.
7. Select [COLOR].
8. Press the applicable numeric key to select the new color. Select [8. NO CHANGE] to keep the color.
9. Select [LINE TYPE].
10. Press the applicable numeric key to select the new line type. Select [5. NO CHANGE] to keep the line type. The number of memory points selected for editing is displayed in [NO. OF TRK PTS SEL.].
11. Select [RUN] to edit the own ship track you set.
12. Press the **DISP** key to close the menu.

3.8 How to Display Own Ship Information

3.8.1 Simple information

1. Press the **CURSOR ON/OFF** key to turn on the cursor.
2. Put the cursor on the own ship mark to display the simple information.

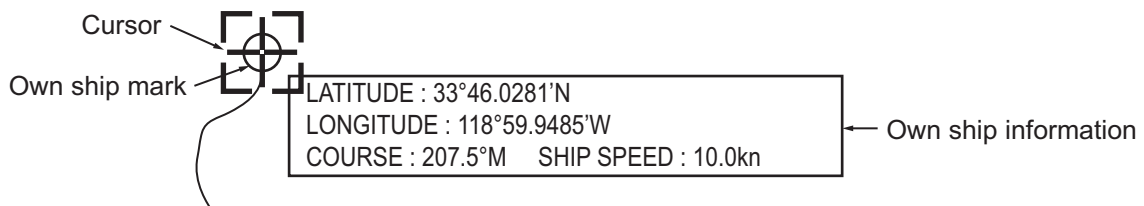

Note: If the own ship information does not appear when putting the cursor on the own ship mark, do the following:

- 1) Press the **MENU** key to open the main menu.
- 2) Select [0. SYSTEM SETTING].

- 3) Select [1. DISPLAY FORMAT].
- 4) Select [DISPLAY OWN SHIP] on page 5.
- 5) Select [SHOW].
- 6) Press the **DISP** key to close the menu.

3.8.2 Detailed information

1. Press the **CURSOR ON/OFF** key to turn on the cursor.
2. Put the cursor on the own ship mark then push the **ENTER** knob to display the detailed information.

“- -” is displayed when no data is input.

When the current data is input from the external equipment, its data is displayed here.

SHIP INFO			
POSITION	: 33° 45.8365'N, 119° 00.0598'W		
COURSE	: 207.7°M	SHIP SPEED	: 10.0kn
DRIFT	:	2.0kn	207.7°M
CURRENT1	: LVR 1	--,-kn	--,-°M
CURRENT2	: LVR 2	--,-kn	--,-°M
CURRENT3	: LVR 3	--,-kn	--,-°M
[MENU] : BACK			

The current direction and speed for each layer are displayed in [CURRENT1] to [CURRENT3]. The current direction and speed are set in [CURRENT DISPLAY 1] to [CURRENT DISPLAY 3] on page 5 of the [DISPLAY FORMAT] menu (see page 9-15). When the current data is input from the external equipment, its data is displayed. When [OS CURR. VECTOR DISP] on page 5 in the [DISPLAY FORMAT] menu is set to [SHOW], the current vector is displayed on the own ship mark on the plotter display. This is useful to see the deviation between set course and heading affected by current or wind.

Simple calculation function for drift

When no current data is input from the external equipment, drift is calculated using the data of COG (course over the ground) and STW* (speed through the water). The calculated drift is displayed in [DRIFT]. When [DISPLAY OS DRIFT VECTOR] on page 5 in the [DISPLAY FORMAT] menu is set to [SHOW], the drift vector is displayed on the own ship mark on the plotter display (see page 9-15).
*: Required data from external equipment or optional speed/temperature sensor.

Note: If [DRIFT/CURR. VCTR DISPLAY] ([SYSTEM SETTING] menu, [DISPLAY FORMAT] menu page 5) is set to [FROM], the drift/current display is shifted 180°.

3. Press the **MENU** or **DISP** key to close the [SHIP INFO] window.

3.9 How to Display Other Ship Information

You can display the information for other ship (AIS, TT, GPS BUOY).

How to display information individually

1. Press the **CURSOR ON/OFF** key to turn on the cursor.
2. Put the cursor on the target symbol of other ship track to display the information. The following figure shows the TT information. “- -” is displayed when no data is input.

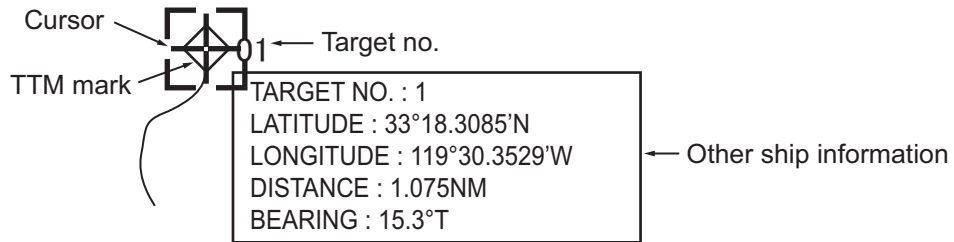

Note: If other ship information does not appear when putting the cursor on the target symbol, do the following:

- 1) Press the **MENU** key to open the main menu.
- 2) Select [0. SYSTEM SETTING].
- 3) Select [1. DISPLAY FORMAT].
- 4) Select [OTHR SHIP INFO DISP.] on page 5.
- 5) Select [SHOW].
- 6) Press the **DISP** key to close the menu.

How to display the GPS buoy list

The GPS buoy list shows all the GPS buoys in your area. You can show the list as follows:

1. Press the **MENU** key to open the main menu.
2. Select [2. OTHER SHIPS LIST].
3. Select [4. GPS BUOY LIST] to display the GPS buoy list.

GPS BUOY LIST				SEL. PAGE	1/2▶
ID	POSITION	DISTANCE	BEARING		
1	33° 52.7025'N, 118° 55.1781' W	0.140NM	47.0°M		
2	33° 52.6400'N, 118° 55.1262'W	0.164NM	74.5°M		
3	33° 52.5775'N, 118° 55.0743'W	0.214NM	92.2°M		
4	33° 52.5150'N, 118° 55.0224'W	0.276NM	102.6°M		
5	33° 52.4525'N, 118° 54.9705'W	0.344NM	109.0°M		
6	33° 52.3900'N, 118° 54.9186'W	0.414NM	113.3°M		
7	33° 52.3275'N, 118° 54.8667'W	0.486NM	116.4°M		
8	33° 52.2650'N, 118° 54.8149'W	0.560NM	118.6°M		
9	33° 52.2025'N, 118° 54.7629'W	0.634NM	120.3°M		
10	33° 52.1400'N, 118° 54.7110'W	0.708NM	121.7°M		

[CENTER] : CENTER TARGET
 PUSH KNOB : SHOW DETAILS [TRACK COLOR] : CHANGE COLOR
 [PLOT INTVL] : RECORD START/STOP [MENU] : BACK

When [TARGET SMART TRACK] is set to [ON], this indication changes as below (see page 9-15).

[CENTER] : SMART TRACK SELECTED TARGET

- ◀, ▶: Shifts the page.
- ▲, ▼, or rotation of the **ENTER** knob: Selects a GPS buoy.

- **CENTER** key: Centers the selected GPS buoy on the plotter display. When [TARGET SMART TRACK] is set to [ON] (see page 9-15) and [DISPLAY GPS BUOY SYMBOLS] is set to [SHOW] (see section 3.1.2), each press of the key centers the GPS buoy or own ship on the plotter display. For the GPS buoy, the indication as shown in the right figure appears at the top left of the screen.

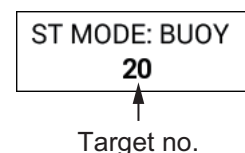

Note: The orientation mode can not be changed during OS (other ship) mode.

- Pushing of the **ENTER** knob: Displays the detailed information for the selected GPS buoy.

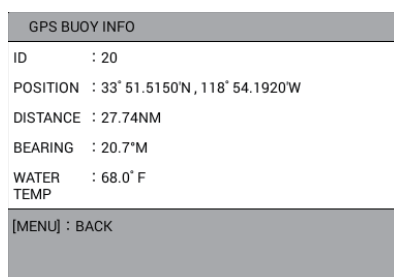

Note 1: You can display the detailed information by putting the cursor on the GPS buoy symbol then pushing the **ENTER** knob.

Note 2: If [DRIFT/CURR. VCTR DISPLAY] ([SYSTEM SETTING] menu, [DISPLAY FORMAT] menu page 5) is set to [FROM], the drift/current display is shifted 180°.

- **TRACK COLOR** key: Displays the [CHANGE TRACK COLOR ID (XX)] window. Change the color and line type for the selected GPS buoy (see section 3.3 and section 3.4).

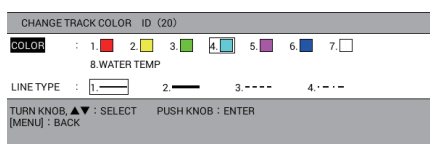

- **PLOT INTVL** key: Stops or restarts recording of track for the selected GPS buoy.

4. Press the **DISP** key to close the GPS buoy list and the menu.

GPS buoy timeout

If the GPS buoy data cannot be received for a certain period of time, the GPS buoy becomes lost. You can set that time as follows.

1. Press the **MENU** key to open the main menu.
2. Select [4. MARK/TRACK SETTING].
3. Go to page 4, then select [GPS BUOY HIDE TIME].
4. Use the numeric keys to set a time, from 0 to 999 seconds. "0" sets no timeout.
5. Press the **DISP** key to close the menu.

A lost GPS buoy disappears from the screen and the GPS buoy list.

3.10 How to Change the Size of the Target Number

You can change the size of the target number displayed beside the target symbol.

1. Press the **MENU** key to open the main menu.
2. Select [4. MARK/TRACK SETTING].
3. Select [TARGET NO.] on page 4.

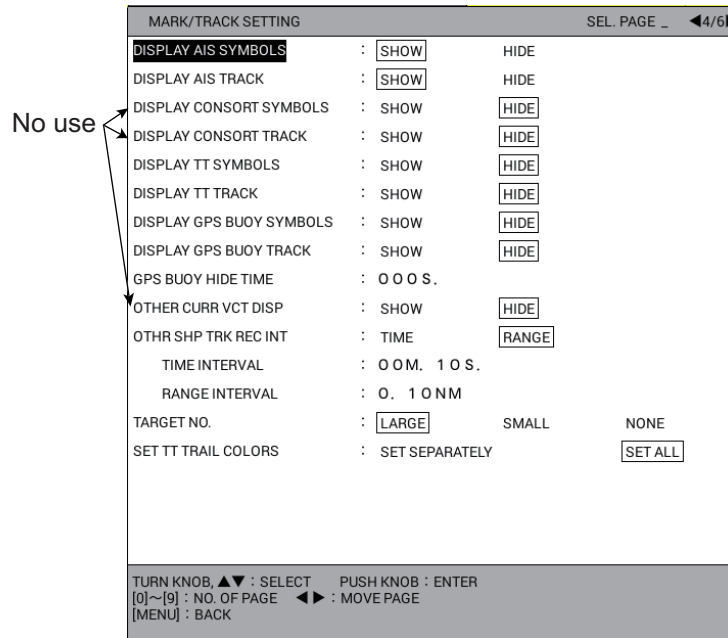

4. Select [LARGE], [SMALL], or [NONE]. [NONE] displays no target numbers.
5. Press the **DISP** key to close the menu.

3.11 How to Erase Other Ship Track

To erase other ship track, do the following:

1. Press the **MENU** key to open the main menu.
2. Select [5. MARK/TRACK EDIT/DELETE].
3. Select [6. DELETE OTHER SHIPS' TRACK].

DELETE OTHER SHIPS' TRACK	
SEL. METH :	1.SPECIFY TARGET 2.ALL
NO. OF TRK PTS SEL. 0	
COLOR :	1 ■ 2 ■ 3 ■ 4 ■ 5 ■ 6 ■ 7 8.ALL
LINE TYPE :	1 2 3 4 5.ALL
RUN	
TURN KNOB, ▲▼ : SELECT PUSH KNOB : ENTER	
[MENU] : BACK	

4. Select [SEL. METH.].
5. Press the applicable numeric key to select the erasure method.
 - [1. SPECIFY TARGET]: Erases tracks for the selected target. Go to step 6.
 - [2. ALL]: Erases tracks in the color selected at step 8 and the line type selected at step 10 among all recorded tracks for other ships. Go to step 7.
6. For [1. SPECIFY TARGET], select a track point for the target to erase.
7. Select [COLOR].
8. Press the applicable numeric key to select the color to erase. Select [8. ALL] to erase tracks of all colors within the area you set.
9. Select [LINE TYPE].
10. Press the applicable numeric key to select the line type to erase. Select [5. ALL] to erase tracks of all line types within the area you set. The number of track points selected for erasure is displayed in [NO. OF TRK PTS SEL.].
11. Select [RUN] to erase the tracks.
12. Press the **DISP** key to close the menu.

3. TRACK

This page is intentionally left blank.

4. MARKS, LINES

Marks are useful for denoting important points such as a good fishing spot. 30,000 marks can be entered. Marks can be inscribed in 12 shapes or with a numeral, and seven colors. Marks can be connected with lines.

Marks can be entered from the echo sounder display.

4.1 How to Set Default Mark Appearance

Before you enter a mark, you can set its color, size, fish type and line type.

4.1.1 How to set mark color

Marks can be inscribed in seven colors of red, yellow, green, light-blue, purple, blue and white.

1. Press the **MARK COLOR** key to show the [CHANGE MARK COLOR] window.

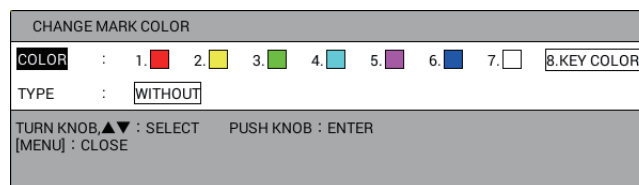

Note: This window automatically closes when there is no operation for 10 seconds.

2. Select [COLOR].
3. Press the applicable numeric key to select the color.
1 to 7: The mark or line is entered at own ship's position (or cursor position) in the color selected.
8: The mark is entered at own ship's position (or cursor position) in the color and shape (number or symbol) shown on the label of the numeric key.
4. Press the **MENU** or **DISP** key to close the window.

4. MARKS, LINES

4.1.2 How to set mark size

You can select the mark size as follows:

1. Press the **MENU** key to open the main menu.
2. Select [4. MARK/TRACK SETTING].
3. Select [MARK SIZE] on page 1.

MARK/TRACK SETTING		SEL. PAGE _ 1/6▶
MARK SIZE	: [LARGE]	LARGE WITH DOT
		SMALL
SHOW MARK COMMENTS	: ON CHART	IN POPUP
		[IN INFORMATION]
NUMBER OF RUN DATA MARKS TO DISPLAY	: [DEFAULT]	MAXIMUM NUMBER OF MARKS
DISPLAY OF DUPLICATE RUN DATA MARKS	: [UNLIMITED]	LIMITED
DISPLAY DUPLICATE INTERNAL MARKS	: [UNLIMITED]	LIMITED
LINE TYPE	: — [---] - - - -	
AUTO RECORD SETTING	: [SCREEN SHOT WHEN MARK INPUT]	
		NO
TRACK INTERVAL 1	: [TIME]	RANGE
TIME INTERVAL	: 0 0 M. 1 0 S. (MAX 3D11H)	
RANGE INTERVAL	: 0. 1 0 N M	
TRACK INTERVAL 2	: TIME	[RANGE]
TIME INTERVAL	: 0 0 M. 1 0 S. (MAX 3D11H)	
RANGE INTERVAL	: 0. 1 0 N M	
TURN KNOB, ▲▼ : SELECT PUSH KNOB : ENTER		
[0]~[9] : NO. OF PAGE ◀▶ : MOVE PAGE		
[MENU] : BACK		

4. Select the mark size.

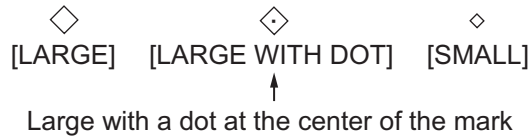

5. Press the **DISP** key to close the menu.

The size for currently displayed marks is changed to the size selected here.

4.1.3 How to set line type

There are four line types.

1. Press the **MENU** key to open the main menu.
2. Select [4. MARK/TRACK SETTING].
3. Select [LINE TYPE] on page 1.
4. Select the line type.



5. Press the **DISP** key to close the menu.

The lines entered hereafter are displayed in the line type selected here.

4.1.4 How to set fish type for marks

Fish type can be assigned to marks. Marks can be shown or hidden depending on fish type with the mark filter function (see section 4.9).

1. Press the **MARK COLOR** key to show the [CHANGE MARK COLOR] window.

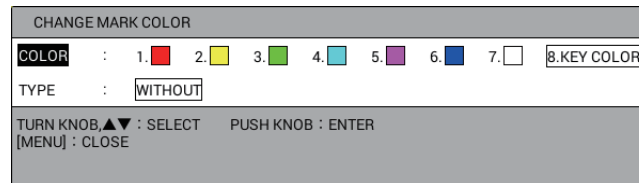

Note: This window automatically closes when there is no operation for 10 seconds.

2. Select [TYPE]. See section 4.9 how to enter fish type.

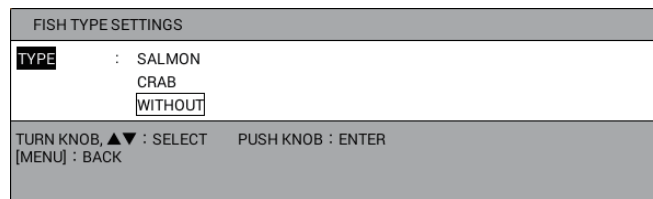

3. Select [TYPE] again.
4. Select the fish type. [WITHOUT] does not set a fish type.
5. Press the **MENU** or **DISP** key to close the window.

The marks entered hereafter are set to the fish type selected here.

4.2 How to Enter Marks

There are three methods to enter marks as follows:

- Enter a mark at own ship position.
- Enter a mark at the cursor position.
- Enter a mark by manually entering latitude and longitude position.

Note: A mark can be entered with the symbol or the numeric labeled on the operated numeric key. Select the entry method with the **MARK/NUM** key, before entering the mark.

4.2.1 How to enter marks at own ship position

1. Press the **CURSOR ON/OFF** key to turn off the cursor.
2. Press a numeric key among **1** to **8**.

1 key: ◇	2 key: +	3 key: □	4 key: Y
5 key: ○	6 key: △	7 key: ·	8 key: ☆

The mark (or numeric) labeled on the operated key appears at own ship position. Marks are displayed in the color set in section 4.1.1. Water temperature and depth at the location are saved internally. (Requires water temperature and depth data.)

4. MARKS, LINES

Note: When the item selected in section 4.1.1 is [8. KEY COLOR], the mark is entered in the same color as the most recently entered mark. If, after startup, the **8** key is operated the mark will be colored red.

4.2.2 How to enter marks at the cursor position

1. Press the **CURSOR ON/OFF** key to turn on the cursor.
2. Put the cursor on the position where you want to enter a mark.
3. Press a numeric key among **1** to **8**.

1 key: ◇ 2 key: + 3 key: □ 4 key: Y
 5 key: ○ 6 key: △ 7 key: · 8 key: ☆

The mark (or numeric) labeled on the operated key appears at the cursor position. Marks are displayed in the color set in section 4.1.1.

Note: When the item selected in section 4.1.1 is [8. KEY COLOR], the mark is entered in the same color as the most recently entered mark. If, after startup, the **8** key is operated the mark will be colored red.

4.2.3 How to enter marks by manually entering latitude and longitude position

1. Press the **MENU** key to open the main menu.
2. Select [5. MARK/TRACK EDIT/DELETE].
3. Select [3. INPUT MARK].

INPUT MARK	
LATITUDE	: 3 4 ° 4 4 . 0 0 0 0 ' N
LONGITUDE	: 1 3 5 ° 2 1 . 0 0 0 0 ' E
COLOR	: 1. ■ 2. ■ 3. ■ 4. ■ 5. ■ 6. ■ 7.
SHAPE	: 1. ◇ 2. + 3. □ 4. Y 5. ○ 6. △ 7. · 8. ☆ × ◻ ◻ ◻ ◻ 1 2 3 4 5 6 7 8 9 0
LINE TYPE	: 1. — 2. - - - - 3. · - - - 4. · · · · 5. WITHOUT
TYPE	: WITHOUT
CATCH ENT	: INPUT NO INPUT
CATCH VOL	: 0 0 0 0 0 0 0 k g
RUN	
TURN KNOB, ▲▼ : SELECT PUSH KNOB : ENTER [MENU] : BACK	

4. Select [LATITUDE].
5. Press the numeric keys to enter the latitude of the mark then push the **ENTER** knob. To switch the coordinate from North to South and vice versa, use the **CURSOR ON/OFF** key.
6. Select [LONGITUDE].
7. Press the numeric keys to enter the longitude of the mark then push the **ENTER** knob. To switch the coordinate from East to West and vice versa, use the **CURSOR ON/OFF** key. If you want to change the color, shape, fish type for mark, line type, or catch volume, select appropriate items and set the options by doing step 8 to step 18. If not, go to step 19.
8. Select [COLOR].

9. Press the applicable numeric key to select a color among red, yellow, green, light-blue, purple, blue, and white.
10. Select [SHAPE].
11. Select a shape among 12 symbols and figures of 0 to 9.

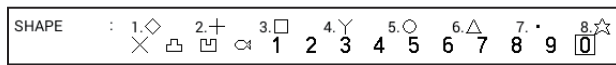

Top: Use the numeric keys to set.
Bottom: Use the **ENTER** knob to set.

12. Select [LINE TYPE].
13. Press the applicable numeric key to select a line type. When selecting 1, 2, 3 or 4, marks are connected with a line. [5. WITHOUT] does not connect marks with a line.
14. Select [TYPE]. [FISH TYPE SETTINGS] menu is shown on the screen.
15. Select [TYPE] again.
16. Select the fish type. [WITHOUT] does not set a fish type.
17. Press the **MENU** key to close the [FISH TYPE SETTINGS] menu.
18. To enter the catch volume, do the following:
 - 1) Select [CATCH ENT].
 - 2) Select [INPUT].
 - 3) Select [CATCH VOL].
 - 4) Press the numeric keys to enter the catch volume.
19. Select [RUN].
20. Press the **DISP** key to close the menu.

4.3 How to Enter Lines

Lines can be drawn on the screen to depict important locations such as fishing spots and danger areas. Lines can be connected with marks.

1. Press the **CURSOR ON/OFF** key to turn on the cursor.
2. Put the cursor on the starting point for the line then press the numeric key (1 to 8).
3. Put the cursor on an intermediate point for the line then press the **9** key.
4. Repeat step 3 to complete the line.

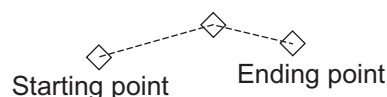

How to start a new line

To start a new line, press the numeric key (1 to 8) at the start point. For example, press one of numeric keys (1 to 8) at point D and the **9** key for points E and F.

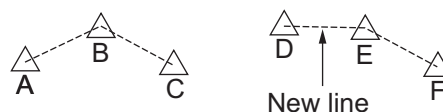

4.4 How to Erase Marks, Lines

Marks can be erased directly on the screen or from the menu, and five methods of erasure are available from the menu:

- [1. CURSOR]: Erases mark, line selected with the cursor.
- [2. SET RNG]: Erases marks and lines, in selected color, shape, and fish type, within an area you set.
- [3. WITHIN RNG]: Erases marks and lines, in selected color, shape, and fish type, currently shown on the screen.
- [4. OUT OF RNG]: Erases marks and lines, in selected color, shape, and fish type, currently not shown on the screen.
- [5. ALL]: Erases saved marks and lines, in selected color, shape, and fish type, in the internal memory.

Note: The marks in the internal memory that are set to [YES] on [ADD MARK/LINE DISP.] in the [DISPLAY INTERNAL MEMORY] menu (see section 10.2.2) cannot be erased.

How to erase individual marks, lines on the screen

1. Press the **CURSOR ON/OFF** key to turn on the cursor.
2. Put the cursor on the mark to erase. When the cursor is correctly put on the mark, a frame appears around the cursor, the one shown below. To erase a line, put the cursor on the mark on the line.



3. Press the **CANCEL** key. The selected mark is erased from the screen. If lines are connected to the mark, the lines are erased.

Note: If the mark is not erased, several marks may be occupying the same position. In this case, press the **CANCEL** key as many times as necessary to erase the mark.

How to erase marks, lines from the menu

1. Press the **MENU** key to open the main menu.
2. Select [5. MARK/TRACK EDIT/DELETE].
3. Select [2. DELETE MARK].

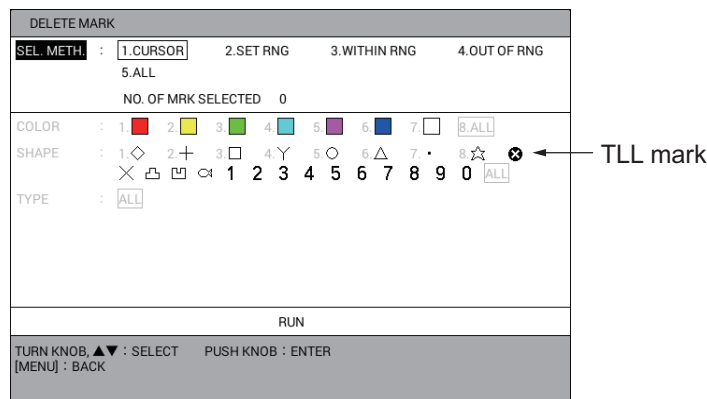

4. Select [SEL. METH.].

5. Press the applicable numeric key to select the method for erasing marks and lines. For [1. CURSOR] or [2. SET RNG], go to step 6. For [3. WITHIN RNG], [4. OUT OF RNG], or [5.ALL], go to step 7.
6. Do one of the following:
 - [1. CURSOR]: Select the mark to erase. To erase other marks, repeat this step. Go to step 16.
 - [2 SET RNG]: Select the starting point of the area to erase. Then select the ending point of the area to erase. The selected area is framed in a white triangle with gray border. Go to step 7.
7. Select [COLOR].
8. Press the applicable numeric key to select the mark color to erase. Select [8. ALL] to erase marks of all colors within the area you set.
9. Select [SHAPE].
10. Press the applicable numeric key or the **ENTER** knob to select the shape or figure to erase. Select [ALL] to erase marks of all shapes and figures within the area you set.
11. Select [TYPE].
[FISH TYPE SETTINGS] menu is shown on the screen.
12. Select [TYPE] again.
13. Select the fish type to erase.
[WITHOUT]: Erases marks without fish type.
[ALL]: Erases any mark having fish type.
14. Press the **MENU** key to close the [FISH TYPE SETTINGS] menu.
The number of target marks selected for erasure is displayed in [NO. OF MRK SELECTED].
15. Select [RUN] to erase the selected marks and lines.
16. Press the **DISP** key to close the menu.

4.5 How to Edit Marks, Lines

You can edit the marks and lines you have entered, and four methods of selecting range to edit are available:

- [1. CURSOR]: Edits mark, line selected with the cursor.
- [2. SET RNG]: Edits marks and lines within an area you set.
- [3. WITHIN RNG]: Edits all marks and lines currently shown on the screen.
- [4. OUT OF RNG]: Edits all marks and lines currently not shown on the screen.

Note: The marks in the internal memory that are set to [YES] on [ADD MARK/LINE DISP.] in the [DISPLAY INTERNAL MEMORY] menu (see section 10.2.2) cannot be edited.

1. Press the **MENU** key to open the main menu.
2. Select [5. MARK/TRACK EDIT/DELETE].

4. MARKS, LINES

3. Select [1. EDIT MARK].

EDIT MARK

SEL. METH. : 1. CURSOR 2. SET RNG 3. WITHIN RNG 4. OUT OF RNG

NO. OF MRK SELECTED 0

COLOR : 1. [red] 2. [yellow] 3. [green] 4. [cyan] 5. [purple] 6. [blue] 7. [white] 8. NO CHANGE

SHAPE : 1. [diamond] 2. [plus] 3. [square] 4. [Y] 5. [circle] 6. [triangle] 7. [dot] 8. [star] 9. NO CHANGE

LINE TYPE : 1. [solid] 2. [dashed] 3. [dash-dot] 4. [dotted] 5. NO CHANGE

TYPE : NO CHANGE

CATCH ENT : CHANGE NO CHANGE

CATCH VOL : 0 0 0 0 0 0 0 0 k g

COMMENT : NO CHANGE

RUN

TURN KNOB, ▲▼ : SELECT PUSH KNOB : ENTER
[MENU] : BACK

4. Select [SEL. METH.].
5. Press the applicable numeric key to select the method for editing range. For [1. CURSOR] or [2. SET RNG], go to step 6. For [3. WITHIN RNG] or [4. OUT OF RNG], go to step 7.
6. Do one of the following:
 - [1. CURSOR]: Select the mark to edit.
 - [2. SET RNG]: Select the starting point of the area to edit. Then select the ending point of the area to edit. The selected area is framed in by the white rectangle surrounded by gray.
7. Select [COLOR].
8. Press the applicable numeric key to select the new color. Select [8. NO CHANGE] to keep the previous color.
9. Select [SHAPE].
10. Push the applicable numeric key or the **ENTER** knob to select the new shape or figure. Select [NO CHANGE] to keep the previous shape.
11. Select [LINE TYPE].
12. Press the applicable numeric key to select the new line type. Select [5. NO CHANGE] to keep the previous line type.
13. Select [TYPE].
[FISH TYPE SETTINGS] menu is shown on the screen.
14. Select [TYPE] again.
15. Select the new fish type. Select [NO CHANGE] to keep the previous fish type.
16. Press the **MENU** key to close the [FISH TYPE SETTINGS] menu.
17. To enter or change the catch volume, do the following:
 - 1) Select [CATCH ENT].
 - 2) Select [CHANGE].
 - 3) Select [CATCH VOL].
 - 4) Press the numeric keys to enter the catch volume.
18. Select [COMMENT].
19. If desired, enter (or change) the comment (see "How to enter alphanumeric data" on page 1-10). Select [NO CHANGE] to keep the previous comment.
20. Select [RUN].
21. Press the **DISP** key to close the menu.

4.6 How to Undo or Redo Mark/Line Operation

You can undo previous mark/line input, edit or deletion operation by pressing the **UNDO** key. Up to 20 previous operations can be undone.

When assigning the REDO function to a function key (see section 1.7.2), press the function key to redo the last UNDO action for mark input, edit or deletion. Up to 20 UNDO actions can be redone.

4.7 How to Show Mark Information

Mark information can be shown on the screen.

Simple information

1. Press the **CURSOR ON/OFF** key to turn on the cursor.
2. Put the cursor on the mark to find its information. Data (latitude and longitude position, water temperature, depth) for the mark is shown on the screen. (Requires water temperature and depth data.)

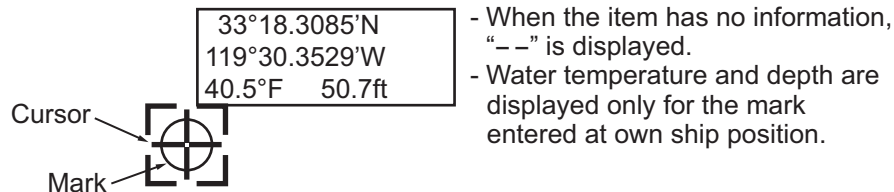

- When the item has no information, "--" is displayed.
- Water temperature and depth are displayed only for the mark entered at own ship position.

Note: If mark information does not appear, turn on [DISPLAY MARK INFO.] on page 3 of the [1. DISPLAY FORMAT] menu in the [0. SYSTEM SETTING] menu.

Detailed information

1. Press the **CURSOR ON/OFF** key to turn on the cursor.
2. Put the cursor on the mark to find its information then push the **ENTER** knob. The detailed data for the mark is shown on the screen.

MARK INFORMATION	
POSITION : 34° 43.5551'N	MARK
135° 20.5816'E	
DATE : 2015/01/01 11:08	SCREENSHOT
COMMENT : --	
FISH TYP : SALMON	
CODE : --	
L.P. : 10.4	
TIDE : +3.0ft LOW TIDE	
Ashiya	
TEMP : 38.5° F	
DEPTH : 32.7ft	
COMP : SAND	
DRIFT : 10.5° M 8.2kn	
T.C. LYR1 : 10.5° M 8.2kn	
CTCH VOL : --kg	
AREA : 891.289	
PUSH KNOB : EDIT [MENU] : CLOSE	

- When the item has no information, "--" is displayed.
- Water temperature, depth, bottom hardness, drift and tidal current layer 1 are displayed only for the mark entered at own ship position.

Note 1: When entering a mark at own ship position (see section 4.2.1), you can take a screenshot then display it on the mark information window. To take a screenshot, do the following:

4. MARKS, LINES

- 1) Press the **MENU** key to open the main menu.
- 2) Select [4. MARK/TRACK SETTING].
- 3) Select [AUTO RECORD SETTING] on page 1.
- 4) Select [SCREEN SHOT WHEN MARK INPUT] or [NO].
[SCREEN SHOT WHEN MARK INPUT]: Takes a screenshot when entering a mark at own ship position (default setting).
[NO]: Turns off the screenshot function.
- 5) Press the **DISP** key to close the menu.

Note 2: If [DRIFT/CURR. VCTR DISPLAY] ([SYSTEM SETTING] menu, [DISPLAY FORMAT] menu page 5) is set to [FROM], the drift/current display is shifted 180°.

Note 3: To change the mark information, push the **ENTER** nob. See step 7 and following steps in section 4.5 for how to edit marks.

3. Press the **MENU** or **DISP** key to close the window.

How to select the display method for mark comments

1. Press the **MENU** key to open the main menu.
2. Select [4. MARK/TRACK SETTING].
3. Select [SHOW MARK COMMENTS] on page 1.
4. Select the display method for mark comments.
[ON CHART]*: Always displays a mark comment above a mark on the screen. However, if [NUMBER OF RUN DATA MARKS TO DISPLAY] is set to [MAXIMUM NUMBER OF MARKS], the message "MAXIMUM NUMBER OF MARKS SELECTED. COMMENTS CANNOT BE SHOWN ON CHART" appears. Press the knob to clear the message.
[IN POPUP]: Displays a mark comment at the bottom of the simple information when putting the cursor on the mark.
[IN INFORMATION]: Displays a mark comment in the comment line of the detailed information when putting the cursor on the mark then pushing the **ENTER** knob.
*: Not available when [NUMBER OF RUN DATA MARKS TO DISPLAY] is set to [MAXIMUM NUMBER OF MARKS]. See the next section.
5. Press the **DISP** key to close the menu.

How to select the display method for marks

1. Press the **MENU** key to open the main menu.
2. Select [4. MARK/TRACK SETTING].
3. Select [NUMBER OF RUN DATA MARKS TO DISPLAY] on page 1.
4. Select the display method for marks.
[DEFAULT]: Always displays marks on the screen, up to a maximum of 3,000 points.
[MAXIMUM NUMBER OF MARKS]*: A maximum of 30,000 marks can be shown. When this setting is active, the [ON CHART] setting of [SHOW MARK COMMENTS] is not available. The message "MAXIMUM NUMBER OF MARKS SELECTED. COMMENTS CANNOT BE SHOWN ON CHART" appears. Press the knob to clear the message.
*: Mark comments do not appear when the setting for [SHOW MARK

COMMENTS] is [ON CHART]. To show mark comments, set [NUMBER OF RUN DATA MARKS TO DISPLAY] to [DEFAULT].

5. Select [DISPLAY OF DUPLICATE RUN DATA MARKS]* or [DISPLAY DUPLICATE INTERNAL MARKS]*.

*: See section 10.1.

6. Select the screen display method when marks overlap within a certain range.
 - [UNLIMITED]: All marks are displayed, up to a maximum of 3,000*.
 - [LIMITED]: If marks overlap within a certain range, the display is adjusted - if more than three marks overlap within a certain range, three marks are shown and the others are hidden. The maximum number of marks displayable on the screen is the same as [UNLIMITED]*.

*: When [NUMBER OF RUN DATA MARKS TO DISPLAY] is set to [MAXIMUM NUMBER OF MARKS], the maximum number of marks that can be displayed in [DISPLAY OF DUPLICATE RUN DATA MARKS] is 30,000.

7. Press the **DISP** key to close the menu.

4.8 How to Show Mark List

You can check entered marks in the mark list.

How to show the mark list

1. Press the **MENU** key to show the main menu.
2. Select [5. MARK/TRACK EDIT/DELETE].
3. Select [9. CATCH INFORMATION].
4. Select [1. MARK LIST].

Mark list is shown on the screen. Press the **PLOT INTVL** key to change the displayed items.

MARK LIST		SEL. PAGE _ 1/1	
MARK	POS/AREA	CATCH	DATE/NAME
■	34° 44.0000N, 135° 21.0000E	--	2015/01/01 11:12
⊗	34° 44.0000N, 135° 21.0000E	--	2015/01/01 11:12
■	34° 44.0000N, 135° 21.0000E	--	2015/01/01 11:12
■	34° 44.0000N, 135° 21.0000E	--	2015/01/01 11:11
⊗	34° 44.0000N, 135° 21.0000E	--	2015/01/01 11:11
■	34° 44.0000N, 135° 21.0000E	--	2015/01/01 11:10
■	34° 44.0000N, 135° 21.0000E	--	2015/01/01 11:10
■	34° 43.5551N, 135° 20.5816E	--	2015/01/01 11:08
■	34° 44.0000N, 135° 21.0000E	--	2015/01/01 11:01
■	34° 44.0000N, 135° 21.0000E	--	2015/01/01 11:01

PUSH KNOB : SHOW DETAILS [CENTER] : CENTER TARGET
 [CURSOR SEL] : FILTER SETTINGS [TRACK COLOR] : SORT SETTINGS
 [MARK COLOR] : EDIT [PLOT INTVL] : DISP SWITCH [MENU] : BACK

Mark icon, Latitude, Longitude,
Catch volume, Registration date & time

MARK LIST		SEL. PAGE _ 1/1	
MARK	POS/AREA	CATCH	DATE/NAME
■	891.289	--	--
⊗	891.289	--	--
■	891.289	--	--
■	891.289	--	--
⊗	891.289	--	--
■	891.289	--	--
■	891.289	--	--
■	891.289	--	--
■	891.289	--	--
■	891.289	--	--
■	891.289	--	--

PUSH KNOB : SHOW DETAILS [CENTER] : CENTER TARGET
 [CURSOR SEL] : FILTER SETTINGS [TRACK COLOR] : SORT SETTINGS
 [MARK COLOR] : EDIT [PLOT INTVL] : DISP SWITCH [MENU] : BACK

Mark icon, Area, Catch volume, Fish type

- ◀, ▶: Shifts the page.
- **ENTER** knob: Shows the detailed information of the selected mark (see page 4-9).
- **CENTER** key: Centers the selected mark on the plotter display.
- **CURSOR SEL** key: Shows [MARK LIST FILTER SETTINGS].
- **TRACK COLOR** key: Changes the order of the marks (see step 5).
- **MARK COLOR** key: Edit selected marks (see step 7 and following steps in section 4.5)
- **WPT** key: Enters waypoints at the selected marks (see page 4-14).
- **GOTO** key: Sets quick points at the selected marks (see page 4-14).

4. MARKS, LINES

- **DELETE** key: Deletes selected marks. The message "DELETE SELECTED MARKS IN THE LIST. ARE YOU SURE?" appears. Select [RUN] to proceed.
5. To change the order of the marks, do the following:
- 1) Press the **TRACK COLOR** key.

MARK LIST SORT SETTINGS			
SORT SELECTION	: <input type="text" value="DATE TIME"/>	FISH TYPE	CATCH VOL DISTANCE
SORT ORDER	: <input type="text" value="DES"/>	ASC	
DISTANCE TYPE	: <input type="text" value="OWN POS"/>	CUSTOM POS	
CUSTOM LAT	: 3 4 ° 4 4 . 0 0 0 0 ' N		
CUSTOM LON	: 1 3 5 ° 2 1 . 0 0 0 0 ' E		
RUN			
TURN KNOB,▲▼ : SELECT PUSH KNOB : ENTER [MENU] : BACK			

- 2) Select [SORT SELECTION].
 - 3) Select a sorting method.
[DATE TIME]: Sort the marks by date - descending (newest first) or ascending (oldest first).
[FISH TYPE]: Sort the marks by fish type - descending (Z to A) or ascending (A to Z).
[CATCH VOL]: Sort the marks by catch volume - descending (lowest first) or ascending (highest first).
[DISTANCE]: Sort the marks by distance from the own ship or the custom position.
 - 4) Select [SORT ORDER].
 - 5) Refer to the above 3), and select [DES] or [ASC].
If you selected [DISTANCE] in the above 3), proceed to the 6). If you selected anything else, proceed to 12).
 - 6) Select [DISTANCE TYPE].
 - 7) Select [OWN POS] or [CUSTOM POS].
If you select [CUSTOM POS], proceed to the 8). If you select [OWN POS], proceed to step 12).
 - 8) Select [CUSTOM LAT].
 - 9) Press the numeric keys to enter the latitude of the custom position.
To switch the coordinate from North to South and vice versa, use the **CURSOR ON/OFF** key.
 - 10) Select [CUSTOM LON].
 - 11) Press the numeric keys to enter the longitude of the custom position.
To switch the coordinate from East to West and vice versa, use the **CURSOR ON/OFF** key.
 - 12) Select [RUN].
6. Press **DISP** key to close the mark list.

How to use filter settings on the mark list

Using the filter settings makes it easier to find the target mark in the mark list.

1. Show the mark list (see page 4-11).

2. Press the **CURSOR SEL** key.

MARK LIST FILTER SETTINGS	
FILTER SELECTION	: 1. DATE AND TIME 2. FISH TYPE 3. CATCH VOLUME 4. AREA 5. COLOR AND SHAPE 6. NONE
DATE AND TIME FILTER	
START DATE	: 2 0 0 0 / 0 1 / 0 1
START TIME	: 0 0 : 0 0
END DATE	: 2 0 9 9 / 1 2 / 3 1
END TIME	: 2 3 : 5 9
FISH TYPE FILTER	
TYPE	: [WITHOUT]
CATCH VOLUME FILTER	
MIN CATCH VOL	: 0 0 0 0 0 0 0 k g
MAX CATCH VOL	: 9 9 9 9 9 9 9 k g
AREA FILTER	
UPPER 3 DIGITS	: 0 0 0
LOWER 3 DIGITS	: 0 0 0
COLOR AND SHAPE FILTER	
COLOR	: 1 [red] 2 [yellow] 3 [green] 4 [cyan] 5 [blue] 6 [purple] 7 [white] 8. NONE
SHAPE	: 1 [diamond] 2 [plus] 3 [square] 4 [Y] 5 [circle] 6 [triangle] 7 [dot] 8 [star] 9 [cross] 0 [WITHOUT]
RUN	
TURN KNOB, ▲▼ : SELECT PUSH KNOB : ENTER [MENU] : BACK	

3. Select [FILTER SELECTION].

4. Select the filtering method.

[1. DATE AND TIME]: Sets the start and end dates/times to show the marks entered during that period.

[2. FISH TYPE]: Sets the fish type to show the target marks.

[3. CATCH VOLUME]: Sets the maximum and minimum catch volumes to show the marks within the range.

[4. AREA]: Sets the upper and lower three digits area to show the target marks.

[5. COLOR AND SHAPE]: Sets the color or shape to show the target marks.

[6. NONE]: Shows all marks (no filter).

The filter selected above becomes active.

5. Set the filter settings.

How to set [1. DATE AND TIME]

1) Select [START DATE].

2) Press the numeric keys to enter the start date.

3) Select [START TIME].

4) Press the numeric keys to enter the start time.

5) Select [END DATE].

6) Press the numeric keys to enter the end date.

7) Select [END TIME].

8) Press the numeric keys to enter the end time.

How to set [2. FISH TYPE]

1) Select [FISH TYPE].

[FISH TYPE SETTINGS] menu is displayed on the screen.

2) Select [FISH TYPE] again.

3) Select the fish type to set.

4) Press the **MENU** key to close the [FISH TYPE SETTINGS] menu.

How to set [3. CATCH VOLUME]

1) Select [MIN CATCH VOL].

4. MARKS, LINES

- 2) Press the numeric keys to enter the minimum catch volume.
- 3) Select [MAX CATCH VOLUME].
- 4) Press the numeric keys to enter the maximum catch volume.

How to set [4. AREA]

- 1) Select [UPPER 3 DIGITS].
- 2) Press the numeric keys to set the area (upper three digits).
- 3) Select [LOWER 3 DIGITS].
- 4) Press the numeric keys to set the area (lower three digits).

How to set [5. COLOR AND SHAPE]

- 1) Select [COLOR].
- 2) Press the applicable numeric key to select the color.
Select [8. NONE] to specify no color.
- 3) Select [SHAPE].
- 4) Press the applicable numeric key or rotate the **ENTER** knob to select the shape or number.
Select [WITHOUT] to specify no shape.

6. Select [RUN].
7. Press the **DISP** key to close the mark list.

How to enter waypoints from the mark list

Waypoints can be entered at the selected marks.

1. Show the mark list (see page 4-11).
2. Select a mark to set as a waypoint.
3. Press the **WPT** key.
A way point is set at the mark selected in step 2. The way point name is assigned the lowest available number. Registered waypoints are saved in the [WAYPOINTS LIST].
4. Press the **DISP** key to close the mark list.

How to set quick points

A quick point or quick point route can be set at the selected mark(s). See section 7.1 for details.

1. Show the mark list (see page 4-11).
2. Select a mark to set as a quick point.
3. Press the **GOTO** key.
A quick point is set at the mark selected in step 2, and the name "QP<001" is assigned to it. The route created from quick points is saved in the [ROUTES LIST] under the name "Q<RTE".
4. Press the **DISP** key to close the mark list.

4.9 Mark Filter

Marks can be shown or hidden according to mark attribution.

How to set object and content for the mark filter

1. Push the **ENTER** knob. The mark filter at the bottom right of the screen is highlighted.

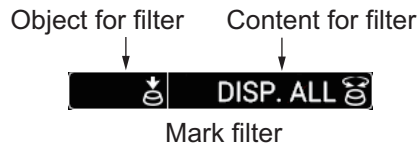

Note 1: The mark filter can be selected regardless of cursor state. When the cursor is on, push the **ENTER** knob to highlight the mark filter at the position where no target (e.g. a mark) is selected with the cursor.

Note 2: The settings for the mark filter are automatically undone when there is no operation for 10 seconds.

2. Push the **ENTER** knob to select the object to filter. Each push of the knob selects the object as follows:
No indication (no filter) → [TYPE] → [COLOR] → [SHAPE] → [DATE] → [COMP] → [TEMP] → [DEPTH] → [C. DIR] → [C. SPD] → [MULTI] → No indication (no filter) → ...
Each object can be shown or hidden on the mark filter box. For details, see "How to turn on or off an object to filter" on page 4-17.
3. Rotate the **ENTER** knob to select content to filter. The marks of selected object and content to filter are displayed on the screen.



Example 1
Object to filter: [COLOR]
Content to filter: [RED]



Example 2
Object to filter: [DEPTH]
Content to filter: [32.8ft]

Object for filter	Option of content to filter	Meaning
No indication	[DISP. ALL]	No filter. Displays all marks.
[TYPE]	[DISP. ALL], fish type set in the [MARK FILTER FISH TYPE SETTING] menu (up to 10 types)	Displays marks for the selected fish type. See "How to set the fish type for the mark filter" on page 4-17.
[COLOR]	[DISP. ALL], [RED], [YELLOW], [GREEN], [LIGHT BLUE], [PURPLE], [BLUE], [WHITE]	Displays marks for the selected color.
[SHAPE]	[DISP. ALL], [◇], [+], [□], [∇], [○], [△], [·], [☆], [×], [凸], [凹], [↖], [1], [2], [3], [4], [5], [6], [7], [8], [9], [0]	Displays marks for the selected shape.
[DATE]	[DISP. ALL], [FRM 1 WEEK], [FRM 30DAYS], [FRM 1 YEAR], [THIS TERM], [THIS TIME], [AA/AA~BB/BB], [AA/AA TO NOW]	Displays marks entered at the selected date (period). For details, see "How to set the date for the mark filter" on page 4-18.

4. MARKS, LINES

Object for filter	Option of content to filter	Meaning
[COMP]	[DISP. ALL], [MUD], [SAND], [GRAVEL],[ROCK]	Displays marks for the selected bottom hardness. Requires the information for bottom hardness (see "Detailed information" on page 4-9).
[TEMP]	[DISP. ALL], [32.0°F] to [86.0°F]	Displays marks with temperature $\pm 0.05^\circ\text{F}$ of the setting. When 32.0°F (minimum) is set, displays marks with temperature below 32.0°F. When 86.0°F (maximum) is set, displays marks with temperature above 86.0°F.
[DEPTH]	[DISP. ALL], [0.0ft] to [656 ft]	When setting depth under 328 ft, display marks with depth ± 8 ft of the setting. When setting depth more than 328 ft, display marks with depth ± 16 ft of the setting. When 0.0 ft (minimum) is set, displays marks with depth below 0.0 ft. When 656 ft (maximum) is set, displays marks with depth above 656 ft.
[L. P.]	[DISP. ALL], [0] to [30] (1 step)	Displays marks at the age of ± 1 months for the setting.
[TIDE]	[DISP. ALL], [LOW TIDE], [30% UP], [50% UP], [70% UP], [HIGH TIDE], [30% LOW], [50% LOW], [70% LOW]	Displays marks for the selected tide level.
[C. DIR]	[DISP. ALL], [0.0°T (or °M)] to [350.0°T (or °M)] (10° step)	Displays marks with current direction $\pm 10^\circ$ of the setting. Note: If [DRIFT/CURR. VCTR DISPLAY] ([SYSTEM SETTING] menu, [DISPLAY FORMAT] menu page 5) is set to [FROM], the drift/current indication is rotated 180° and the mark filter is applied.
[C. SPD]	[DISP. ALL], [0.0kn] to [5.0kn] (0.2 kn step)	Displays marks with current speed ± 0.1 kn of the setting. When 5.0 kn (maximum) is set, displays marks with current speed over 5.0 kn.
[MULTI]	[MULTI DISP]	Displays marks fulfilled in all filter options set.

Note: The marks entered after setting the mark filter are not hidden.

How to turn on or off an object to filter

1. Press the **MENU** key to open the main menu.
2. Select [4. MARK/TRACK SETTING].
3. Go to page 5 to show the [DISPLAY MARK FILTER] menu.

MARK/TRACK SETTING		SEL. PAGE	◀5/6▶
DISPLAY MARK FILTER			
FISH TYPE	: ON	OFF	
COLOR	: ON	OFF	
SHAPE	: ON	OFF	
DATE	: ON	OFF	
SEABED COMPOSITION	: ON	OFF	
WATER TEMPERATURE	: ON	OFF	
DEPTH	: ON	OFF	
LUNAR PHASE	: ON	OFF	
TIDE LEVEL	: ON	OFF	
CURRENT DIRECTION	: ON	OFF	
CURRENT SPEED	: ON	OFF	
MULTI	: ON	OFF	

TURN KNOB, ▲▼ : SELECT PUSH KNOB : ENTER
 [0]~[9] : NO. OF PAGE ◀▶ : MOVE PAGE
 [MENU] : BACK

4. Select any one from [FISH TYPE] to [MULTI].
5. Select [ON] or [OFF]. The objects to filter which are set to [ON] are turned on when pushing the **ENTER** knob. (See step 2 at "How to set object and content for the mark filter" on page 4-15.)

How to set the fish type for the mark filter

You can set the option of content for [TYPE] (fish type).

1. Press the **MENU** key to open the main menu.
2. Select [4. MARK/TRACK SETTING].
3. Go to page 6 to show the [MARK FILTER FISH TYPE SETTING] menu. Select any option from [TYPE OF FISH 1] to [TYPE OF FISH 10] to display the character entry window.

MARK/TRACK SETTING		SEL. PAGE	◀6/6▶
MARK FILTER FISH TYPE SETTING			
TYPE OF FISH 1	:		
TYPE OF FISH 2	:		
TYPE OF FISH 3	:		
TYPE OF FISH 4	:		
TYPE OF FISH 5	:		
TYPE OF FISH 6	:		
TYPE OF FISH 7	:		
TYPE OF FISH 8	:		
TYPE OF FISH 9	:		
TYPE OF FISH 10	:		
MARK FILTER DATE & TIME SETTING			
STARTING DATE	:	2000/01/01	
FINISHING DATE	:	2099/12/31	

TURN KNOB, ▲▼ : SELECT PUSH KNOB : ENTER
 [0]~[9] : NO. OF PAGE ◀▶ : MOVE PAGE
 [MENU] : BACK

TYPE OF FISH 1		SELECTIONS:
A B C D E	F G H I J	K L M N O
P Q R S T	U V W X Y	Z { }
. , - ! ?	/ & = # _	1 2 3 4 5
6 7 8 9 0	◀ ▶ Space	Delete
ENTER		
ROTATE KNOB : INPUT CHARS. [CANCEL] : DELETE ALL		
[CURSOR ON/OFF] : SWITCH UPPER/LOWER CASE		
[1]~[5] : ABBR. SELECTIONS [MENU] : BACK		

Character entry window for [TYPE OF FISH 1]

4. MARKS, LINES

4. Set the fish type (see "How to enter alphanumeric data" on page 1-10). After Selecting [ENTER], the message "CHANGING THE FISH NAME WILL AFFECT THE FISH CODE IN THE FISH TYPE LIST." appears.
5. Push the **ENTER** knob.
Go back to the [MARK/TRACK SETTING] menu on page 6, and the fish type you set appears to the right of [TYPE OF FISH 1 or 2 to 10] selected in step 3.
6. Press the **DISP** key to close the menu.

How to set the date for the mark filter

When selecting [DATE] as object for filter, each push of the knob selects the option of content as follows:

[DISP. ALL] → [FRM 1 WEEK] → [FRM 30DAYS] → [FRM 1 YEAR] → [THIS TERM] → [THIS TIME] → [AA/AA TO BB/BB] → [AA/AA TO NOW]

[THIS TERM]: Displays marks of plus or minus one month from the current date (regardless of year).

[THIS TIME]: Displays marks of plus or minus three hours from the current time (regardless of date).

To set the month and day for AA/AA or BB/BB, do the following:

1. Press the **MENU** key to open the main menu.
2. Select [4. MARK/TRACK SETTING].
3. Go to page 6 to show the [MARK FILTER DATE & TIME SETTING] menu.
4. Select [STARTING DATE].
5. Set the starting date (AA/AA) with the numeric keys.
6. Select [FINISHING DATE].
7. Set the ending date (BB/BB) with the numeric keys.
8. Press the **DISP** key to close the menu.

4.10 How to Send Mark Data to Radar

The mark data of the GP-3700F can be sent to the radar FR-12 (with RT board).

Note: To send mark data, connect the GP-3700F to the FR-12 (with RT board) via LAN.

How to activate marks transmission

1. Press the **MENU** key to open the main menu.
2. Select [0. SYSTEM SETTING].
3. Select [5. INPUT/OUTPUT PORT SETTING].
4. Select [7. ETHERNET SETTING].



ETHERNET SETTING	
IP ADDRESS	: 172. 031. 014. 006
SUBNET MASK	: 255. 255. 000. 000
DEFAULT GATEWAY	: 000. 000. 000. 000
FA-30 IP ADDRESS	: 172. 031. 024. 002
MARK SEND SETTINGS(RADAR)	: YES <input type="checkbox"/> NO <input type="checkbox"/>
TURN KNOB, ▲▼ : SELECT PUSH KNOB : ENTER [MENU] : BACK	

5. Select [MARK SEND SETTINGS (RADAR)].
6. Select [YES]. The message "SENDING MARKS TO RADAR MAY NOT BE PERFORMED CORRECTLY WHEN TTM SENTENCE IS OUTPUT. PLEASE REFER TO OPERATION MANUAL." appears. Push the **ENTER** knob. Confirm your selection for [OUTPUT TTM], referring to subsection 9.5.1.

Note: When using the function of marks transmission, there are restrictions on the use of the function for the TTM sentence output. You can select [OUTPUT] in [OUTPUT TTM] to only one port. Also, you cannot enter TT data. When selecting [NO OUTPUT] in [OUTPUT TTM], there are no restrictions on the input of TT data.

7. Press the **DISP** key to close the menu.

When the function of marks transmission is available, the icon, which shows the status of marks transmission, is displayed.

Icon	Meaning
	Sending marks data. Note: When the number of marks data to be sent is small, this icon may not be displayed because transmission is completed before the screen update.
	Transmission is available. (Connection to the radar is correct.)
	Transmission is not available. (Connection to the radar is not correct.)

How to send all marks data

Note: If you unplug the LAN cable connected to this unit while the unit is powered, reconnect the LAN cable and then send all marks data. After the transmission failure message is displayed, this unit is reconnected and you can send marks data.

1. Press the **MENU** key to open the main menu.
2. Select [5. MARK/TRACK EDIT/DELETE].
3. Select [8. SEND ALL MARKS].
4. Select [1. SEND MARKS TO RADAR]. The following confirmation message appears.

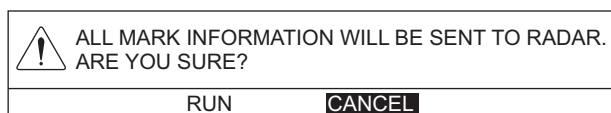

5. Select [RUN].

Note 1: Marks transmission cannot be stopped in mid-transmission. If you send marks data again during transmission, marks data is sent from the beginning.

Note 2: A maximum of 30,000 marks data can be sent, which takes max. six minutes and thirty seconds.

Note 3: When adding or deleting a mark on this equipment, only the changed data is sent to the FR-12 (with RT board). However, when editing or deleting a mark from the menu, the data is not updated. Clear marks data on the FR-12 (with RT board), and then send marks data again.

6. Press the **DISP** key to close the menu.

4. MARKS, LINES

How to filter marks data to be sent

You can set up to five types for marks to be displayed on the radar from the menu of the GP-3700F.

1. Press the **MENU** key to open the main menu.
2. Select [5. MARK/TRACK EDIT/DELETE].
3. Select [8. SEND ALL MARKS]
4. Select [2. SEND MARK FILTER TO RADAR].

SEND MARK FILTER TO RADAR	
SELECT	1. MARK FILTER 1 2. MARK FILTER 2 3. MARK FILTER 3 4. MARK FILTER 4 5. MARK FILTER 5 6. CLEAR FILTERS
MARK FILTER 1	
COLOR	1. ■ 2. ■ 3. ■ 4. ■ 5. ■ 6. ■ 7. 8. NONE
SHAPE	1. 2. + 3. 4. Y 5. 6. △ 7. • 8. ☆ ⊗
	⊗ ⊕ ⊖ ⊗ 1 2 3 4 5 6 7 8 9 0 NONE
MARK FILTER 2	
COLOR	1. ■ 2. ■ 3. ■ 4. ■ 5. ■ 6. ■ 7. 8. NONE
SHAPE	1. 2. + 3. 4. Y 5. 6. △ 7. • 8. ☆ ⊗
	⊗ ⊕ ⊖ ⊗ 1 2 3 4 5 6 7 8 9 0 NONE
MARK FILTER 3	
COLOR	1. ■ 2. ■ 3. ■ 4. ■ 5. ■ 6. ■ 7. 8. NONE
SHAPE	1. 2. + 3. 4. Y 5. 6. △ 7. • 8. ☆ ⊗
	⊗ ⊕ ⊖ ⊗ 1 2 3 4 5 6 7 8 9 0 NONE
MARK FILTER 4	
COLOR	1. ■ 2. ■ 3. ■ 4. ■ 5. ■ 6. ■ 7. 8. NONE
SHAPE	1. 2. + 3. 4. Y 5. 6. △ 7. • 8. ☆ ⊗
	⊗ ⊕ ⊖ ⊗ 1 2 3 4 5 6 7 8 9 0 NONE
MARK FILTER 5	
COLOR	1. ■ 2. ■ 3. ■ 4. ■ 5. ■ 6. ■ 7. 8. NONE
SHAPE	1. 2. + 3. 4. Y 5. 6. △ 7. • 8. ☆ ⊗
	⊗ ⊕ ⊖ ⊗ 1 2 3 4 5 6 7 8 9 0 NONE
RUN	
TURN KNOB, ▲▼ : SELECT PUSH KNOB : ENTER [MENU] : BACK	

5. Select [1. MARK FILTER 1] in [SELECT] to move the cursor to [COLOR] in [MARK FILTER 1]. Select [6. CLEAR FILTERS] to send all marks data.
6. Press the applicable numeric key to select the mark color to filter at [COLOR] in [MARK FILTER 1]. Select [8. NONE] to send marks data for all colors.
7. Select the mark shape to filter at [SHAPE] in [MARK FILTER 1]. Select [NONE] to send marks data for all shapes.
8. Press the **MENU** key to move the cursor to [SELECT].
9. Set [MARK FILTER 2] to [MARK FILTER 5] in the same manner.
10. Select one among [1. MARK FILTER 1] to [6. CLEAR FILTERS] in [SELECT] to send the filtered mark data.
11. Select [RUN] to send marks data.

Note: If you select [RUN] when transmission is not available, the message "MARKS CANNOT BE SENT. CHECK SETTINGS AND CONNECTIONS." appears. Push the **ENTER** knob, check connections and settings are correct, then re-send the marks data.
12. Press the **DISP** key to close the menu.

5. WAYPOINTS

In navigation terminology, a waypoint is a particular geographical location on a voyage whether it be a starting, intermediate or destination point. A waypoint is the simplest piece of information your equipment requires to get you to a destination, in the shortest distance possible.

5.1 How to Enter Waypoints

This unit has 3,500 waypoints into which you can enter position information. There are seven methods to enter a waypoint as follows:

- Enter a waypoint at own ship position.
- Enter a waypoint at the cursor position.
- Enter a waypoint by manually entering latitude and longitude position.
- Enter a waypoint by range and bearing.
- Enter a waypoint by Loran-C LOP.
- Enter a waypoint by Loran-A LOP.
- Enter a waypoint by Decca LOP.

Waypoints can be entered from the echo sounder display.

5.1.1 How to enter waypoints at own ship position

1. Press the **SAVE MOB** key. The following message appears.

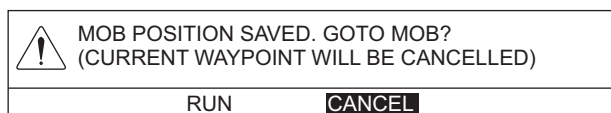

The MOB mark () appears at own ship position and registered as a waypoint. This waypoint is automatically named "MOB" and saved in the [WAYPOINTS LIST].

2. Select [RUN] to set the waypoint as the destination, [CANCEL] to cancel the waypoint as the destination.

You can enter a waypoint at own ship position by pressing the **WPT** key when the cursor is off. See step 3 or after in section 5.1.2.

5.1.2 How to enter waypoints at the cursor position

1. Press the **CURSOR ON/OFF** key to turn on the cursor.
2. Put the cursor on the position where you want to enter a waypoint.
3. Press the **WPT** key to show the [WAYPOINTS LIST] window.

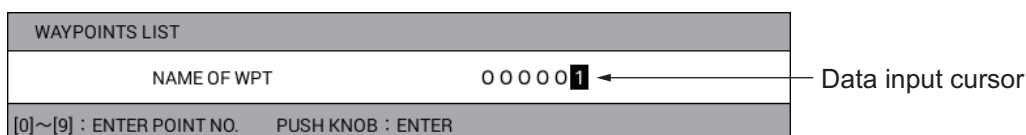

5. WAYPOINTS

Note: The [WAYPOINTS LIST] window closes automatically when there is no operation for 10 seconds.

4. Press the numeric keys to enter the name of the waypoint (six digits) then push the **ENTER** knob. The currently indicated waypoint number is the youngest number among the unused numbers. If you do not need to change the number, go to step 5. Each time a numeric key is pressed, the cursor jumps one place leftward. To set the number "000005", for example, press the **0, 0, 0, 0, 0, 5** keys in order.
5. Push the **ENTER** knob to save the waypoint. The currently selected shape and color for the waypoint mark is shown at the bottom right of the screen as the icon (default: circle in red).

Note 1: The waypoint icon may not be shown at the bottom right of the screen depending on the menu setting. If it is not shown, you can show it as follows:

- 1) Press the **MENU** key to open the main menu.
- 2) Select [0. SYSTEM SETTING], [1. DISPLAY FORMAT] in order.
- 3) Select [WAYPOINT STATUS] on page 3 then set to [SHOW].

Note 2: If above operation is done when the cursor is off, the waypoint is entered at own ship position.

Note 3: If the waypoint number set at step 4 is already used, the following message appears.

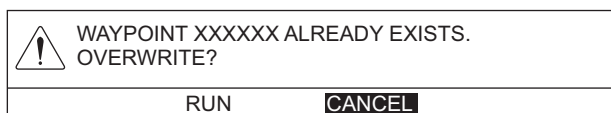

Select [RUN] to overwrite, or [CANCEL] to cancel then enter a different number.

5.1.3 How to enter waypoints by manually entering latitude and longitude position

1. Press the **MENU** key to open the main menu.
2. Select [1. ROUTES/WAYPOINTS LIST].

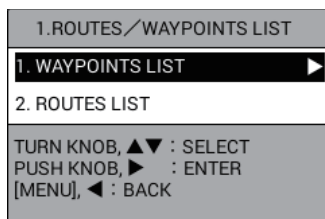

5. WAYPOINTS

12. Set the waypoint name (see "How to enter alphanumeric data" on page 1-10).
13. Select [MARK COLOR].
14. Select the mark color.
15. Select [MARK SHAPE].
16. Select the mark shape.
17. Select [MARK DISPLAY].
18. Select [YES] or [NO].
[YES]: Shows the waypoint mark on the plotter display.
[NO]: Hides the waypoint mark on the plotter display. Waypoint marks selected to [NO] are grayed out in [WAYPOINTS LIST].
19. Select [INT. BAN].
20. Press the numeric keys to enter the intrusion ban alarm radius.
[INT. BAN] is the alarm range that will be used for this waypoint when the intrusion point alarm is active. When the intrusion ban alarm radius is other than 0.00 NM, the waypoint marks on the plotter display and the waypoint list become  automatically. For how to set the intrusion point alarm, see section 8.5.
21. Select [COMMENT].
22. Enter the comment (see "How to enter alphanumeric data" on page 1-10).
23. Select [RUN] to close the [EDIT WPT NAME] window.
24. Press the **DISP** key to close the menu.









5.1.4 How to enter waypoints by range and bearing

This method is useful when you want to enter a waypoint by using range and bearing to a target found on the radar display.

1. Press the **MENU** key to open the main menu.
2. Select [1. ROUTES/WAYPOINTS LIST].
3. Select [1. WAYPOINTS LIST].
4. Press the **WPT** key or **ENTER** knob to show the [EDIT WPT NAME] window.
Note: Push the **ENTER** knob after selecting a blank line.
5. Select [COORDINATE].

6. Select [RANGE/BEARING].

When selecting [RANGE/BEARING] in [COORDINATE], [DISTANCE] and [BRG] are displayed here.

EDIT WPT NAME	
NAME OF WPT	: 000001
DISTANCE	: 0 0 0 . 0 6 2 NM
BRG	: 0 1 7 . 8 °M
MARK COLOR	: ■ ■ ■ ■ ■ ■ ■
MARK SHAPE	:         
MARK DISPLAY	: <input checked="" type="checkbox"/> YES NO
COORDINATE	: LATITUDE/LONGITUDE RANGE/BEARING TIME DIFFERENCE
INT. BAN	: 0 . 0 0 NM
COMMENT	: 09:10 1501.01
RUN	
TURN KNOB, ▲▼ : SELECT PUSH KNOB : ENTER [MENU] : BACK	

7. Select [DISTANCE].

8. Press the numeric keys to enter the range from own ship to the waypoint.

9. Select [BRG].

10. Press the numeric keys to enter the bearing from own ship to the waypoint.

11. Follow the procedure from step 11 in section 5.1.3.

5.1.5 How to enter waypoints by Loran A or Loran C LOPs

1. Press the **MENU** key to open the main menu.

2. Select [8. PLOTTER DISPLAY SETTING].

3. Select [3. LORAN/DECCA SETTING].

LORAN/DECCA SETTING	
LORAN A STA. COMB.	: 0 0 - 0 1
TIME OFFSET 1	: + 0 0 0 . 0 μ s
TIME OFFSET 2	: + 0 0 0 . 0 μ s
LORAN C STA. COMB.	: 0 0 : 1 1 - 2 9
TIME OFFSET 1	: + 0 0 0 . 0 μ s
TIME OFFSET 2	: + 0 0 0 . 0 μ s
DECCA CHAIN	: 0 1 R - G
OFFSET VALUE 1	: + 0 0 . 0 0 L A N E
OFFSET VALUE 2	: + 0 0 . 0 0 L A N E
TIME DIFF. DISP TYPE	: LORAN A LORAN C DECCA
LOP FORMULA	: NEW EARLIER
CH CODE LIST 00:1L0 01:1L1 02:1L4 03:1L5 04:1L6 05:1L7 06:1S1 07:1S2 08:1S3 09:1S4 10:1S6 11:2H3 12:2H4 13:2H5 14:2H6 15:2S0 16:2S1 17:2S2 18:2S3 19:2S4 20:2S5 21:2S6 22:2S7	
TURN KNOB, ▲▼ : SELECT PUSH KNOB : ENTER [MENU] : BACK	

4. Select [TIME DIFF. DISP TYPE].

5. Select [LORAN A] or [LORAN C].

6. Press the **MENU** key twice to return to the main menu.

7. Select [1. ROUTES/WAYPOINTS LIST].

5. WAYPOINTS

8. Select [1. WAYPOINTS LIST].
9. Press the **WPT** key or **ENTER** knob to show the [EDIT WPT NAME] window.
Note: Push the **ENTER** knob after selecting a blank line.
10. Select [COORDINATE].
11. Select [TIME DIFFERENCE].

When selecting [TIME DIFFERENCE] in [COORDINATE], [TME ADJ1] and [TME ADJ2] are displayed here.

EDIT WPT NAME	
NAME OF WPT	: 000001
TME ADJ1	: 1 1 1 7 5 . 3
TME ADJ2	: 3 5 0 6 4 . 0
GRI : 4990 11-29	
MARK COLOR	: <input type="checkbox"/> <input type="checkbox"/> <input type="checkbox"/> <input type="checkbox"/> <input type="checkbox"/> <input type="checkbox"/> <input type="checkbox"/>
MARK SHAPE	: <input type="checkbox"/> <input type="checkbox"/> <input type="checkbox"/> <input type="checkbox"/> <input type="checkbox"/> <input type="checkbox"/> <input type="checkbox"/> <input type="checkbox"/> <input type="checkbox"/> <input type="checkbox"/>
MARK DISPLAY	: <input checked="" type="checkbox"/> YES <input type="checkbox"/> NO
COORDINATE	: LATITUDE/LONGITUDE RANGE/BEARING TIME DIFFERENCE
INT. BAN	: 0 . 0 0 NM
COMMENT	: 09:12 1501.01
RUN	
TURN KNOB, ▲▼ : SELECT PUSH KNOB : ENTER [MENU] : BACK	

12. Select [TME ADJ1].
13. Press the numeric keys to enter the time difference 1.
14. Select [TME ADJ2].
15. Press the numeric keys to enter the time difference 2.
16. Follow the procedure from step 11 in section 5.1.3.

5.1.6 How to enter waypoints by Decca LOPs

1. Press the **MENU** key to open the main menu.
2. Select [8. PLOTTER DISPLAY SETTING].
3. Select [3. LORAN/DECCA SETTING].
4. Select [TIME DIFF. DISP TYPE].
5. Select [DECCA].
6. Press the **MENU** key twice to return to the main menu.
7. Select [1. ROUTES/WAYPOINTS LIST].
8. Select [1. WAYPOINTS LIST].
9. Press the **WPT** key or **ENTER** knob to show the [EDIT WPT NAME] window.
Note: Push the **ENTER** knob after selecting a blank line.
10. Select [COORDINATE].

11. Select [TIME DIFFERENCE].

When selecting [TIME DIFFERENCE] in [COORDINATE], [LANE 1] and [LANE 2] are displayed here.

EDIT WPT NAME	
NAME OF WPT	: 000001
LANE 1	: 1 G : 0 3 . 5 4
LANE 2	: 1 F : 3 3 . 7 4
CHAIN : 01 S BALTIC R-G	
MARK COLOR	:
MARK SHAPE	:
MARK DISPLAY	: <input checked="" type="checkbox"/> YES NO
COORDINATE	: LATITUDE/LONGITUDE RANGE/BEARING <input checked="" type="checkbox"/> TIME DIFFERENCE
INT. BAN	: 0 . 0 0 NM
COMMENT	: 09:13 1501.01
RUN	
TURN KNOB, ▲▼ : SELECT PUSH KNOB : ENTER [MENU] : BACK	

12. Select [LANE 1].

13. Press the numeric keys to enter the value for [LANE 1]. Enter the alphabet of the lane by pressing applicable numeric key, referring to the following:

1 key: A	2 key: B	3 key: C	4 key: D
5 key: E	6 key: F	7 key: G	8 key: H
9 key: I	0 key: J		

To set "1F: 22.01", for example, press the **1, 6, 2, 2, 0, 1** keys in order.

14. Select [LANE 2].

15. Press the numeric keys to enter the value for [LANE 2].

16. Follow the procedure from step 11 in section 5.1.3.

5.2 How to Edit Waypoints

You can edit waypoints from the waypoints list.

1. Press the **MENU** key to open the main menu.
2. Select [1. ROUTES/WAYPOINTS LIST].
3. Select [1. WAYPOINTS LIST].
4. Select the waypoint to edit. The [EDIT WPT NAME] window appears.

Note 1: Waypoints can be sorted by alphanumeric order, distance to own ship, mark type, or registration order (see section 5.4).

Note 2: A waypoint's color or shape cannot be changed when its [INT. BAN] is other than 0.00 NM.

Note 3: The color and shape of the last-edited waypoint will be used hereafter for the waypoint entered at own ship position and cursor position.
5. Select the item to edit, then edit its attributes as required (see section 5.1.3).
6. Select [RUN] to show the following message.

	WAYPOINT XXXXXX ALREADY EXISTS. OVERWRITE?
RUN	CANCEL

7. Select [RUN].

5. WAYPOINTS

8. Press the **DISP** key to close the menu.

5.3 How to Erase a Waypoint

A waypoint can be erased with the cursor or from the waypoints list.

How to erase a waypoint with the cursor

1. Press the **CURSOR ON/OFF** key to display the cursor.
2. Put the cursor on the waypoint to erase.
3. Press the **CANCEL** key to show the following message.

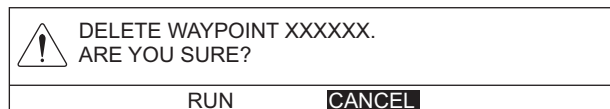

4. Select [RUN] to erase the waypoint from the screen and the waypoints list.

How to erase a waypoint from the waypoints list

1. Press the **MENU** key to open to the main menu.
2. Select [1. ROUTES/WAYPOINTS LIST].
3. Select [1. WAYPOINTS LIST].
4. Select the waypoint to erase then press the **CANCEL** key. The following message appears.

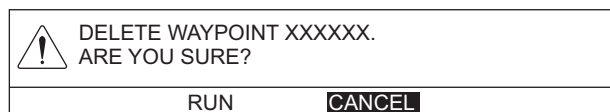

5. Select [RUN] to erase the waypoint from the waypoints list and the screen.
6. Press the **DISP** key to close the menu.

5.4 How to Search Waypoints

You can search waypoints by sort method (alphanumeric order, distance to own ship, mark type, registration order), or waypoint name.

How to search waypoints by search method

1. Press the **MENU** key to open the main menu.
2. Select [1. ROUTES/WAYPOINTS LIST].
3. Select [1. WAYPOINTS LIST].
4. Select [SORT].
5. Select the search method.
 - [ALPHA. ORD]: Sorts waypoints in order of MOB, numbers, alphabets.
 - [RNG ORDER]: Sorts waypoints in order of increasing distance to own ship.
 - [MARK SHAPE]: Sorts waypoints in order of MOB mark, proximity radius mark and other mark shapes (in order of indication on the [EDIT WPT NAME] window).
 - [REG. ORDER]: Sorts waypoints in order of registration. The last-registered waypoint is at the top of the list.

6. Press the **DISP** key to close the menu.

How to search by waypoint name

1. Press the **MENU** key to open the main menu.
2. Select [1. ROUTES/WAYPOINTS LIST].
3. Select [1. WAYPOINTS LIST].
4. Select [SEARCH] to show the [SEARCH] window.
5. Enter the first three characters of the waypoint name (see "How to enter alphanumeric data" on page 1-10) then select [ENTER]. The waypoint that best matches the search criteria is displayed at the top of the waypoints list.
6. Press the **DISP** key to close the menu.

5.5 How to Set Speed to Use in TTG Calculation

Calculation of TTG is based on ship's speed data. Speed can be set manually or automatically.

1. Press the **MENU** key to open the main menu.
2. Select [1. ROUTES/WAYPOINTS LIST].
3. Select [1. WAYPOINTS LIST].
4. Select [SPD FOR TTG CALC].
5. Select [T. SHP SPD] or [ENT VALU].
[T. SHP SPD]: Calculate TTG with the actual ship's speed. Go to step 7.
[ENT VALU]: Calculate TTG with manually entered speed. Go to step 6.
6. Press the numeric keys to enter speed. TTG for the selected waypoint is calculated using the speed entered here.
7. Highlight the waypoint on the waypoints list to show its TTG ([TIME TO GO]) and ETA ([EST TIME OF ARR.]) at the bottom right of the screen.
8. Press the **DISP** key to close the menu.

5.6 How to Display Waypoint Information

You can show the latitude and longitude position and the comment for a waypoint

1. Press the **CURSOR ON/OFF** key to display the cursor.
2. Put the cursor on the waypoint to find its information. A window showing the latitude and longitude position and comment for the waypoint appears.

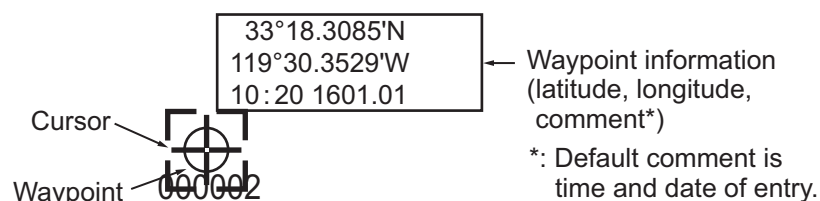

Note: The data window may not appear depending on menu setting. To show the window, set [WAYPOINT INFORMATION] to [SHOW] in the [1. DISPLAY FORMAT] menu.

5.7 How to Change Waypoint Mark Size

You can change the size of all waypoints to small or large, or turn them off.

1. Press the **MENU** key to open the main menu.
2. Select [7. COAST LINE SETTING].

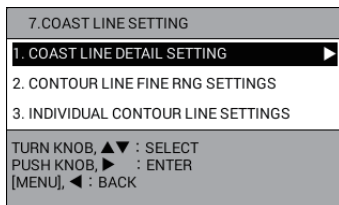

3. Select [1. COAST LINE DETAIL SETTING].

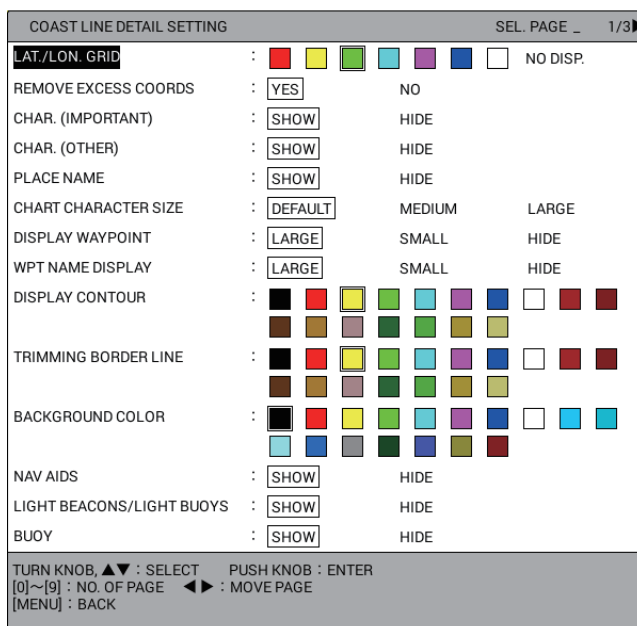

4. Select [DISPLAY WAYPOINT] on page 1.
5. Select [LARGE], [SMALL], or [HIDE].
 [LARGE]: Waypoints are shown in actual mark shape.
 [SMALL]: Waypoints are shown with an “x” regardless of mark shape selected.
 [HIDE]: All waypoints are turned off except the waypoint destination and route.
6. Press the **DISP** key to close the menu.

5.8 How to Mark Radar Target Position

With connection of a radar that supports TLL (Target Latitude and Longitude), a radar target's position can be output from the radar and marked on this plotter as the waypoint . For details, see the radar's operator's manual.

6. ROUTES

7. Select [COMMENT].
8. Enter the comment (see "How to enter alphanumeric data" on page 1-10).
9. Select [RUN] to show [RTE TRN PT LIST].

000001 RTE TRN PT LIST					SEL. PAGE _ 1/1	
	WPT		LATITUDE/LONGITUDE	DISTANCE	TTG	
1						
2						
3						
4						
5						
6						
7						
8						
9						
10						

WAYPOINTS LIST					SEL. PAGE _ 1/1	
NAME		LATITUDE/LONGITUDE	INT. BAN	COMMENT		
000001	●	33° 44.4762N 119° 00.7292W	0.00NM	10:00 1501.01		
000002	●	33° 43.7124N 118° 58.8938W	0.00NM	09:05 1501.01		
000003	●	33° 42.3050N 118° 57.3059W	0.00NM	09:05 1501.01		
000004	●	33° 40.5598N 118° 56.2006W	0.00NM	09:05 1501.01		
000005	●	33° 38.5330N 118° 55.2654W	0.00NM	09:05 1501.01		
000006	●	33° 36.9052N 118° 53.2233W	0.00NM	09:05 1501.01		
000007	●	33° 35.4199N 118° 50.9917W	0.00NM	09:05 1501.01		
000008	●	33° 33.1704N 118° 48.7842W	0.00NM	09:06 1501.01		
000009	●	33° 31.9381N 118° 44.6255W	0.00NM	09:06 1501.01		
000010	●	33° 29.3387N 118° 42.6100W	0.00NM	09:06 1501.01		

SORT		: ALPHA_ORD	RNG ORDER	
		MARK SHAPE	REG. ORDER	
SEARCH		: _____		
		---NM ---.M		

[0]~[9] : NO. OF PAGE ◀▶ : MOVE PAGE
 [CURSOR ON/OFF] : SKIP WPT
 [CANCEL] : DELETE WPT [MENU] : BACK

10. Push the **ENTER** knob to move the cursor to the waypoints list.

000001 RTE TRN PT LIST					SEL. PAGE _ 1/1	
	WPT		LATITUDE/LONGITUDE	DISTANCE	TTG	
1						
2						
3						
4						
5						
6						
7						
8						
9						
10						

WAYPOINTS LIST					SEL. PAGE _ 1/2▶	
NAME		LATITUDE/LONGITUDE	INT. BAN	COMMENT		
000001	●	33° 44.4762N 119° 00.7292W	0.00NM	10:00 1501.01		
000002	●	33° 43.7124N 118° 58.8938W	0.00NM	09:05 1501.01		
000003	●	33° 42.3050N 118° 57.3059W	0.00NM	09:05 1501.01		
000004	●	33° 40.5598N 118° 56.2006W	0.00NM	09:05 1501.01		
000005	●	33° 38.5330N 118° 55.2654W	0.00NM	09:05 1501.01		
000006	●	33° 36.9052N 118° 53.2233W	0.00NM	09:05 1501.01		
000007	●	33° 35.4199N 118° 50.9917W	0.00NM	09:05 1501.01		
000008	●	33° 33.1704N 118° 48.7842W	0.00NM	09:06 1501.01		
000009	●	33° 31.9381N 118° 44.6255W	0.00NM	09:06 1501.01		
000010	●	33° 29.3387N 118° 42.6100W	0.00NM	09:06 1501.01		

SORT		: ALPHA_ORD	RNG ORDER	
		MARK SHAPE	REG. ORDER	
SEARCH		: _____		

TURN KNOB ▲▼ : SELECT PUSH KNOB : ADD WPT
 [0]~[9] : NO. OF PAGE ◀▶ : MOVE PAGE
 [MENU] : BACK

11. Select a waypoint from the waypoint list. The preview for the selected waypoint is displayed at the bottom right of the screen.
 - When 11 or more waypoints are registered, use ◀ or ▶ to switch the page.
 - Waypoints are sorted in order of the selected search method. Select [SORT] then select a search method (see "How to search waypoints by search method" on page 5-8).
12. Repeat step 11 to complete the route.

13. Press the **MENU** key twice to return to [ROUTES LIST]. The total distance, number of waypoints, ETA and TTG are shown.

The screenshot shows the 'ROUTES LIST' menu with the following data:

NAME	COMMENT	TTL DIST	WPT QTY	SET AS DEST.
000001		7.79NM	5	

Additional menu options and information:

- BACK TRACK : DISTANCE TIME NO
- RNG LOG : 0 0 0 . 1 NM
- TIME LOG : 0 0 H 0 1 M
- SORT : ALPHA ORD (selected) RNG ORDER
- REG. ORDER
- SPD FOR : T SHP SPD 10.0kn
- TTG CALC : ENT VALU : 0 0 . 0 k n
- SEARCH : _____
- EST TIME OF ARR. : 2015/01/01 10:44
- TIME TO GO : 1Hrs36m

Annotations on the right side of the image:

- Number of waypoints (points to '5' in WPT QTY)
- Total distance from first waypoint to final waypoint (points to '7.79NM' in TTL DIST)
- Preview for final waypoint (points to the preview window showing waypoints 000002 to 000005)
- Estimated time of arrival (points to '2015/01/01 10:44')
- Time to go (points to '1Hrs36m')

Bottom status bar:

PUSH KNOB : EDIT ROUTE [WPT] : NEW WAYPOINT
 [CURSOR ON/OFF] : REVERSE RTE [GOTO] : SET DESTINATION
 [CANCEL] : DELETE ROUTE [MENU] : BACK

To set the route as your destination, press the **GOTO** key. [DST: FW] is displayed in [SET AS DEST.]. To follow the route in reverse waypoint order, press the **CURSOR ON/OFF** key. The indication [DIREC: FWD] changes [DIREC: REV] and the waypoint set as first waypoint is displayed in the preview window as final waypoint.

14. Press the **DISP** key to close the menu.

6.1.2 How to create track-based routes using own ship position

You can create routes based on your ship's track, by entering waypoints at own ship position, either manually or automatically. Track-based routes can have a maximum of 100 points. For automatic entry, you need to set an interval of time or distance. This feature is useful when you wish to retrace a track. The SAVE icon () appears at the bottom right of the screen when creating a track based route.

1. Press the **MENU** key to open the main menu.
2. Select [1. ROUTES/WAYPOINTS LIST].
3. Select [2. ROUTES LIST].
4. Select [RNG LOG] or [TIME LOG].
5. Press the numeric keys to enter range or time.
6. Select [BACK TRACK].
7. Select [DISTANCE] or [TIME]. Own ship position is automatically saved, at the interval selected, to use in creation of the route. The route name is automatically created.
8. Press the **DISP** key to close the menu.
9. To create the route manually, do the following:
 - 1) Press the **CURSOR ON/OFF** key to turn off the cursor.

6. ROUTES

- 2) Press the **WPT** key where you want to register the current own ship position as the waypoint. The message "ADDED WAYPOINT xxxxxx TO ROUTE XXXXXX." appears.
- 3) Press the **WPT** key where you want to change the course. The message same with the one in step 2 appears.

How to stop creating track-based routes

Follow the procedure below to stop creating a track-based route. Creation is automatically stopped when 100 waypoints have been entered, with the message "REACHED MAX. NO. OF WPTS REGISTERED IN A RTE." shown on the screen. Push the **ENTER** knob.

1. Press the **MENU** key to open the main menu.
2. Select [1. ROUTES/WAYPOINTS LIST].
3. Select [2. ROUTES LIST].
4. Select [BACK TRACK].
5. Select [NO].
6. Press the **DISP** key to close the menu.

6.1.3 How to create routes with selected tracks

You can create routes with the selected tracks of own ship or other ships.

1. Press the **MENU** key to open the main menu.
2. Select [5. MARK/TRACK EDIT/DELETE].
3. Select [7. TRACK ROUTE CONVERSION] to show the [TRACK ROUTE CONVERSION] window. Memory points for tracks are displayed with little squares.

TRACK ROUTE CONVERSION	
SEL. METH.	: BTWN 2PTS.
FILTER SET	
DISTANCE	: 0 0 0 . 0 0 0 NM
ANGLE	: 0 0 0 . 0 °
RUN CONV.	
NO OF DST TO CONV :	0/100
PLACE CURSOR AT START OF TRACK CONVERSION. PRESS KNOB TO CONFIRM.	

4. Select start memory point () to convert the route.
5. Select ending memory point () to convert the route.
6. Select [DISTANCE] in [FILTER SET].
7. Press the numeric keys to set the distance in order to filter the memory points for the route. Memory points that meet both of the following conditions are registered as waypoints for the route.
 - The distance between two track memory points is farther than the distance set here.
 - The angle between two track memory points is larger than the angle set at step 9.

8. Select [ANGLE] in [FILTER SET].
9. Press the numeric keys to set the angle filtered.
10. Select [RUN CONV.]. The number of points converted to waypoints is displayed.

TRACK ROUTE CONVERSION	
SEL. METH.	: BTWN 2PTS.
FILTER SET	
DISTANCE	: 0 0 0 . 5 0 0 NM
ANGLE	: 0 1 0 . 0 °
RUN CONV.	
NO OF DST TO CONV :	3/100
[WPT] : CHANGE TRACK PT TO WPT [CANCEL] : REVERT WPT TO TRACK PT [MENU] : BACK PUSH KNOB : CONVERT TO ROUTE	

- **WPT** key: If you want to convert a filtered memory point to a waypoint, select the memory point then press the **WPT** key.
 - **CANCEL** key: If you want to convert a filtered waypoint to a memory point, select the waypoint then press the **CANCEL** key.
11. Push the **ENTER** knob to show the following message.

	CONVERT THE TRACK TO ROUTE. ARE YOU SURE?
RUN	CANCEL

12. Select [RUN]. The converted waypoints are displayed on the screen. The waypoints are numbered from the youngest waypoint number among unused waypoints and displayed on the waypoints list. The converted route is displayed on the routes list. The route number is the smallest number among the unused route numbers.
13. Press the **DISP** key to close the menu.

6.2 How to Edit Routes

Note: When editing a route which is in use as a destination, stop navigation (see section 7.4) before editing.

6.2.1 How to insert waypoints

You can newly insert waypoints to a registered route.

1. Press the **MENU** key to open the main menu.
2. Select [1. ROUTES/WAYPOINTS LIST].
3. Select [2. ROUTES LIST].
4. Select the route to process, and the [ROUTE NAME/ENTER COMMENT] window appears.
5. Select [RUN] to show [RTE TRN PT LIST].
6. On the list, select where to insert the waypoint.
 - **Insert waypoint between existing waypoints:** Put the cursor on the waypoint which will follow the waypoint to be inserted.
 - **Insert waypoint at the end of route:** Select first blank line.

The cursor shifts to the waypoints list.

6. ROUTES

7. Select the waypoint to insert. The waypoint is inserted at the selected location.
Note: To correct an error, press the **MENU** key to move the cursor to [RTE TRN PT LIST]. Select the waypoint to remove, then press the **CANCEL** key.
8. Press the **DISP** key to close the menu.

6.2.2 How to delete waypoints from routes

1. Press the **MENU** key to open the main menu.
2. Select [1. ROUTES/WAYPOINTS LIST].
3. Select [2. ROUTES LIST].
4. Select the route to process, and the [ROUTE NAME/ENTER COMMENT] window appears.
5. Select [RUN] to show [RTE TRN PT LIST].
6. Select the waypoint to delete, then press the **CANCEL** key.
7. Press the **DISP** key to close the menu.

6.3 How to Delete Routes

1. Press the **MENU** key to open the main menu.
2. Select [1. ROUTES/WAYPOINTS LIST].
3. Select [2. ROUTES LIST].
4. Select the route to delete, then press the **CANCEL** key. The following message appears.

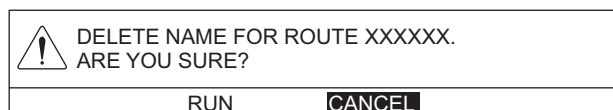

5. Select [RUN] to delete the route.
6. Press the **DISP** key to close the menu.

6.4 How to Search Routes

You can search routes by sort method (alphanumeric order, distance to own ship, registration order), or route name.

How to search routes by search method

1. Press the **MENU** key to open the main menu.
2. Select [1. ROUTES/WAYPOINTS LIST].
3. Select [2. ROUTES LIST].
4. Select [SORT].
5. Select the search method.
[ALPHA. ORD]: Sorts routes in order of numbers, alphabets.
[RNG ORDER]: Sorts routes in order of increasing distance to own ship.
[REG. ORDER]: Sorts routes in order of registration. The last-registered route is at the top of the list.
6. Press the **DISP** key to close the menu.

How to search by route name

1. Press the **MENU** key to open the main menu.
2. Select [1. ROUTES/WAYPOINTS LIST].
3. Select [2. ROUTES LIST].
4. Select [SEARCH] to show the [SEARCH] window.
5. Enter the first three characters of the route name (see "How to enter alphanumeric data" on page 1-10) then select [ENTER]. The appropriate route is displayed at the top of the routes list.
6. Press the **DISP** key to close the menu.

6.5 How to Set the Speed to Use in TTG Calculation

Calculation of TTG is based on ship's speed data. Speed can be set manually or automatically.

1. Press the **MENU** key to open the main menu.
2. Select [1. ROUTES/WAYPOINTS LIST].
3. Select [2. ROUTES LIST].
4. Select [SPD FOR TTG CALC].
5. Select [T. SHP SPD] or [ENT VALU].
[T. SHP SPD]: Calculate TTG with the actual ship's speed. Go to step 7.
[ENT VALU]: Calculate TTG with manually entered speed. Go to step 6.
6. Press the numeric keys to enter speed.
7. Highlight the route on the routes list to show its TTG ([TIME TO GO]) and ETA ([EST TIME OF ARR.]) at the bottom right of the screen.
8. Press the **DISP** key to close the menu.

6. ROUTES

This page is intentionally left blank.

7. DESTINATION

This chapter shows you how to get to a desired destination, using “quick points,” waypoints, and routes.

7.1 How to Go to a Quick Point

The quick point feature allows you to navigate to point(s) without retaining the data in the internal memory. Each time a quick point is entered, previous quick points having the same numbers as newly entered ones are written over.

How to select the quick point entry method

You can select the quick point entry method: single point or multiple points (up to 100 points).

1. Press the **MENU** key to open the main menu.
2. Select [0. SYSTEM SETTING].
3. Select [1. DISPLAY FORMAT].
4. Select [SET GOTO METHOD] on page 3.

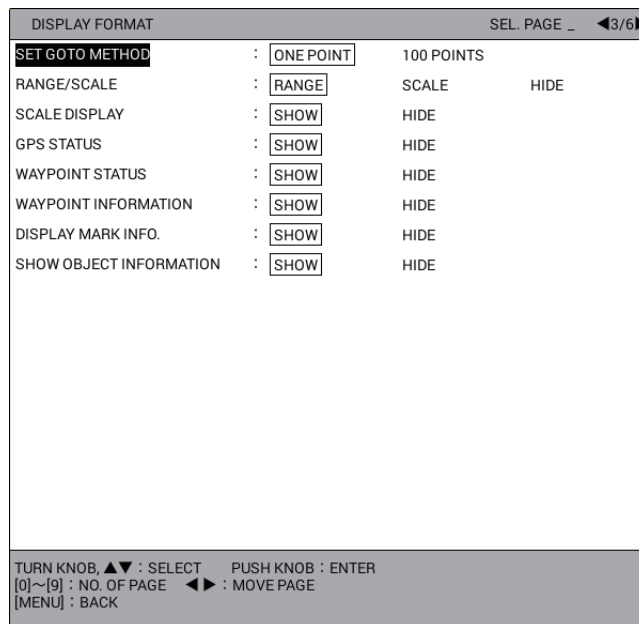

5. Select [ONE POINT] or [100 POINTS].
[ONE POINT]: Sets a single quick point as a waypoint.
[100 POINTS]: Sets multiple quick points (up to 100) as a route.
6. Press the **DISP** key to close the menu.

How to navigate to a single quick point

1. Set the quick point entry method to [ONE POINT], referring to "How to select the quick point entry method" on page 7-1.
2. Show the plotter display with NAV information (see section 1.4.2 and section 2.1.2).
3. Press the **CURSOR ON/OFF** key to turn on the cursor.
4. Put the cursor where you want to enter the quick point, then press the **GOTO** key.

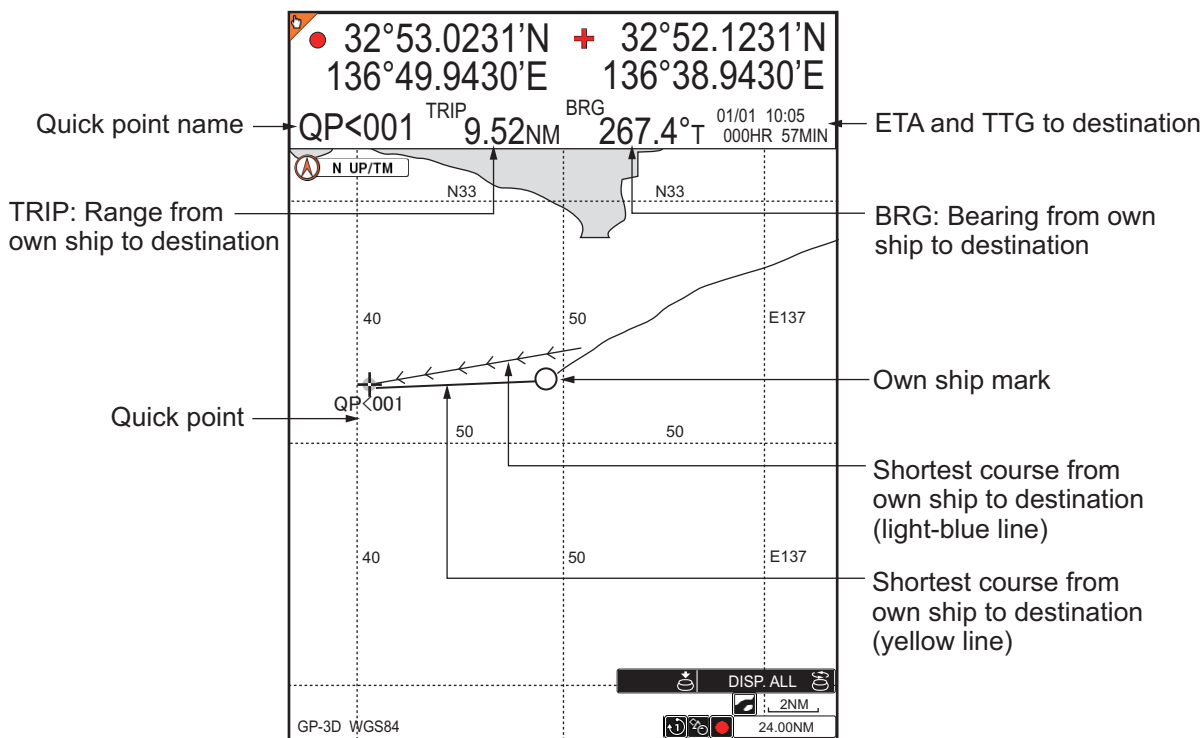

The quick point (destination) is marked and named "QP<001". Light-blue and yellow lines connect the own ship with the destination, and these lines show the shortest course to the destination. Arrows on the line show the direction to follow to get to the destination. The light-blue line does not move from where it was set, regardless of ship movement. The yellow line moves according to the movement of own ship. When selecting [DISTANCE TO WAYPOINT], [BEARING TO WAYPOINT], [WAYPOINT ETA, TTG] for destination information, range and bearing from own ship to the destination, ETA and TTG to the destination appear on the NAV information box. The location is saved to the waypoints list, under the name "QP<001".

Note 1: Each time a quick point is entered, previous quick points having the same numbers as newly entered ones are written over.

Note 2: If waypoint data (L/L position) is received from an external navigator while navigating to a quick point, the quick point is erased and the received waypoint becomes the destination.

How to navigate a quick point route

1. Set the quick point entry method to [100 POINTS], referring to "How to select the quick point entry method" on page 7-1.
2. Show the plotter display with NAV information (see section 1.4.2 and section 2.1.2).
3. Press the **CURSOR ON/OFF** key to turn on the cursor.
4. Press the **GOTO** key to show the [CREATE QUICK ROUTE] window.
5. Put the cursor where you want to enter the first quick point (registered waypoint or new point), then push the **ENTER** knob. The symbol and name for the selected waypoint turn yellow. When entering a new point, it is named "QP<001".
6. Repeat step 5 to complete the route (up to 100 waypoints). A yellow line connects the selected waypoints each other. To delete the last-set waypoint, press the **CANCEL** key.
7. To complete the route, push the **ENTER** knob twice at the final quick point.

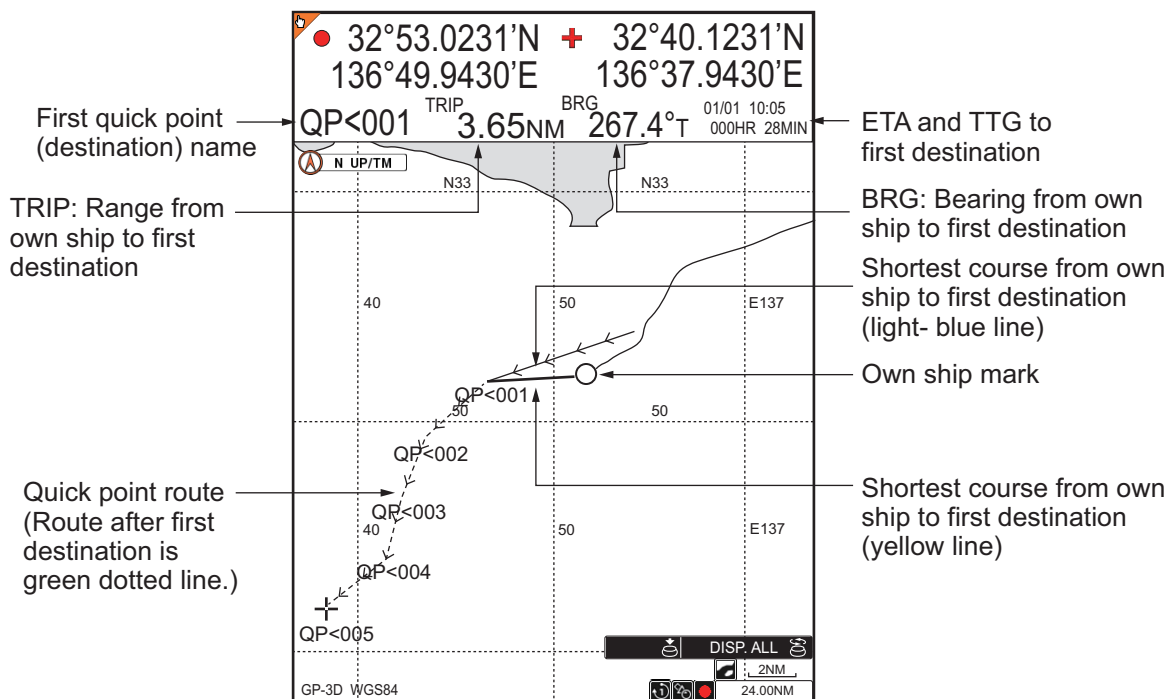

Light-blue and yellow lines connect the own ship with the first destination, and green dotted lines connect between other waypoints. These lines show the shortest course to the destination. Arrows on the line show the direction to follow to get to the destination. The light-blue line does not move from where it was set, regardless of ship movement. The yellow line moves according to the movement of own ship. When selecting [DISTANCE TO WAYPOINT], [BEARING TO WAYPOINT], [WAYPOINT ETA, TTG] for destination information, range and bearing from own ship to the first destination, ETA and TTG to the first destination appear on the NAV information box. The route is saved to the routes list, under the name "Q<RTE".

Note: Each time a quick point route is entered, previous quick point route is written over. When entering a new quick waypoint, "QP<001" is removed from the "Q<RTE".

7.2 How to Set a Waypoint as Destination

There are four methods to set a waypoint as destination.

- Set a waypoint as destination on the plotter display.
- Set a waypoint as destination from the waypoints list.
- Set a waypoint as destination with a waypoint number.
- Set a waypoint as destination from the waypoint log.

How to set a waypoint as destination on the plotter display

1. Set the quick point entry method to [ONE POINT], referring to "How to select the quick point entry method" on page 7-1.
2. Show the plotter display with NAV information (see section 1.4.2 and section 2.1.2).
3. Press the **CURSOR ON/OFF** key to turn on the cursor.
4. Put the cursor on the waypoint to set as the destination, then press the **GOTO** key.

Light-blue and yellow lines connect the own ship with the destination. The light-blue line does not move from where it was set, regardless of ship movement. The yellow line moves according to the movement of own ship. When selecting [DISTANCE TO WAYPOINT] and [BEARING TO WAYPOINT] for destination information, range and bearing from own ship to the destination appear on the NAV information box.

How to set a waypoint as destination from the waypoints list

1. Press the **MENU** key to open the main menu.
2. Select [1. ROUTES/WAYPOINTS LIST].
3. Select [1. WAYPOINTS LIST].
4. Select the waypoint to set as the destination, then press the **GOTO** key. The indication "SET DEST.: WPT XXXXXX" appears below the title [WAYPOINTS LIST].
5. Press the **DISP** key to close the menu.

Light-blue and yellow lines connect the own ship with the destination. The light-blue line does not move from where it was set, regardless of ship movement. The yellow line moves according to the movement of own ship. When selecting [DISTANCE TO WAYPOINT] and [BEARING TO WAYPOINT] for destination information, range and bearing from own ship to the destination appear on the NAV information box.

How to set a waypoint as destination with a waypoint number

1. Press the **CURSOR ON/OFF** key to turn off the cursor.
2. Press the **GOTO** key to show the [SELECT WP] window.

[SELECT WP] window →

SELECT WP				
ENTER WP NO : 0 0 0 0 0 0				
WP LOG				
NAME		LATITUDE/LONGITUDE	INT. BAN	COMMENT
000007	●	33° 35.4199'N 118° 50.9917'W	0.00NM	09:05 1501.01
000001	●	33° 44.4762'N 119° 00.7292'W	0.00NM	10:00 1501.01
TO SET A DESTINATION: ENTER POINT NO. OR ROTATE KNOB TO SELECT POINT THEN PRESS KNOB TO CONFIRM.				

Note: The [SELECT WP] window closes automatically when there is no operation for 10 seconds.

3. Press the numeric keys to enter the waypoint number to set as the destination then push the **ENTER** knob.

Light-blue and yellow lines connect the own ship with the destination. The light-blue line does not move from where it was set, regardless of ship movement. The yellow line moves according to the movement of own ship. When selecting [DISTANCE TO WAYPOINT] and [BEARING TO WAYPOINT] for destination information, range and bearing from own ship to the destination appear on the NAV information box.

How to set a waypoint as destination from the waypoint log

Up to 10 waypoints last-set as destinations are registered on the waypoint log. To set a waypoint among these waypoints as the destination, do the following. When the waypoint log memory becomes full, the oldest waypoint is erased to make room for the latest.

1. Press the **CURSOR ON/OFF** key to turn off the cursor.
2. Press the **GOTO** key to show the [WP LOG] window.

[WP LOG] window →

SELECT WP				
ENTER WP NO : 0 0 0 0 0 0				
WP LOG				
NAME		LATITUDE/LONGITUDE	INT. BAN	COMMENT
000007	●	33° 35.4199'N 118° 50.9917'W	0.00NM	09:05 1501.01
000001	●	33° 44.4762'N 119° 00.7292'W	0.00NM	10:00 1501.01
TO SET A DESTINATION: ENTER POINT NO. OR ROTATE KNOB TO SELECT POINT THEN PRESS KNOB TO CONFIRM.				

Note: The [WP LOG] window closes automatically when there is no operation for 10 seconds.

3. Select the waypoint to set as the destination from the waypoint log.

7. DESTINATION

Light-blue and yellow lines connect the own ship with the destination. The light-blue line does not move from where it was set, regardless of ship movement. The yellow line moves according to the movement of own ship. When selecting [DISTANCE TO WAYPOINT] and [BEARING TO WAYPOINT] for destination information, range and bearing from own ship to the destination appear on the NAV information box.

7.3 How to Follow Routes

How to set a route as destination

1. Press the **MENU** key to open the main menu.
2. Select [1. ROUTES/WAYPOINTS LIST].
3. Select [2. ROUTES LIST].
4. Select the route to set as destination then press the **CURSOR ON/OFF** key to switch the direction to follow the route. The direction selected is indicated below the title [ROUTES LIST] as [DIREC: FWD] or [DIREC: REV].
[DIREC: FWD]: Follow the route in the order its waypoints were entered.
[DIREC: REV]: Follow the route in order of last waypoint to first waypoint.
5. Press the **GOTO** key to set the route as destination. The indication [DST: RV] or [DST: FW] appears in [SET AS DEST].

ROUTES LIST					SEL. PAGE _ 1/1
DIREC: FWD					
NAME	COMMENT	TTL DIST	WPT QTY	SET AS DEST.	
000001	ROUTE 1	21.23NM	5	DST: FW	

Forward order

ROUTES LIST					SEL. PAGE _ 1/1
DIREC: REV					
NAME	COMMENT	TTL DIST	WPT QTY	SET AS DEST.	
000001	ROUTE 1	21.23NM	5	DST: RV	

Reverse order

6. Press the **DISP** key to close the menu.

Light-blue and yellow lines connect the own ship with the first destination, and green dotted lines connect between other waypoints. The light-blue line does not move from where it was set, regardless of ship movement. The yellow line moves according to the movement of own ship. When own ship arrives at the first destination, the green dotted line to the next destination becomes light-blue solid line. When selecting [DISTANCE TO WAYPOINT] and [BEARING TO WAYPOINT] for destination information, range and bearing from own ship to the first destination appear on the NAV information box.

How to skip waypoints in a route

In some instances you may want to skip waypoints while following a route. In the figure below, for example, the vessel has decided to navigate from waypoint 05 to 03, skipping waypoint 04.

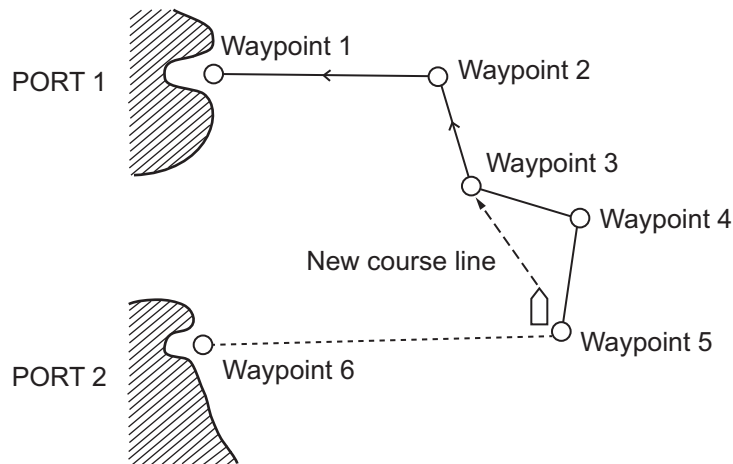

1. Press the **MENU** key to open the main menu.
2. Select [1. ROUTES/WAYPOINTS LIST].
3. Select [2. ROUTES LIST].
4. Select the route to change. The [ROUTE NAME/ENTER COMMENT] window appears.
5. Select [RUN] to display [RTE TRN PT LIST].
6. Select the waypoint to skip then press the **CURSOR ON/OFF** key. "-" appears in [DISTANCE], [TTG] and a field before [WPT].

000001 RTE TRN PT LIST					SEL_PAGE _ 1/1	
	WPT		LATITUDE/LONGITUDE	DISTANCE	TTG	
1	000001	●	33° 44.4762'N 119° 00.7292'W	0.00NM	00D00H00M	
2	000002	●	33° 43.7124'N 118° 58.8938'W	1.71NM	00D00H10M	
3	000007	●	33° 35.4199'N 118° 50.9917'W	—NM	—D—H—M	
4	000004	●	33° 40.5598'N 118° 56.2006'W	5.58NM	00D00H33M	
5	000005	●	33° 38.5330'N 118° 55.2654'W	7.76NM	00D00H46M	
6						
7						
8						
9						
10						

Note: To restore a waypoint, select it then press the **CURSOR ON/ OFF** key.

7. Press the **DISP** key to close the menu.

How to select the waypoint switching method

When your vessel arrives at a waypoint, the waypoint is automatically switched to the next sequential waypoint. You can select the switching method from [WPT ON VERTICAL LINE] or [ARRIVE ALARM WITHIN RANGE].

[WPT ON VERTICAL LINE]: Automatically switches the waypoint to the next sequential waypoint when the vessel enters the arrival alarm area or the vessel passes an imaginary perpendicular line passing through the center of the destination waypoint. For how to set the arrival alarm area, see chapter 8.

[ARRIVE ALARM WITHIN RANGE]: Automatically switches the waypoint to the next sequential waypoint when your vessel is within the arrival alarm area.

7. DESTINATION

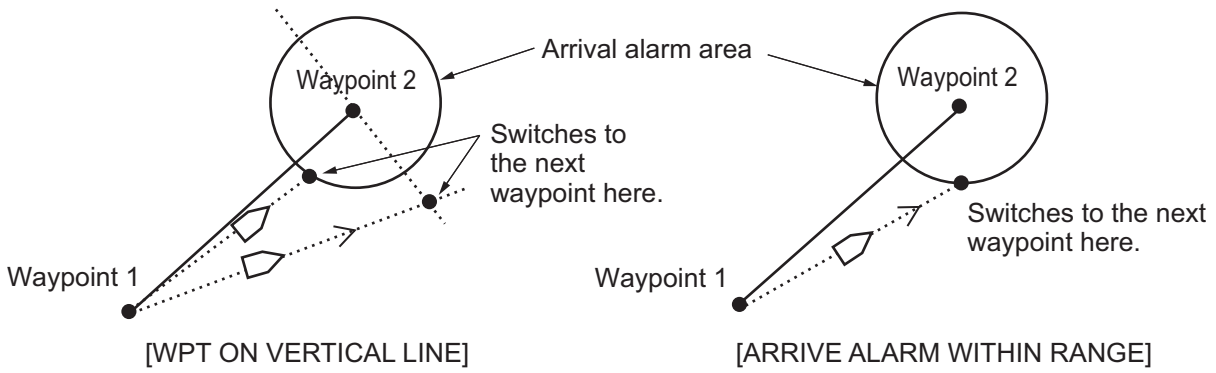

1. Press the **MENU** key to open the main menu.
2. Select [0. SYSTEM SETTING].
3. Select [1. DISPLAY FORMAT].
4. Select [WPT.REFRESH SETTING] on page 2.
5. Select [WPT ON VERTICAL LINE] or [ARRIVE ALARM WITHIN RANGE].
6. Press the **MENU** key to close the menu.

7.4 How to Stop Navigation

1. Press the **GOTO** key to show the following message.

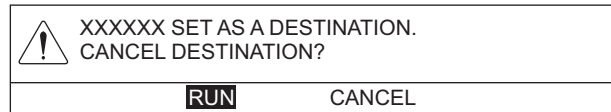

2. Select [RUN] to stop navigation.

8. ALARMS

This unit has 20 alarms which alert you with audio and visual alarms.

- Arrival
- Cross-track error (XTE)
- Ship speed
- AIS proximity
- External AIS
- Depth
- Fish (individual)
- Anchor watch
- Border
- Trip range
- CPA/TCPA
- Water temp.
- Fish (normal)
- Bottom discrimination (seabed composition)
- Route
- Intrusion point
- AIS auto activation
- AIS lost
- Shear
- Fish (bottom lock)

When an alarm setting is violated, the buzzer sounds and the alarm icon and alarm type appear at the bottom of the screen. You may silence the buzzer by pressing the **CANCEL** key. The icon remains on the screen until the cause of the alarm is removed or the alarm is deactivated. When an alarm setting occurs again, the buzzer sounds and the alarm icon appears. For the alarms of fish (normal), fish (bottom lock), fish (individual) and bottom discrimination, see section 11.17.

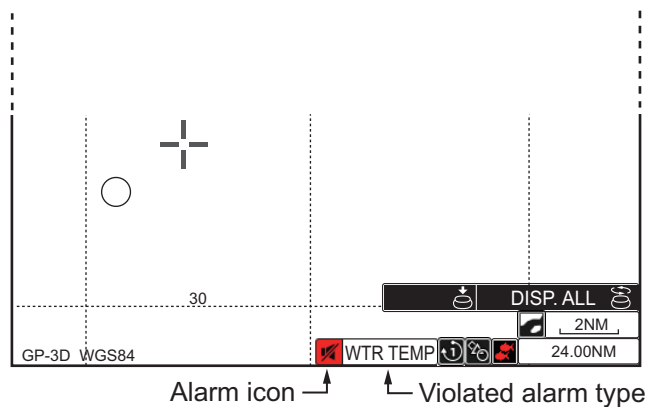

Note: When multiple alarms occur, violated alarm types alternately appear at the bottom of the display.

8.1 How to Turn the Audio Alarm On/Off

The audio alarm sounds whenever an alarm setting is violated. You can enable or disable the audio alarm as follows:

1. Press the **MENU** key to open the main menu.
2. Select [6. ALARM SETTINGS].
3. Select [ALARM PATTERN] on page 1.

ALARM SETTINGS		SEL. PAGE	1/4 ▶
ALARM PATTERN	: SHORT BEEP LONG BEEP		
	<input type="checkbox"/> CONTINUOUS BEEP ---		
	RESET		
ARRIVAL ALARM	: ON <input type="checkbox"/> OFF		
ALARM RANGE	: 0. 0 5 0 NM		
AUTO CANCEL	: <input type="checkbox"/> YES NO		
ANCHOR WATCH ALARM	: ON <input type="checkbox"/> OFF		
ALARM RANGE	: 0. 0 5 0 NM		
ROUTE ALARM SETTING	: ON <input type="checkbox"/> OFF		
XTE/BORDER ALARM	: OFF COURSE INTRUSION <input type="checkbox"/> OFF		
ALARM RANGE	: 0. 0 5 0 NM		
INTRUSION POINT ALM	: ON <input type="checkbox"/> OFF		
SHIP SPEED ALARM	: WITHIN RANGE OUT OF RANGE <input type="checkbox"/> OFF		
MINIMUM SHIP SPEED	: 0 0 0. 0 k n		
MAXIMUM SHIP SPEED	: 0 3 0. 0 k n		
TURN KNOB, ▲▼ : SELECT PUSH KNOB : ENTER			
[0]~[9] : NO. OF PAGE ◀▶ : MOVE PAGE			
[MENU] : BACK			

4. Select the audio alarm type.
 - [SHORT BEEP]: Three beeps sound.
 - [LONG BEEP]: Six beeps sound.
 - [CONTINUOUS BEEP]: Continuous beeps sound.
 - [RESET]: Audio alarm off.
5. Press the **DISP** key to close the menu.

8.2 Arrival, Anchor Watch Alarm

The **arrival alarm** informs you that your vessel is approaching a destination waypoint. The area that defines an arrival zone is that of a circle which you approach from the outside of the circle. The alarm will be released if your vessel enters the circle. When the arrival alarm is active, a red dashed circle marks the arrival alarm area.

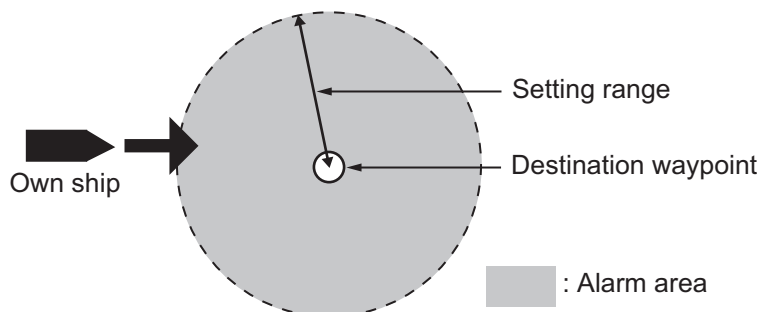

The **anchor watch alarm** informs you that your vessel is moving when it should be at rest. When the anchor watch is active, a orange dashed circle marks the anchor watch area.

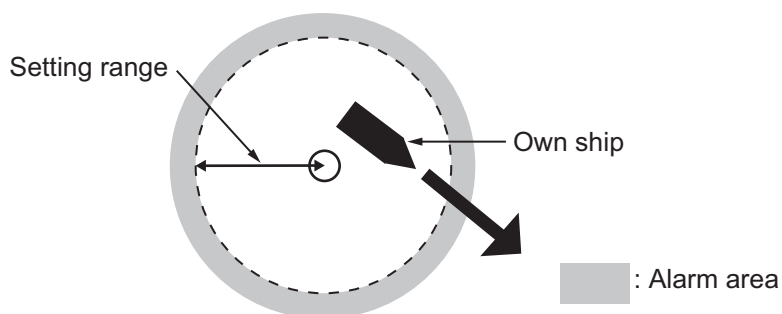

1. Press the **MENU** key to open the main menu.
2. Select [6. ALARM SETTINGS].
3. Select [ARRIVAL ALARM] or [ANCHOR WATCH ALARM] on page 1.
4. Select [ON].
5. Select [ALARM RANGE].
6. Press the numeric keys to set the alarm range (setting range: 0.001 to 9.999 NM).
7. Press the **DISP** key to close the menu.
8. For the anchor watch alarm, put the cursor on the own ship position or the location around own ship, then press the **GOTO** key. The orange dashed circle showing the alarm area appears. The alarm sounds when your vessel goes out of this area.

To deactivate an alarm, select [OFF] at step 4. If [ALARM PATTERN] is set to [CONTINUOUS BEEP] and [AUTO CANCEL] is set to [YES], the alarm sounds for 10 seconds when your ship arrives at the destination (or goes out of the anchor watch alarm radius) and then automatically stops. If you want the alarm to sound continuously, until the **CANCEL** key is pressed or the conditions of alarm are no longer met, set [AUTO CANCEL] to [NO].

8.3 Route Alarm

The **route alarm** sets an anchor watch alarm on each route point (waypoint) in the route in use. When your vessel goes out of the anchor watch alarm range at a route point, the audio alarm sounds. To use this alarm, [ANCHOR WATCH ALARM] must be set to [ON] (see section 8.2).

1. Press the **MENU** key to open the main menu.
2. Select [6. ALARM SETTINGS].
3. Select [ROUTE ALARM SETTING] on page 1.
4. Select [ON]. When your vessel goes out of the alarm range at a route point, the audio alarm sounds. If selecting [OFF], the anchor watch alarm alerts you when your vessel goes out of the alarm range at the last waypoint in the route.
5. Press the **DISP** key to close the menu.

To deactivate an alarm, select [OFF] at step 4.

8.4 XTE, Border Alarm

The **XTE (cross track error) alarm** warns you when your vessel is off its intended course. When the XTE alarm is active, two red dashed lines mark the XTE alarm area.

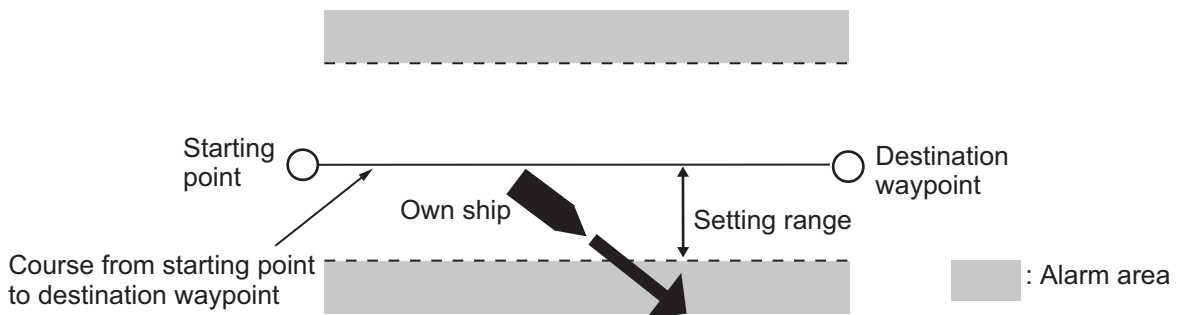

The **border alarm** marks an area, defined by two waypoints, which you do not want to cross. The audio and visual alarms will be released when your vessel crosses the area defined by the two waypoints. When the border alarm is active, the red dashed lines mark on either side of the setting line.

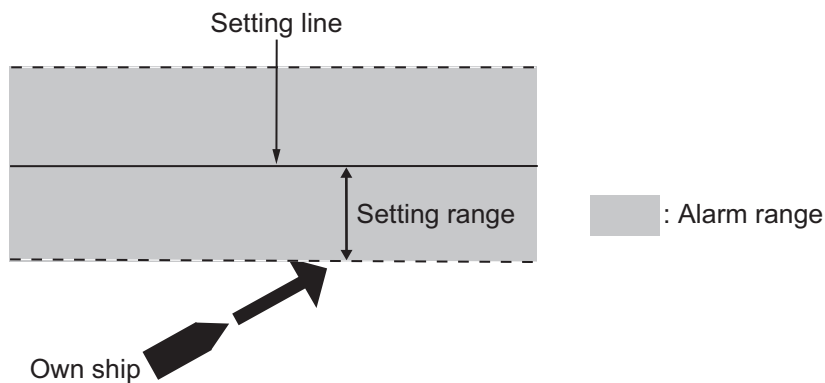

Note: The XTE and border alarm cannot be turned on together.

1. Press the **MENU** key to open the main menu.
2. Select [6. ALARM SETTINGS].

3. Select [XTE/BORDER ALARM] on page 1.
4. Select [OFF COURSE] or [INTRUSION].
5. Select [ALARM RANGE].
6. Press the numeric keys to set the alarm range (setting range: 0.001 to 9.999 NM).
7. Press the **DISP** key to close the menu.

To deactivate an alarm, select [OFF] at step 4.

8.5 Intrusion Point Alarm

The **intrusion point alarm** alerts you when your vessel nears a waypoint by the distance set for that waypoint on the waypoints list. The distance is called the intrusion ban alarm radius (see section 5.1.3). When the intrusion point alarm is active, a red dashed circle marks the intrusion ban alarm radius.

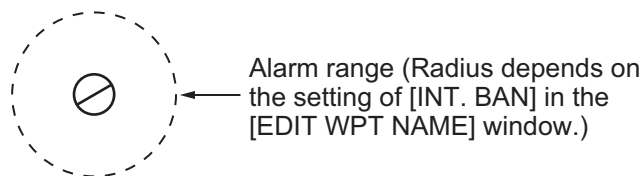

1. Press the **MENU** key to open the main menu.
2. Select [6. ALARM SETTINGS].
3. Select [INTRUSION POINT ALM] on page 1.
4. Select [ON].
5. Press the **DISP** key to close the menu.

To deactivate an alarm, select [OFF] at step 4.

8.6 Ship Speed Alarm

The ship speed alarm warns you when your boat's speed is within or over the speed range set.

1. Press the **MENU** key to open the main menu.
2. Select [6. ALARM SETTINGS].
3. Select [SHIP SPEED ALARM] on page 1.
4. Select [WITHIN RANGE] or [OUT OF RANGE].
5. Select [MINIMUM SHIP SPEED].
6. Press the numeric keys to enter the minimum ship speed (setting range: 0 to 999.9 kn).
7. Select [MAXIMUM SHIP SPEED].
8. Press the numeric keys to enter the maximum ship speed (setting range: 0 to 999.9 kn).
9. Press the **DISP** key to close the menu.

To deactivate an alarm, select [OFF] at step 4.

8.7 Trip Range Alarm

The trip range alarm informs you when you have traveled a certain distance.

1. Press the **MENU** key to open the main menu.
2. Select [6. ALARM SETTINGS].
3. Select [TRIP RANGE ALARM] on page 2.
4. Select [ON].
5. Select [ALARM RANGE].
6. Press the numeric keys to enter the alarm range (setting range: 0.1 to 9999.9 NM).
7. Press the **DISP** key to close the menu.

To deactivate an alarm, select [OFF] at step 4.

How to reset the trip range

1. Press the **MENU** key to open the main menu.
2. Select [6. ALARM SETTINGS].
3. Select [TRIP RANGE RESET] on page 2 to show the following message.

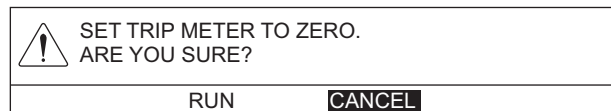

4. Select [RUN] to reset the trip range.
5. Press the **DISP** key to close the menu.

8.8 Water Temperature Alarm

The water temperature alarm requires a water temperature sensor, and comes in two types: [WITHIN RANGE] and [OUT OF RANGE]. The [WITHIN RANGE] alarm sounds when the water temperature is within the range set, and the [OUT OF RANGE] alarm sounds when the water temperature is higher or lower than the range set.

1. Press the **MENU** key to open the main menu.
2. Select [6. ALARM SETTINGS].

3. Select [WATER TEMP. ALARM] on page 2.

ALARM SETTINGS		SEL. PAGE	◀2/4▶
TRIP RANGE ALARM	: ON	[OFF]	
ALARM RANGE	: 0 0 0 0. 1 NM		
TRIP RANGE RESET			
AIS AUTO ACTIVATION	: [ON]	OFF	
ACTIVATION RANGE	: 0 2. 0 NM		
IGNORE MOORED SHIPS	: [IGNORE]	SHOW	
MAX. SPD FOR MOORED	: 0 1. 0 k n		
AIS PROXIMITY ALARM	: ON	[OFF]	
ALARM RANGE	: 0 1. 0 NM		
CPA/TCPA ALARM	: ON	[OFF]	
CPA ALARM RANGE	: 0 1. 0 NM		
TCPA ALARM RANGE	: 0 0 M. 3 0 S.		
AIS LOST ALARM	: ON	[OFF]	
LOST DEL. TIME	: 0 3 0 S.		
EXTERNAL AIS ALARM	: ON	[OFF]	
WATER TEMP. ALARM	: WITHIN RANGE	OUT OF RANGE	[OFF]
LOWEST WATER TEMP.	: + 3 0. 0 °F		
HIGHEST WATER TEMP.	: + 8 5. 0 °F		
TURN KNOB, ▲▼ : SELECT PUSH KNOB : ENTER			
[0]~[9] : NO. OF PAGE ◀▶ : MOVE PAGE			
[MENU] : BACK			

4. Select [WITHIN RANGE] or [OUT OF RANGE].
5. Select [LOWEST WATER TEMP.].
6. Press the numeric keys to enter the minimum temperature (setting range: -99.9 to +99.9°F).
7. Select [HIGHEST WATER TEMP.].
8. Press the numeric keys to enter the maximum temperature (setting range: -99.9 to +99.9°F).
9. Press the **DISP** key to close the menu.

To deactivate an alarm, select [OFF] at step 4.

8.9 Shear Alarm

The shear alarm, which requires a water temperature sensor, sounds when the water temperature goes higher or lower than the preset value within the interval time set.

1. Press the **MENU** key to open the main menu.
2. Select [6. ALARM SETTINGS].
3. Select [SHEAR ALARM] on page 3.
4. Select [ON].
5. Select [VARIATION RANGE].
6. Press the numeric keys to enter the gradient of temperature (setting range: 0.1 to 10.0).
7. Select [DETECTION INTERVAL].
8. Press the numeric keys to enter the interval (setting range: 10 to 120 seconds).
9. Press the **DISP** key to close the menu.

To deactivate an alarm, select [OFF] at step 4.

8.10 Depth Alarm

The depth alarm sounds when the bottom echo is within the alarm range set.

1. Press the **MENU** key to open the main menu.
2. Select [6. ALARM SETTINGS].
3. Select [DEPTH ALARM] on page 3.

ALARM SETTINGS		SEL. PAGE _ ◀3/4▶
SHEAR ALARM	: ON	<input type="checkbox"/> OFF
VARIATION RANGE	: 00. 2	(0.1 to 10.0)
DETECTION INTERVAL	: 0 1 0 S.	(10 to 120)
DEPTH ALARM	: ON	<input type="checkbox"/> OFF
STARTING DEPTH	: 0000. 0 f t	
WIDTH	: 0000. 0 f t	
FISH ALARM (NORMAL)	: ON	<input type="checkbox"/> OFF
STARTING DEPTH	: 0000. 0 f t	
WIDTH	: 0000. 0 f t	
FISH ALM (BTM LOCK)	: ON	<input type="checkbox"/> OFF
STARTING DEPTH	: 00. 0 f t	
WIDTH	: 00. 0 f t	
FISH ALARM	: ON	<input type="checkbox"/> OFF
FISH SIZE	: 005. 0 i n c h	

TURN KNOB, ▲▼ : SELECT PUSH KNOB : ENTER
 [0]~[9] : NO. OF PAGE ◀▶ : MOVE PAGE
 [MENU] : BACK

4. Select [ON].
5. Select [STARTING DEPTH].
6. Press the numeric keys to enter the start depth (setting range: 0 to 4000 ft).
7. Select [WIDTH].
8. Press the numeric keys to enter the alarm range (setting range: 0 to 4000 ft).
9. Press the **DISP** key to close the menu.

To deactivate an alarm, select [OFF] at step 4.

9. OTHER FUNCTIONS

This chapter describes the various options which allow you to set up your unit to suit your needs.

9.1 [COAST LINE SETTING] Menu

The [COAST LINE SETTING] menu has three menus: [COAST LINE DETAIL SETTING], [CONTOUR LINE FINE RNG SETTINGS] and [INDIVIDUAL CONTOUR LINE SETTINGS].

9.1.1 [COAST LINE DETAIL SETTING] menu

1. Press the **MENU** key to open the main menu.
2. Select [7. COAST LINE SETTING].
3. Select [1. COAST LINE DETAIL SETTING] which has three pages.
4. Select an item to change.
5. Select an option.
6. After setting all required items, press the **DISP** key to close the menu.

The description for each item is as shown below.

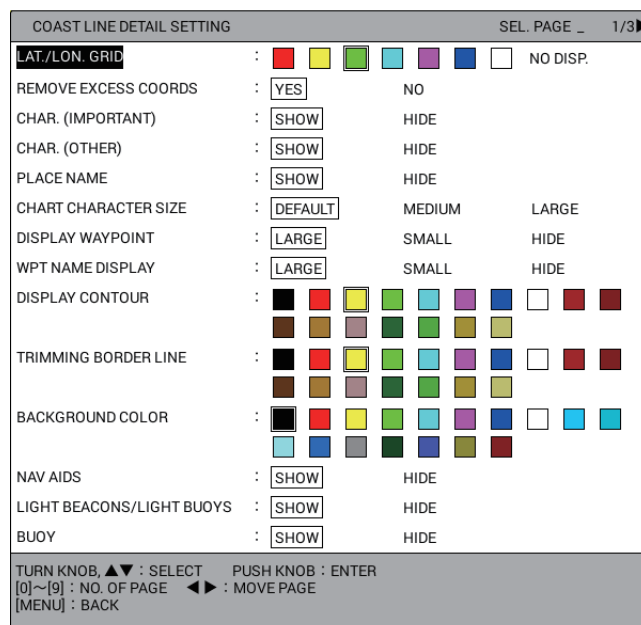

[COAST LINE DETAIL SETTING] menu: Page 1

[LAT./LON. GRID]: Turns latitude/longitude grid on or off and changes its color from seven colors.

[REMOVE EXCESS COORDS]: Choose how often to show the latitude and longitude numerical indication on the latitude and longitude grid. [YES] shows the numerical information every other grid. [NO] shows all grid information.

[CHAR. (IMPORTANT)]: Turns important text on or off.

9. OTHER FUNCTIONS

[CHAR. (OTHER)]: Turns other text on or off.

[PLACE NAME]: Turns geographical name on or off.

[CHART CHARACTER SIZE]: Set the size of characters other than the depth. Select [DEFAULT] to show the information with the smallest characters, which is the default setting. Select [MEDIUM] to show the information with bigger characters. Select [LARGE] to show the information with the largest characters.

[DISPLAY WAYPOINT]: Turns waypoint on or off and selects size to large or small (see section 5.7).

[WPT NAME DISPLAY]: Turns waypoint name on or off and selects size to large or small on the plotter display. The waypoint name is displayed in the color same as waypoint mark.

[DISPLAY CONTOUR]: Selects color for land from 17 colors.

[TRIMMING BORDER LINE]: Selects color for edge from 17 colors.

[BACKGROUND COLOR]: Selects color for background from 17 colors.

[NAV AIDS]: Displays the navigation data set to [SHOW] from [LIGHT BEACONS/LIGHT BUOYS] (on page 1) to [TIDAL STATION] (on page 3) when selecting [SHOW]. Displays no navigation data regardless of each setting when selecting [HIDE].

[LIGHT BEACONS/LIGHT BUOYS], [BUOY], [CONTOUR LINES/TIDAL CURRENT]: Turns each mark on or off.



COAST LINE DETAIL SETTING		SEL. PAGE	◀2/3▶
CONTOUR LINES/TIDAL CURRENT	: SHOW	HIDE	
LANDMARKS	: SHOW	HIDE	
OBSTACLES	: SHOW	HIDE	
OBSTACLES IN A SAFE AREA	: SHOW	HIDE	
FISHING EQUIPMENT	: SHOW	HIDE	
SEABED COMPOSITION	: SHOW	HIDE	
WATER QUALITY	: SHOW	HIDE	
ALARM AREA	: SHOW	HIDE	
LIGHT SECTOR	: SHOW	HIDE	
MOUNTAINTOP	: SHOW	HIDE	
LANDSCAPE	: SHOW	HIDE	
FOG SIGNAL	: SHOW	HIDE	
SIGNALS	: SHOW	HIDE	
SERVICE	: SHOW	HIDE	
HARBOR FACILITIES	: SHOW	HIDE	
SMALL VESSEL SRVCE.	: SHOW	HIDE	

TURN KNOB, ▲▼ : SELECT PUSH KNOB : ENTER
 [0]~[9] : NO. OF PAGE ◀▶ : MOVE PAGE
 [MENU] : BACK





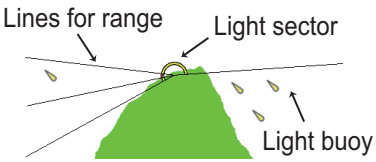

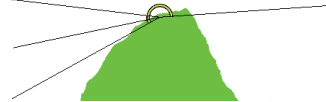
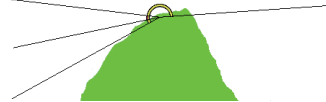









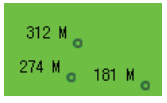

[COAST LINE DETAIL SETTING] menu: Page 2

[LANDMARKS], [OBSTACLES], [OBSTACLES IN A SAFE AREA], [FISHING EQUIPMENT], [SEABED COMPOSITION], [WATER QUALITY], [ALARM AREA], [LIGHT SECTOR]^{*1}, [MOUNTAINTOP], [LANDSCAPE], [FOG SIGNAL], [SIGNALS], [SERVICE], [HARBOR FACILITIES], [SMALL VESSEL SRVCE.], [CHART-RECOMMENDED ROUTES]^{*2}, [MARINE FARM]^{*2}[TIDAL STATION]^{*2}, [DEPTH]^{*2}, [DATA DISPLAY AREA]^{*2}, [OFFSHORE WIND TURBINE]^{*2}: Turns each mark on or off. See the table below. For [MARINE FARM], select [LINE] or [LINE+SYMBOL] to show its mark.

*1: The mark display for light sector differs according to the setting of light beacons/light buoys. For details, see the table below.

	[LIGHT SECTOR]: Set to [SHOW].	[LIGHT SECTOR]: Set to [HIDE].
[LIGHT BEACONS/LIGHT BUOYS]: Set to [SHOW].	Light sector and lines for range are displayed (lines for range are long). 	Only light sector is displayed (lines for range are short). 
[LIGHT BEACONS/LIGHT BUOYS]: Set to [HIDE].	Light sector and lines for range are displayed (lines for range are long). 	Light sector is not displayed. 

*2: [TIDAL STATION] is on page 3.

Mark name	Display example	Mark name	Display example
LIGHT BEACONS/ LIGHT BUOYS		BUOY	
CONTOUR LINES/ TIDAL CURRENT		LANDMARKS	
OBSTACLES		OBSTACLES IN A SAFE AREA	
FISHING EQUIP- MENT		SEABED COMPO- SITION	Mud
WATER QUALITY		ALARM AREA	
MOUNTAINTOP		LANDSCAPE	
FOG SIGNAL		SIGNALS	
SERVICE		HARBOR FACILI- TIES	
SMALL VESSEL SERVICE		CHART-RECOM- MENDED ROUTES	
MARINE FARM		TIDAL STATION	
OFFSHORE WIND TURBINE			

9. OTHER FUNCTIONS

Note: If text is displayed with a mark, the text can be difficult to see depending on the background.

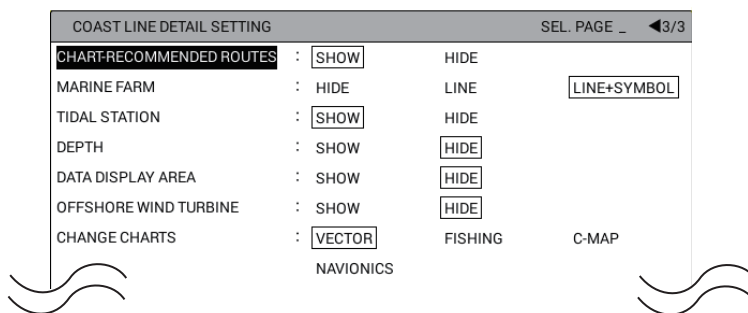

[COAST LINE DETAIL SETTING] menu: Page 3

When the [DATA DISPLAY AREA] menu is set to [SHOW], the following information appear.

- Information Areas, Protected Areas
- Anchorage Area, Anchor Berth
- Pipeline Area, Cable Area
- Dumping Ground
- Cargo Transhipment, Incineration
- Administrative Areas
- Continental Shelf
- Harbour Area, Free Port Area, Customs Zone
- Fishery Zone
- Contiguous Zone, Exclusive Economic Zone, National Territorial Area, Territorial Sea, Territorial Sea Baseline, Administration Area

[CHANGE CHARTS]: Selects chart type from among [VECTOR], [FISHING], [C-MAP], or [NAVIONICS].

[VECTOR]: MapMedia vector chart.

[FISHING]: MapMedia fishing chart.

[C-MAP]: MapMedia navigational chart based on C-MAP data.

[NAVIONICS]: MapMedia navigational chart based on Navionics data.

9.1.2 How to display depth contour in detail

You can set the level of detail between depth contour lines by the distance between the contour lines.

1. Press the **MENU** key to open the main menu.
2. Select [7. COAST LINE SETTING].

3. Select [2. CONTOUR LINE FINE RNG SETTINGS].

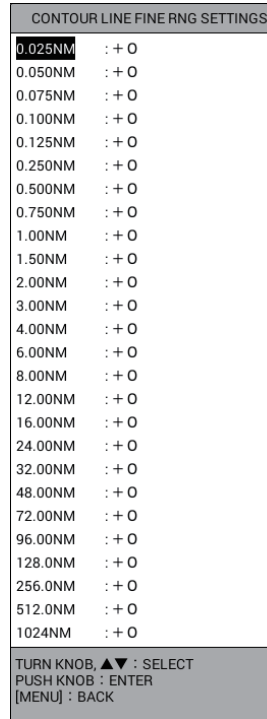

4. Select the range which you want to display in detail. The chart display appears in the selected range and the following window appears.

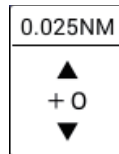

5. Set the level for detailed contour display watching the chart display. The larger the setting, the more detailed the contour lines are displayed. However, chart drawing speed is slowed.
- Note:** Contour lines may not be affected by the setting, depending on the range.
6. Press the **DISP** key to close the menu.

9.2 [PLOTTER DISPLAY SETTING] Menu

This section describes the [PLOTTER DISPLAY SETTING] menu. See section 2.1.4 for the [SATTELITE STATUS/LOCATION] menu, section 2.7 for the [SPECIAL CURSOR] menu.

9.2.1 How to set TD display

To display own ship position in TDs in the NAV information box, follow the procedure below.

How to display position in Loran A TD

1. Press the **MENU** key to open the main menu.
2. Select [8. PLOTTER DISPLAY SETTING].
3. Select [3. LORAN/DECCA SETTING].

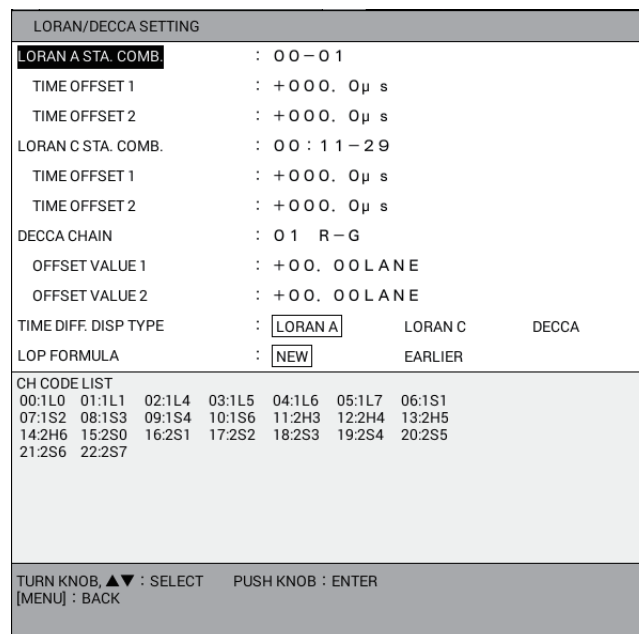

4. Select [LORAN A STA. COMB.].
5. Press the numeric keys to set the station combination referring to the [CH CODE LIST] at the bottom of the window. If necessary, follow the procedure from step 6 to enter offset. Otherwise, go to step 11.
6. Select [TIME OFFSET 1].
7. Press the numeric keys to enter offset. To switch between + and -, press the **CURSOR ON/OFF** key.
8. Enter offset for [TIME OFFSET 2] in the same way.
9. Select [TIME DIFF. DISP TYPE].
10. Select [LORAN A].
11. Press the **DISP** key to close the menu.

How to display position in Loran C TD

1. Press the **MENU** key to open the main menu.
2. Select [8. PLOTTER DISPLAY SETTING].
3. Select [3. LORAN/DECCA SETTING].

4. Select [LORAN C STA. COMB.].

LORAN/DECCA SETTING			
LORAN A STA. COMB.	:	00-01	
TIME OFFSET 1	:	+000. 0μ s	
TIME OFFSET 2	:	+000. 0μ s	
LORAN C STA. COMB.	:	00 : 11-29	
TIME OFFSET 1	:	+000. 0μ s	
TIME OFFSET 2	:	+000. 0μ s	
DECCA CHAIN	:	01 R-G	
OFFSET VALUE 1	:	+00. 00 LANE	
OFFSET VALUE 2	:	+00. 00 LANE	
TIME DIFF. DISP TYPE	:	LORAN A	LORAN C DECCA
LOP FORMULA	:	NEW	EARLIER
GRI CODE LIST			
00:4990	01:7960	02:7980	03:8970 04:9940 05:9960
06:9990	07:5930	08:5990	09:5970 10:9970 11:7930
12:7970	13:7990	14:9980	15:7170 16:8990 17:7950
18:8000	19:9610	20:8290	21:4991 22:8940 23:8930
24:7270	25:6731	26:7001	27:7499 28:9007 29:8830
30:7030			
TURN KNOB, ▲▼ : CHANGE VALUE PUSH KNOB : ENTER			
[0]~[9] : ENTER VALUE ◀▶ : MOVE CURSOR			
[CURSOR ON/OFF] : CHANGE MARK [MENU] : BACK			

5. Press the numeric keys to set the GRI code referring to the [GRI CODE LIST] at the bottom of the window. For example, press the **1, 0** keys in order for GRI9970. [RCH CODE LIST] for GRI9970 is displayed at the bottom of the window.

LORAN/DECCA SETTING			
LORAN A STA. COMB.	:	00-01	
TIME OFFSET 1	:	+000. 0μ s	
TIME OFFSET 2	:	+000. 0μ s	
LORAN C STA. COMB.	:	10 : 11-29	
TIME OFFSET 1	:	+000. 0μ s	
TIME OFFSET 2	:	+000. 0μ s	
DECCA CHAIN	:	01 R-G	
OFFSET VALUE 1	:	+00. 00 LANE	
OFFSET VALUE 2	:	+00. 00 LANE	
TIME DIFF. DISP TYPE	:	LORAN A	LORAN C DECCA
LOP FORMULA	:	NEW	EARLIER
GRI 9970 RCH CODE LIST			
11 30 55 81			
TURN KNOB, ▲▼ : CHANGE VALUE PUSH KNOB : ENTER			
[0]~[9] : ENTER VALUE ◀▶ : MOVE CURSOR			
[CURSOR ON/OFF] : CHANGE MARK [MENU] : BACK			

6. Press the numeric keys to set the chain station combination from [RCH CODE LIST] at the bottom of the window. If necessary, follow the procedure from step 7 to enter offset. Otherwise, go to step 12.
7. Select [TIME OFFSET 1].
8. Press the numeric keys to enter offset. To switch between + and -, press the **CURSOR ON/OFF** key.
9. Enter offset for [TIME OFFSET 2] in the same way.
10. Select [TIME DIFF. DISP TYPE].
11. Select [LORAN C].
12. Press the **DISP** key to close the menu.

How to display position in DECCA TDs

1. Press the **MENU** key to open the main menu.
2. Select [8. PLOTTER DISPLAY SETTING].
3. Select [3. LORAN/DECCA SETTING].
4. Select [DECCA CHAIN].
5. Press the numeric keys to enter chain number (01 to 48). [RCH LST] is displayed at the bottom of the window.

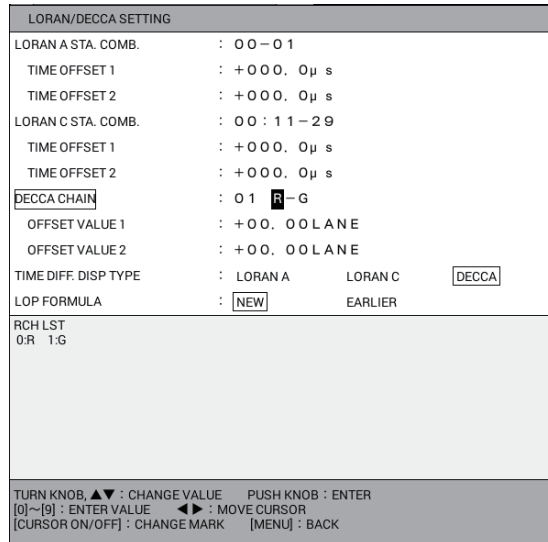

6. Press the numeric keys to set the chain station combination from [RCH LST] at the bottom of the window. If necessary, follow the procedure from step 7 to enter offset. Otherwise, go to step 12.
7. Select [OFFSET VALUE 1].
8. Press the numeric keys to enter offset. To switch between + and -, press the **CURSOR ON/OFF** key.
9. Enter offset for [OFFSET VALUE 2] in the same way.
10. Select [TIME DIFF. DISP TYPE].
11. Select [DECCA].
12. Press the **DISP** key to close the menu.

How to set calculation method for TDs

The value for TDs on the display differ depending on datum type though own ship position is same.

1. Press the **MENU** key to open the main menu.
2. Select [8. PLOTTER DISPLAY SETTING].
3. Select [3. LORAN/DECCA SETTING].
4. Select [LOP FORMULA].
5. Select [NEW] or [EARLIER].
 [NEW]: Displays position, calculated by WGS-84 datum, in TDs (or phase difference).
 [EARLIER]: Displays position, calculated by TOKYO datum, in TDs (or phase difference).
6. Press the **DISP** key to close the menu.

9.2.2 How to set range for plotter display

You can select the plotter display ranges you wish to use. After selecting the ranges desired, change the range with the **ZOOM IN** or **ZOOM OUT** key to activate range settings. Note that more than two range settings must be set to [ON].

1. Press the **MENU** key to open the main menu.
2. Select [8. PLOTTER DISPLAY SETTING].
3. Select [5. PLOTTER RANGE SETTING].

PLOTTER RANGE SETTING		SEL. PAGE	1/2▶
0.025NM	: <input type="checkbox"/> ON	OFF	
0.05NM	: <input type="checkbox"/> ON	OFF	
0.075NM	: <input type="checkbox"/> ON	OFF	
0.10NM	: <input type="checkbox"/> ON	OFF	
0.125NM	: <input type="checkbox"/> ON	OFF	
0.25NM	: <input type="checkbox"/> ON	OFF	
0.50NM	: <input type="checkbox"/> ON	OFF	
0.75NM	: <input type="checkbox"/> ON	OFF	
1.00NM	: <input type="checkbox"/> ON	OFF	
1.50NM	: <input type="checkbox"/> ON	OFF	
2.00NM	: <input type="checkbox"/> ON	OFF	
3.00NM	: <input type="checkbox"/> ON	OFF	
4.00NM	: <input type="checkbox"/> ON	OFF	
6.00NM	: <input type="checkbox"/> ON	OFF	
8.00NM	: <input type="checkbox"/> ON	OFF	
12.0NM	: <input type="checkbox"/> ON	OFF	
16.0NM	: <input type="checkbox"/> ON	OFF	

TURN KNOB ▲▼ : SELECT PUSH KNOB : ENTER
 [0]~[9] : NO. OF PAGE ◀▶ : MOVE PAGE
 [MENU] : BACK

Page 1

PLOTTER RANGE SETTING		SEL. PAGE	◀2/2
24.0NM	: <input type="checkbox"/> ON	OFF	
32.0NM	: <input type="checkbox"/> ON	OFF	
48.0NM	: <input type="checkbox"/> ON	OFF	
72.0NM	: <input type="checkbox"/> ON	OFF	
96.0NM	: <input type="checkbox"/> ON	OFF	
128NM	: <input type="checkbox"/> ON	OFF	
256NM	: <input type="checkbox"/> ON	OFF	
512NM	: <input type="checkbox"/> ON	OFF	
1024NM	: <input type="checkbox"/> ON	OFF	

TURN KNOB ▲▼ : SELECT PUSH KNOB : ENTER
 [0]~[9] : NO. OF PAGE ◀▶ : MOVE PAGE
 [MENU] : BACK

Page 2

4. Select the range to change.
5. Select [ON] or [OFF].
6. Press the **DISP** key to close the menu.

9.3 [DISPLAY FORMAT] Menu

The [DISPLAY FORMAT] menu contains items for setting up the display.

1. Press the **MENU** key to open the main menu.
2. Select [0. SYSTEM SETTING].
3. Select [1. DISPLAY FORMAT] which has six pages.
4. Select an item to change.
5. Select an option or set a value.
6. After setting all required items, press the **DISP** key to close the menu.

The description for each item is as shown below.

9. OTHER FUNCTIONS

DISPLAY FORMAT		SEL. PAGE	1/6▶
LANGUAGE	: English 中文 ภาษาไทย		
KEY BEEP	: BEEP ON BEEP OFF		
SPEED SENSOR	: INTERNAL GPS NMEA FOR SOG		
	NMEA FOR STW FISH FINDER		
NMEA SHIP SPD OFFSET	: + 0 0 % (-50 to +50)		
WATER TEMP. SENSOR	: NMEA FISH FINDER		
NMEA WTR TEMP OFFSET	: + 0 0 . 0 (-40.0 to +40.0)		
DEPTH SENSOR	: NMEA FISH FINDER		
NMEA DEPTH OFFSET	: + 0 0 0 . 0 f t (-15.0 to +100.0)		
DRIFT AVERAGE TIME	: 0 0 0 0 S.		
SELECT AUTOPILOT	: NMEA0183 NMEA2000 AUTOMATIC		
SEL. BEARING SENSOR	: NMEA0183 NMEA2000 AUTOMATIC		
HEADING OFFSET	: + 0 0 0 °		
SBAS SET BY SC	: USE DO NOT USE		
BEARING OFFSET	: + 0 0 0 °		
PITCH OFFSET	: + 0 0 °		
ROLL OFFSET	: + 0 0 °		
TURN KNOB, ▲▼ : SELECT PUSH KNOB : ENTER [0]~[9] : NO. OF PAGE ◀▶ : MOVE PAGE [MENU] : BACK			

[DISPLAY FORMAT] menu: Page 1

[LANGUAGE]: Selects language to use.

[KEY BEEP]: Enables or disables the beep that sounds each time a key is operated.

[SPEED SENSOR]: Selects the source of speed data from [INTERNAL GPS], [NMEA FOR SOG], [NMEA FOR STW] or [FISH FINDER]. For details, see the installation manual.

[NMEA SHIP SPD OFFSET]: An offset may be applied to NMEA speed data ([NMEA FOR SOG] or [NMEA FOR STW] at [SPEED SENSOR]). For details, see the installation manual.

[WATER TEMP. SENSOR]: Selects the source of water temperature data from [NMEA] or [FISH FINDER]. For details, see the installation manual.

[NMEA WTR TEMP OFFSET]: An offset may be applied to NMEA water temperature data. For details, see the installation manual.

[DEPTH SENSOR]: Selects the source of depth data from [NMEA] or [FISH FINDER]. For details, see the installation manual.

[NMEA DEPTH OFFSET]: An offset may be applied to NMEA depth data. For details, see the installation manual.

[DRIFT AVERAGE TIME]: Sets the time to average drift.

[SELECT AUTOPILOT]: Selects the source of autopilot data from [NMEA0183], [NMEA2000] or [AUTOMATIC]. For details, see the installation manual.

[SEL. BEARING SENSOR]: Selects the source of heading data from [NMEA0183], [NMEA2000] or [AUTOMATIC]. For details, see the installation manual.

[HEADING OFFSET]: Sets the offset value to correct the NMEA heading data. For details, see the installation manual.

[SBAS SET BY SC]: Use or do not use SBAS by Satellite Compass™, connected via NMEA2000. For details, see the installation manual.

[BEARING OFFSET]: Sets the offset value for heading.

[PITCH OFFSET]: Sets the offset value for pitch.

[ROLL OFFSET]: Sets the offset value for roll.

DISPLAY FORMAT		SEL. PAGE _ ◀2/6▶	
LAT./LON. GRID	: DD°MM.MM' DD°MM.MMM' DD°MM.MMMM'		
	: DD°MM'SS.S"		
RANGE/SPEED	: <input type="checkbox"/> NM, <input type="checkbox"/> kn	km, km/h	SM, mph
WIND SPEED	: <input type="checkbox"/> kn	m/s	mph
DEPTH	: m	<input type="checkbox"/> ft	fm
	HIRO		
HIRO SETTING	: 1 . 5 1 5 2		
WATER TEMPERATURE	: °C	<input type="checkbox"/> °F	
TIME	: 12 HOURS	<input type="checkbox"/> 24 HOURS	
BEARING MODE	: TRUE DIRECTION		<input type="checkbox"/> MAGNETIC DIR.
MAGNETIC BRG OFFSET	: <input type="checkbox"/> AUTOMATIC	MANUAL	
MANUAL MAG. VAR.	: 0 7 . 0 ° W		
DISP. HDG MARKER	: SHOW	<input type="checkbox"/> VECTOR	HIDE
DISP. COG MARKER	: <input type="checkbox"/> SHOW	VECTOR	HIDE
WPT. REFRESH SETTING	: <input type="checkbox"/> WPT ON VERTICAL LINE		
	ARRIVE ALARM WITHIN RANGE		
RNG & BRG MODE	: GREAT CIRCLE	<input type="checkbox"/> RHUMBLINE	
TURN KNOB, ▲▼ : SELECT PUSH KNOB : ENTER			
[0]~[9] : NO. OF PAGE ◀▶ : MOVE PAGE			
[MENU] : BACK			

[DISPLAY FORMAT] menu: Page 2

[LAT./LON. GRID]: Selects the display format for latitude and longitude from [DD°MM.MM'], [DD°MM.MMM'], [DD°MM.MMMM'], or [DD°MM'SS.S"].

[RANGE/SPEED]: Selects the unit for range and speed from [NM, kn], [km, km/h] or [SM, mph].

[WIND SPEED]: Selects the unit for wind speed from [kn], [m/s] or [mph].

[DEPTH]: Selects the unit for depth from [m], [ft], [fm] or [HIRO].

[HIRO SETTING]: Sets the value for 1 HIRO by meter.

[WATER TEMPERATURE]: Selects the unit for water temperature from [°C] or [°F].

[TIME]: Selects the format for time display from [12 HOURS] or [24 HOURS].

[BEARING MODE]: Selects how to calculate course and bearing, [TRUE DIRECTION] or [MAGNETIC DIR.]. True bearing is a bearing measured using true North as the reference direction, and it is calculated by the formula True Bearing = Magnetic Bearing + Magnetic Variation. Magnetic bearings are measured with magnetic north as the reference direction. Select [MAGNETIC DIR.] when using a magnetic compass, [TRUE DIRECTION] for using the gyrocompass.

[MAGNETIC BRG OFFSET]: Selects the method how to correct magnetic bearing, automatically or manually.

[MANUAL MAG. VAR.]: Sets the offset value for magnetic bearing when selecting [MANUAL] in [MAGNETIC BRG OFFSET]. The location of the magnetic north pole is different from the geographical north pole. This causes a difference between the true and magnetic north location. This difference is called magnetic variation, and varies with respect to the observation point on earth. Your unit is preprogrammed with all the earth's magnetic variations. However, you may wish to enter variation manually to refine accuracy.

9. OTHER FUNCTIONS

[DISP. HDG MARKER]: Turns the heading marker on or off. (Heading data is required.) [SHOW] shows white heading marker to the edge of the screen. [VECTOR] shows white vector of the length proportional to speed. The length does not change when switching the chart scale. The heading marker points heading.

[DISP. COG MARKER]: Turns course marker on or off. [SHOW] shows light-blue course marker to the edge of the screen. [VECTOR] shows light-blue vector of the length proportional to speed. The length does not change if switching the chart scale.

[WPT. REFRESH SETTING]: Selects waypoint switching method from [WPT ON VERTICAL LINE] or [ARRIVE ALARM WITHIN RANGE]. See "How to select the waypoint switching method" on page 7-7.

[RNG & BRG MODE]: When you set a destination, the equipment displays the range, bearing and course to that destination. Range and bearing are calculated by the Great Circle or Rhumbline method. Route total distance is also calculated. Cross-track distance is only calculated in the Rhumbline method.

[GREAT CIRCLE]: This course line is the shortest course between two points on the surface of the earth, like stretching a piece of string between two points on earth. Because frequent course changes are required it is most suitable for long-range navigation.

[RHUMBLINE]: This method calculates the range and bearing between two points drawn on a nautical chart. Since the bearing is kept constant it is ideal for short-range navigation.

DISPLAY FORMAT		SEL. PAGE _ ◀3/6▶	
SET GOTO METHOD	: ONE POINT	100 POINTS	
RANGE/SCALE	: RANGE	SCALE	HIDE
SCALE DISPLAY	: SHOW	HIDE	
GPS STATUS	: SHOW	HIDE	
WAYPOINT STATUS	: SHOW	HIDE	
WAYPOINT INFORMATION	: SHOW	HIDE	
DISPLAY MARK INFO.	: SHOW	HIDE	
SHOW OBJECT INFORMATION	: SHOW	HIDE	

TURN KNOB, ▲▼ : SELECT PUSH KNOB : ENTER
 [0]~[9] : NO. OF PAGE ◀▶ : MOVE PAGE
 [MENU] : BACK

[DISPLAY FORMAT] menu: Page 3

[SET GOTO METHOD]: Selects the method by which to navigate to a quick point from [ONE POINT] or [100 POINTS]. See section 7.1.

[RANGE/SCALE]: Selects the method how to show the display width, [RANGE], [SCALE] or [HIDE].

[SCALE DISPLAY]: Turns the scale on or off on the plotter display.

[GPS STATUS]: Turns GPS status abbreviations on or off on the plotter display.

[WAYPOINT STATUS]: Turns the waypoint status icon on or off on the plotter display.



This icon (default: ) shows the current shape and color of waypoints.

[WAYPOINT INFORMATION]: Turns the waypoint data on or off. When [SHOW] is selected, place the cursor on a waypoint to show the waypoint data box.

[DISPLAY MARK INFO.]: Turns the mark data (simple information) on or off. When [SHOW] is selected, place the cursor on a mark to show the mark data box.

[SHOW OBJECT INFORMATION]: Turns the chart object data (simple information*) on or off. When [SHOW] is selected, place the cursor on a chart object to show the object data box.

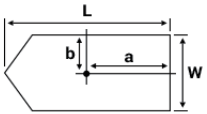
*: To show the detailed information for the chart object, place the cursor on the chart object then push the **ENTER** knob.

DISPLAY FORMAT		SEL. PAGE _ ◀4/6▶	
OWN SHIP'S MARK	: [LARGE]	SMALL	SHAPE OF SHIP
SHIP'S LENGTH	: 1 0. 0m	(0.1 to 99.9)	
SHIP'S WIDTH	: 0 2. 0m	(0.1 to 99.9)	
ANTENNA POSITION V a	: 0 5. 0m	(0.1 to 99.9)	
ANTENNA POS. SIDE b	: 0 1. 0m	(0.1 to 99.9)	
			
WAYPOINT OVERWRITE	: [CONFIRM]	CANCEL	
COG HOLD (LOW SPD)	: [YES (1kn)]	YES (0.2kn)	NO
WPT NAME DISPLAY	: HIDE UNNECESSARY "0"		
	: [DISPLAY ALL "0"]		
SHIP'S DIRECTION	: [COG]	HEADING	
CURSOR SHAPE	: [CROSSING LINE]	CROSS HAIR	
CURSOR COLOR	: 		
TURN KNOB, ▲▼ : SELECT PUSH KNOB : ENTER [0]~[9] : NO. OF PAGE ◀▶ : MOVE PAGE [MENU] : BACK			

[DISPLAY FORMAT] menu: Page 4

[OWN SHIP'S MARK]: Selects the size of own ship mark from [LARGE], [SMALL] or [SHAPE OF SHIP]. [SHAPE OF SHIP] is selected to indicate the length and width of your vessel, with [SHIP'S LENGTH], [SHIP'S WIDTH], [ANTENNA POSITION V a] and [ANTENNA POS. SIDE b] below.

[SHIP'S LENGTH]: Sets the ship's length. (See the installation manual.)

[SHIP'S WIDTH]: Sets the ship's width. (See the installation manual.)

[ANTENNA POSITION V a], [ANTENNA POS. SIDE b]: Sets the antenna unit position. (See the installation manual.)

[WAYPOINT OVERWRITE]: Turns the confirmation message on or off when entering an existing waypoint name.

[COG HOLD (LOW SPD)]: Selects whether to update COG or not when ship's speed is under 1 kn or under 0.2 kn.

[YES (1kn)]: COG is not updated when speed is under 1.0 kn.

[YES (0.2kn)]: COG is not updated when speed is under 0.2 kn.

[NO]: COG is updated regardless of ship's speed.

9. OTHER FUNCTIONS

[WPT NAME DISPLAY]: Shows or hides leading zero(es) in waypoint name, shown on the plotter display.

●
7
●
000007

[HIDE UNNECESSARY "0"] [DISPLAY ALL "0"]
 Waypoint name on the plotter display

[SHIP'S DIRECTION]: Selects orientation of own ship mark when setting own ship mark configuration to [SHAPE OF SHIP] in [OWN SHIP'S MARK].

[COG]: The bow points in the direction of actual advancement.

[HEADING]: The bow points in the direction of heading. Requires heading data. If there is no heading data, the orientation of bow varies with situation as shown below.

- When there is no heading data from the time of startup, the bow points 0°.
- When heading data is interrupt at work, the bow points the direction of the last received heading data.

[CURSOR SHAPE]: Selects the configuration of the cursor from [CROSSING LINE] or [CROSS HAIR]. (See section 2.2.)

[CURSOR COLOR]: Selects the color of the cursor from seven colors.

DISPLAY FORMAT		SEL. PAGE _ ◀5/6▶
DISPLAY OWN SHIP	: <input type="button" value="SHOW"/> HIDE	
OTHR SHIP INFO DISP.	: <input type="button" value="SHOW"/> HIDE	
VIDEO PILOT	: WITH <input type="button" value="NO"/>	
DRIFT/CURR. VCTR DISPLAY	: <input type="button" value="TO"/> FROM	
DISPLAY OS DRIFT VECTOR	: SHOW <input type="button" value="HIDE"/>	
OS CURR. VECTOR DISP	: SHOW <input type="button" value="HIDE"/>	
OTHER CURR VCT DISP	: SHOW <input type="button" value="HIDE"/>	
CURRENT DISPLAY 1	: 1 L.	
CURRENT DISPLAY 2	: 2 L.	
CURRENT DISPLAY 3	: 3 L.	
VECTOR DISPLAY LENGTH	: <input type="button" value="1 (SHORT)"/> 2 3	
	4 (LONG)	
TARGET SMART TRACK	: ON <input type="button" value="OFF"/>	
ENTER MOB	: <input type="button" value="OWN SHIP"/> CURSOR	
NAV. DATA TRANSPARENCY	: 5 0	
INFORMATION TRANSPARENCY	: 5 0	
TURN KNOB, ▲▼ : SELECT PUSH KNOB : ENTER [0]~[9] : NO. OF PAGE ◀▶ : MOVE PAGE [MENU] : BACK		

[DISPLAY FORMAT] menu: Page 5

DISPLAY FORMAT		SEL. PAGE _ ◀6/6▶
BKGD/LETTER COLOR	: WHITE ON BLUE BACKGROUND	
	<input type="button" value="BLACK ON WHITE BACKGROUND"/>	
	WHITE ON BLACK BACKGROUND	
	GREEN ON BLACK BACKGROUND	
EVENT SWITCH 1	: <input type="button" value="NONE"/> --- ENTER MOB	
	SCREEN SHOT INPUT MARK	
EVENT SWITCH 2	: <input type="button" value="NONE"/> --- ENTER MOB	
	SCREEN SHOT INPUT MARK	
POP UP MESSAGES	: <input type="button" value="DISPLAY"/> NO DISPLAY	

[DISPLAY FORMAT] menu: Page 6

[DISPLAY OWN SHIP]: Turns the own ship data on or off. When [SHOW] is selected, place the cursor on the own ship mark to show the own ship data box.

[OTHR SHIP INFO DISP.]: Turns other ship's data on or off. When [SHOW] is selected, place the cursor on other ship's mark (target symbol) to show other ship's data box.

[VIDEO PILOT]: Selects whether to return to the previously set course when the NAV mode is changed in the following manner:

NAV → any mode other than NAV → NAV

[WITH]: Restarts the course from the position where NAV mode is restored.

[NO]: Does not restart the course, regardless of NAV mode.

Note: This function is available with connection of a FURUNO autopilot. See the Operator's Manual of the autopilot for details.

[DRIFT/CURR. VCTR DISPLAY]: Indicates the drift/current direction. When [FROM] is selected, the drift/tidal current direction shown for own ship information and mark information are rotated 180°.

[DISPLAY OS DRIFT VECTOR]: Turns the drift vector on or off on the own ship mark (see "Simple calculation function for drift" on page 3-17).

[OS CURR. VECTOR DISP]: Turns the current vector on or off on the own ship mark. Requires current data received from NMEA0183.

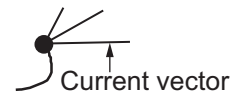

[OTHER CURR. VECTOR DISP]: No use.

[CURRENT DISPLAY 1], [CURRENT DISPLAY 2], [CURRENT DISPLAY 3]: Selects which layer to display for each current layer (1 L. to 5 L.).

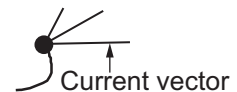

[VECTOR DISPLAY LENGTH]: Changes the length of vector line. [1 (SHORT)] displays the vector line with the shortest arrow marks. [4 (LONG)] displays the vector line with the longest arrow marks.

[TARGET SMART TRACK]: [ON] moves the selected ship symbol to the screen center. (See "How to display the GPS buoy list" on page 3-18, section 12.4.2.) When selecting [OFF], see section 2.2 and section 2.5 about the **CENTER** key.

To center the selected ship symbol on the plotter display, do the following:

1. If the cursor is displayed, press the **CURSOR ON/OFF** key to turn off the cursor.
2. Press the **CENTER** key.
3. Within two seconds of completing step 2, press the numeric key corresponding to the target number which you want to center. Up to 10 other ships can be centered. For example, press the **0** key for the target number 10.

Note 1: If the selected ship moves off the screen it is automatically moved to the screen center.

Note 2: Press the **CENTER** key twice to move the own ship to the screen center.

[ENTER MOB]: Selects the inscribing position of MOB mark, own ship or cursor position, when pressing the **MOB** key.

[NAV. DATA TRANSPARENCY]: Adjusts the degree of transparency for the NAV information box. Use a large figure to increase the degree of transparency.

Note: Alpha blending technology is used for transparency effects.

9. OTHER FUNCTIONS

[INFORMATION TRANSPARENCY]: Adjusts the degree of transparency for data windows of own ship, other ships and so on. Use a large figure to increase the degree of transparency.

Note: Alpha blending technology is used for transparency effects.

[BKGD/LETTER COLOR]: Selects the color combination for background of the menu screen, and characters in the menu screen and the NAV information box. [WHITE ON BLUE BACKGROUND], [BLACK ON WHITE BACKGROUND], [WHITE ON BLACK BACKGROUND] and [GREEN ON BLACK BACKGROUND] are available.

[EVENT SWITCH 1], [EVENT SWITCH 2]: Selects the function to run when pressing the event switch. [NONE], [ENTER MOB], [SCREEN SHOT] and [INPUT MARK] are available.

[POP UP MESSAGES]: No use.

9.4 [NAVIGATOR SETUP] Menu

The [NAVIGATOR SETUP] menu selects the source of navigation data and sets up the built-in GPS receiver.

1. Press the **MENU** key to open the main menu.
2. Select [0. SYSTEM SETTING].
3. Select [2. NAVIGATOR SETUP] which has two pages.
4. Select an item to change.
5. Select an option or set a value.
6. After desired items were set, press the **DISP** key to close the menu.

The description for each item is shown as below.

NAVIGATOR SETUP		SEL. PAGE _ 1/2▶	
SELECT NAV SOURCE	: INTERNAL	GPS	LORAN C
	ALL		
TIME DIFFERENCE	: +09:00		
NMEA TIME DIFFERENCE	: +00:00		
DATUM	: WGS-84	TOKYO	
POSITION SMOOTHING	: 000		
SPEED SMOOTHING	: 000		
SPEED AVERAGING	: 060		
NMEA SPEED AVERAGING	: 060		
LATITUDE OFFSET	: 0.000' N		
LONGITUDE OFFSET	: 0.000' E		
DISABLE SATELLITE(GPS)	: ___ ___		
ANTENNA HEIGHT	: 05m		
GPS FIX MODE	: 2D	2D/3D	
DIFFERENTIAL POSITIONING	: DGPS	SBAS	AUTOMATIC
	NO	QZSS	
TURN KNOB, ▲▼ : SELECT PUSH KNOB : ENTER [0]~[9] : NO. OF PAGE ◀▶ : MOVE PAGE [MENU] : BACK			

[NAVIGATOR SETUP] menu: Page 1

[SELECT NAV SOURCE]: Selects the source of position data from [INTERNAL], [GPS], [LORAN C] or [ALL]. For details, see the installation manual. When selecting [GPS], [LORAN C] or [ALL], "EXT" appears at the bottom left of the plotter display.

[TIME DIFFERENCE]: GPS uses UTC time. If you would rather use local time, enter the time difference between local time and UTC time. Use the **CURSOR ON/OFF** key to switch from "+" to "-" and vice versa. The setting range is -13:30 to +13:30.

[NMEA TIME DIFFERENCE]: If the NMEA time data fed from external equipment is wrong and cannot be corrected at the external equipment, enter an offset here to correct it. Use the **CURSOR ON/OFF** key to switch from "+" to "-" and vice versa.

[DATUM]: Your unit is preprogrammed with most of the major chart systems of the world. Although the WGS-84 system, the GPS standard, is now widely used other categories of charts still exist. Select the chart system used, not the area where your boat is sailing. "WGS-84" or "TOKYO" appears at the bottom left of the plotter display.

[POSITION SMOOTHING]: When the DOP or receiving condition is unfavorable, the GPS fix may change, even if the vessel is dead in water. This change can be reduced by smoothing the raw GPS fixes. A setting between 000 to 999 is available. The higher the setting, the more smoothed the raw data, however too high a setting slows response time to change in latitude and longitude. This is especially noticeable at high ship's speeds. 000 is the normal setting; increase the setting if the GPS fix changes.

[SPEED SMOOTHING]: During position fixing, ship's velocity (speed) is directly measured by receiving GPS satellite signals. The raw velocity data may change randomly depending on receiving conditions and other factors. You can reduce this random variation by increasing the smoothing. Like with latitude and longitude smoothing, the higher the speed smoothing the more smoothed the raw data. If the setting is too high, however, the response to speed and course change slows. For no smoothing, enter all zeroes.

[SPEED AVERAGING]: Calculation of ETA and TTG is based on average ship's speed over a given period. If the period is too long or too short, calculation error will result. Change the setting accordingly if calculation error occurs.

[NMEA SPEED AVERAGING]: Speed averaging for the ship's speed data received from external equipment in NMEA format.

[LATITUDE OFFSET], [LONGITUDE OFFSET]: GPS-generated position may be off by some seconds because of various factors. In this case, you can apply an offset to GPS position to refine position accuracy. Calculate the error on a nautical chart. The L/L offset icon () appears at the bottom right of the plotter display.

[DISABLE SATELLITE(GPS)]: Every GPS satellite is broadcasting abnormal satellite number(s) in its Almanac, which contains general orbital data about all GPS satellites, including those which are malfunctioning. Using this information, the GPS receiver automatically eliminates any malfunctioning satellite from the GPS satellite schedule. However, the Almanac sometimes may not contain this information. If you hear about a malfunctioning satellite from another source, you can disable it manually. Enter satellite number (max. 3 satellites) in two digits.

[ANTENNA HEIGHT]: Enter the height of the antenna unit above sea surface.

[GPS FIX MODE]: Selects the position-fixing mode from 2D or 2D/3D. When selecting 2D/3D, 2D or 3D is automatically selected depending on the number of available satellites. (3D requires four or more satellites.)

[DIFFERENTIAL POSITIONING]: Selects the position-fixing method from [DGPS], [SBAS], [AUTOMATIC], [NO], [QZSS]. (For SBAS/QZSS service area, see "WHAT IS

9. OTHER FUNCTIONS

SBAS/QZSS(SLAC)/DC REPORT?" on page AP-14.) The GP-3700F requires the optional DGPS beacon receiver to fix position by DGPS. [AUTOMATIC] fixes position by SBAS when DGPS correction data is not available. [QZSS] is the Japanese government developed positioning system. For normal GPS positioning, select [NO].

NAVIGATOR SETUP		SEL. PAGE _ ◀2/2
DIFFERENTIAL POSITIONING ALARM	: ON	[OFF]
DGPS BEACON STATION	: [AUTOMATIC]	MANUAL
FREQUENCY SETTINGS	: 2 9 5 . 0 k H z	
DGPS BAUD RATE	: 50	100 [200]
SBAS SATELLITE SEL.	: [AUTOMATIC]	MANUAL
SBAS MAN. SAT. SET.	: 1 3 4	
DISABLE SATELLITE(SBAS)	: _ _ _ _	_ _ _ _
DISABLE SATELLITE(QZSS)	: _ _ _ _	_ _ _ _
COURSE UP REDRAW ANGLE	: 2 2 . 5 °	(20.0 to 60.0)
FREE UP ANGLE	: 0 0 0 °	
COURSE SMOOTHING	: 0 0 0	
ROLLOVER	: 2 0 3 4	
RTE SENTENCE	: [LEGACY]	DNV

TURN KNOB, ▲▼ : SELECT PUSH KNOB : ENTER
 [0]~[9] : NO. OF PAGE ◀▶ : MOVE PAGE
 [MENU] : BACK

[NAVIGATOR SETUP] menu: Page 2

[DIFFERENTIAL POSITIONING ALARM]: This alarm alerts you when the DGPS or SBAS signal is lost.

[ON]: Alarm sounds when the position fixing method is switched from DGPS (or SBAS) to GPS. Alarm sounds until the position fixing method is restored to DGPS (or SBAS), or silencing the buzzer.

[OFF]: Alarm does not sound when the DGPS or SBAS signal is lost.

[DGPS BEACON STATION]: DGPS reference station can be searched automatically or manually. For manual search, select [MANUAL] here, and set the frequency of the DGPS reference station in the item [FREQUENCY SETTINGS].

[FREQUENCY SETTINGS]: When selecting [MANUAL] in [DGPS BEACON STATION], set the frequency of the DGPS reference station which is the nearest to own ship.

[DGPS BAUD RATE]: When selecting [MANUAL] in [DGPS BEACON STATION], select the transmission rate of the DGPS reference station nearest you, from [50], [100] or [200] (bps).

[SBAS SATELLITE SEL.]: Available GEO satellites are shown below.

Provider	Satellite type	Longitude	Satellite No.
WAAS	Intelsat Galaxy XV	133°W	135
	TeleSat Anik F1R	107.3°W	138
	Inmarsat-4-F3	98°W	133
EGNOS	Inmarsat-3-F2/AOR-E	15.5°W	120
	Inmarsat-4-F2	25°E	126
	SES-5	5°E	136
MSAS	MTSAT-1R	140°E	129
	MTSAT-2	145°E	137

Provider	Satellite type	Longitude	Satellite No.
GAGAN	GSAT-8	55°E	127
	GSAT-10	83°E	128

[AUTOMATIC]: Automatically search for the GEO satellite within your current position.

[MANUAL]: Enter appropriate GEO satellite number (120 to 138) manually in [SBAS MAN. SAT. SET.].

Note: Select [AUTOMATIC]. The SBAS position fix requires time for [MANUAL].

[SBAS MAN. SAT. SET.]: When selecting [MANUAL] in [SBAS SATELLITE SEL.], manually enter the GEO satellite number (120 to 138).

[DISABLE SATELLITE(SBAS)], [DISABLE SATELLITE(QZSS)]: Every GPS satellite is broadcasting abnormal satellite number(s) in its Almanac, which contains general orbital data about all GPS satellites. Using this information, the GPS receiver automatically eliminates any malfunctioning satellite from the GPS satellite schedule. However, the Almanac sometimes may not contain this information. You can disable an inoperative satellite manually. Enter satellite numbers (up to three satellites each for SBAS or QZSS) in three digits.

[COURSE UP REDRAW ANGLE]: Sets the angle to redraw the course in the AC up mode (20 to 60°). See section 2.4.

[FREE UP ANGLE]: Sets the angle which points to the top of the screen in the Specified direction up mode. See section 2.4.

[COURSE SMOOTHING]: During position fixing, ship's course is directly measured by receiving GPS satellite signals. The raw course data may change randomly depending on receiving conditions and other factors. You can reduce this random variation by increasing the smoothing. Like with latitude and longitude smoothing, the higher the course smoothing the more smoothed the raw data. If the setting is too high, however, the response to speed and course change slows. For no smoothing, enter all zeroes.

[ROLLOVER]: Sets the year to current one when the GPS is rolled over.

[RTE SENTENCE]: Selects RTE sentence mode from [LEGACY] or [DNV].

9.5 [INPUT/OUTPUT PORT SETTING] Menu

This menu sets up the I/O ports, and is normally done at the installation. Be sure the ports are correctly set. Improper setting may prevent transfer of data between this unit and external equipment.

9.5.1 How to set the output 1, 2 or 3

1. Press the **MENU** key to open the main menu.
2. Select [0. SYSTEM SETTING].

9. OTHER FUNCTIONS

3. Select [5. INPUT/OUTPUT PORT SETTING].

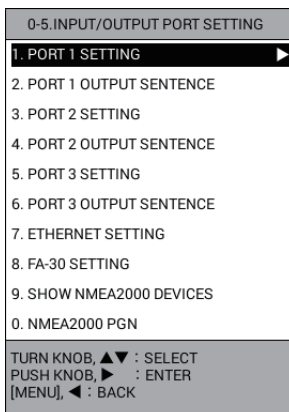

4. Select [1. PORT 1 SETTING], [3. PORT 2 SETTING] or [5. PORT 3 SETTING].

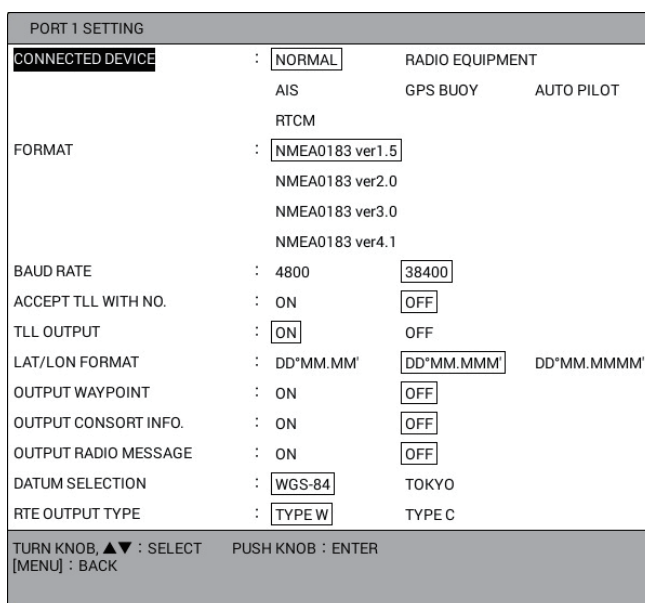

5. Select an item to change.

[CONNECTED DEVICE]: Selects the device connected to the port 1 (or 2, 3) from [NORMAL], [RADIO EQUIPMENT], [AIS], [GPS BUOY], [AUTO PILOT] or [RTCM].

[FORMAT]: Selects [NMEA0183 ver1.5], [NMEA0183 ver2.0], [NMEA0183 ver3.0] or [NMEA0183 ver4.1] depending on the navigator connected.

[BAUD RATE]: Selects the baud rate (bps) from [4800] or [38400].

[ACCEPT TLL WITH NO.]: Select [ON] to register the TLL mark or the waypoint when receiving the TLL data with the target number from the connected radar.

[TLL OUTPUT]: Select [ON] to output L/L data, at the moment a mark is entered, to the navigator connected.

[LAT/LON FORMAT]: Selects the number of minute places to shown in latitude and longitude position, from hundredth, thousandth or ten thousandth.

[OUTPUT WAYPOINT]: Select [ON] to output the WPL and RTE sentences to the navigator connected when setting a route as destination.

Note: The RTE sentence is not output for the route which has only one waypoint (quick point).

[OUTPUT CONSORT INFO.]: Select [ON] to output the consort data to the navigator connected.

[OUTPUT RADIO MESSAGE]: Select [ON] to output the radio message to the navigator connected.

[DATUM SELECTION]: Selects the datum for the external equipment connected from [WGS-84] or [TOKYO].

[RTE OUTPUT TYPE]: Selects the output type for the RTE sentence from [TYPE W] or [TYPE C].

6. Select an option.
7. Press the **MENU** key to return to the [5. INPUT/OUTPUT PORT SETTING] menu.
8. Select [2. PORT 1 OUTPUT SENTENCE], [4. PORT 2 OUTPUT SENTENCE] or [6. PORT 3 OUTPUT SENTENCE].

PORT 1 OUTPUT SENTENCE		SEL. PAGE _ 1/2▶
OUTPUT AAM	: OUTPUT	<input type="button" value="NO OUTPUT"/>
OUTPUT APB	: <input type="button" value="OUTPUT"/>	NO OUTPUT
OUTPUT BOD	: OUTPUT	<input type="button" value="NO OUTPUT"/>
BWR/BWC OUTPUT	: OUTPUT	<input type="button" value="NO OUTPUT"/>
OUTPUT DBT/DPT	: OUTPUT	<input type="button" value="NO OUTPUT"/>
OUTPUT DTM	: OUTPUT	<input type="button" value="NO OUTPUT"/>
OUTPUT GGA	: OUTPUT	<input type="button" value="NO OUTPUT"/>
OUTPUT GLL	: <input type="button" value="OUTPUT"/>	NO OUTPUT
OUTPUT GTD	: OUTPUT	<input type="button" value="NO OUTPUT"/>
OUTPUT MTW	: OUTPUT	<input type="button" value="NO OUTPUT"/>
OUTPUT RMA	: OUTPUT	<input type="button" value="NO OUTPUT"/>
OUTPUT RMB	: <input type="button" value="OUTPUT"/>	NO OUTPUT
OUTPUT RMC	: <input type="button" value="OUTPUT"/>	NO OUTPUT
OUTPUT VHW	: OUTPUT	<input type="button" value="NO OUTPUT"/>
OUTPUT VTG	: <input type="button" value="OUTPUT"/>	NO OUTPUT
OUTPUT WPL	: OUTPUT	<input type="button" value="NO OUTPUT"/>

TURN KNOB, ▲▼ : SELECT PUSH KNOB : ENTER
[0]~[9] : NO. OF PAGE ◀▶ : MOVE PAGE
[MENU] : BACK

Page 1

PORT 1 OUTPUT SENTENCE		SEL. PAGE _ ◀2/2
OUTPUT XTE	: OUTPUT	<input type="button" value="NO OUTPUT"/>
OUTPUT ZDA	: <input type="button" value="OUTPUT"/>	NO OUTPUT
OUTPUT HDT	: OUTPUT	<input type="button" value="NO OUTPUT"/>
OUTPUT HDG	: OUTPUT	<input type="button" value="NO OUTPUT"/>
OUTPUT MWV	: OUTPUT	<input type="button" value="NO OUTPUT"/>
OUTPUT TTM	: OUTPUT	<input type="button" value="NO OUTPUT"/>
OUTPUT GNS	: OUTPUT	<input type="button" value="NO OUTPUT"/>
OUTPUT GSA	: OUTPUT	<input type="button" value="NO OUTPUT"/>
OUTPUT GSV	: OUTPUT	<input type="button" value="NO OUTPUT"/>
OUTPUT THS	: OUTPUT	<input type="button" value="NO OUTPUT"/>

TURN KNOB, ▲▼ : SELECT PUSH KNOB : ENTER
[0]~[9] : NO. OF PAGE ◀▶ : MOVE PAGE
[MENU] : BACK

Page 2

9. Select the sentence to change.
10. Select [OUTPUT] or [NO OUTPUT].

Note: When using the function of marks transmission (see section 4.10), there are restrictions on the use of the function for the TTM sentence output. You can select [OUTPUT] in [OUTPUT TTM] to only one port. Also, you cannot enter TT data. When selecting [NO OUTPUT] in [OUTPUT TTM], there are no restrictions on the input of TT data.
11. Press the **DISP** key to close the menu.

9.5.2 How to set the Ethernet

1. Press the **MENU** key to open the main menu.
2. Select [0. SYSTEM SETTING].
3. Select [5. INPUT/OUTPUT PORT SETTING].
4. Select [7. ETHERNET SETTING].

ETHERNET SETTING	
IP ADDRESS	: 1 7 2 . 0 3 1 . 0 1 4 . 0 0 6
SUBNET MASK	: 2 5 5 . 2 5 5 . 0 0 0 . 0 0 0
DEFAULT GATEWAY	: 0 0 0 . 0 0 0 . 0 0 0 . 0 0 0
FA-30 IP ADDRESS	: 1 7 2 . 0 3 1 . 0 2 4 . 0 0 2
MARK SEND SETTINGS(RADAR)	: YES <input type="button" value="NO"/>

TURN KNOB, ▲▼ : SELECT PUSH KNOB : ENTER
[MENU] : BACK

5. Select [IP ADDRESS]*.
6. Use the numeric keys to enter the IP address.
7. Select [SUBNET MASK]*.

9. OTHER FUNCTIONS

8. Use the numeric keys to enter the subnet mask.
9. Select [DEFAULT GATEWAY]*.
10. Use the numeric keys to enter the default gateway.
11. Select [FA-30 IP ADDRESS].
12. Use the numeric keys to enter the IP address for the FA-30 connected.
13. Press the **DISP** key to close the menu.

*: When changing the setting for [IP ADDRESS], [SUBNET MASK], or [DEFAULT GATEWAY], the following message appears.



Push the **ENTER** knob, and then reboot the GP-3700F.

9.5.3 How to set the FA-30

When a FURUNO FA-30 is connected to this equipment, you can set up the FA-30 from this equipment.

1. Press the **MENU** key to open the main menu.
2. Select [0. SYSTEM SETTING].
3. Select [5. INPUT/OUTPUT PORT SETTING].
4. Select [8. FA-30 SETTING].

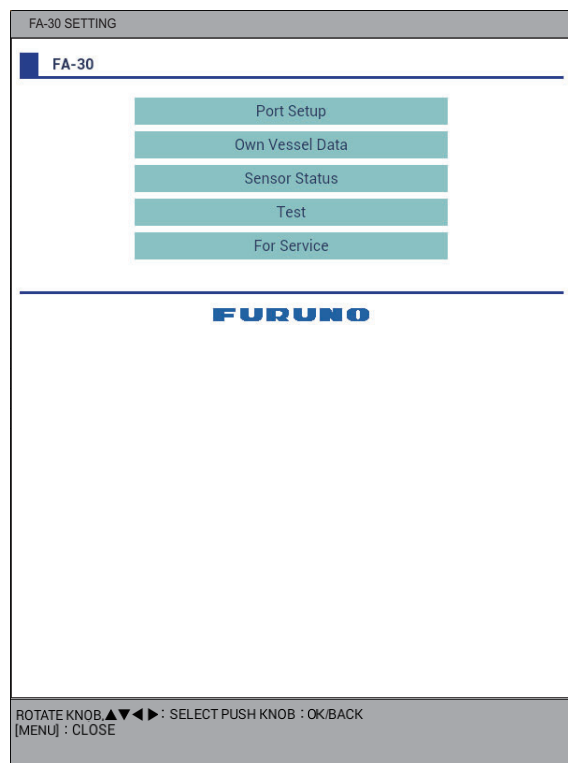

5. Set each item referring to the operator's manual of the FA-30.
6. Press the **DISP** key to close the menu.

9. OTHER FUNCTIONS

4. Select [0. NMEA2000 PGN].

NMEA2000 PGN		SEL. PAGE	1/2▶
126992 OUTPUT SYSTEM TIME	: OUTPUT	NO OUTPUT	
127258 OUTPUT MAGNETIC VARIATION	: OUTPUT	NO OUTPUT	
128267 OUTPUT WATER DEPTH	: OUTPUT	NO OUTPUT	
128275 OUTPUT DISTANCE LOG	: OUTPUT	NO OUTPUT	
129025 OUTPUT POSN, RAPID UPDATE	: OUTPUT	NO OUTPUT	
129026 OUTPUT COG&SOG RAPID UPDATE	: OUTPUT	NO OUTPUT	
129029 OUTPUT GNSS POSITION DATA	: OUTPUT	NO OUTPUT	
129283 OUTPUT CROSS TRACK ERROR	: OUTPUT	NO OUTPUT	
129284 OUTPUT NAVIGATION DATA	: OUTPUT	NO OUTPUT	
129285 OUTPUT NAV - ROUTE/ WP INFO	: OUTPUT	NO OUTPUT	

TURN KNOB, ▲▼ : SELECT PUSH KNOB : ENTER
[0]~[9] : NO. OF PAGE ◀▶ : MOVE PAGE
[MENU] : BACK

Page 1

NMEA2000 PGN		SEL. PAGE	◀2/2
129538 OUTPUT GNSS CONTROL STATUS	: OUTPUT	NO OUTPUT	
129539 OUTPUT GNSS DOPS	: OUTPUT	NO OUTPUT	

TURN KNOB, ▲▼ : SELECT PUSH KNOB : ENTER
[0]~[9] : NO. OF PAGE ◀▶ : MOVE PAGE
[MENU] : BACK

Page 2

5. Select a PGN to change.
6. Select [OUTPUT] or [NO OUTPUT].
7. Press the **DISP** key to close the menu.

9.6 [TEST & MEMORY CLEAR] Menu

This menu provides the diagnostic test, memory clearing, password setting, and trackball sensitivity. In this section, the password and trackball functions are described. For the diagnostic test, see section 13.8, the memory and user data clearing, see section 13.9.

9.6.1 How to set or change the password

You may use a password to prevent unauthorized operation of the equipment. The equipment cannot be operated unless the correct password is entered, at the powering of the equipment. Do not forget the password. If you forget the password, contact your dealer for advice. (The qualified technician can reset the password; however, all waypoints and marks will be erased.)

1. Press the **MENU** key to open the main menu.
2. Select [0. SYSTEM SETTING].
3. Select [6. TEST & MEMORY CLEAR].

0-6. TEST & MEMORY CLEAR	
1. MEMORY INPUT/OUTPUT TEST	▶
2. KEYBOARD TEST	
3. TEST PATTERN	
4. MEMORY CLEAR	
5. SCREENSHOT CLEAR	
6. SET PASSWORD	
7. DISABLE PASSWORD	
8. TRACKBALL	
9. CLEAR USER DATA	

TURN KNOB, ▲▼ : SELECT
PUSH KNOB, ▶ : ENTER
[MENU], ◀ : BACK

4. Select [6. SET PASSWORD].

SET PASSWORD
PASSWORD : ■
SET A USER PASSWORD. ENTER FOUR DIGITS WITH NUMERAL KEYS

5. Use the numeric keys to enter the password with four digits.

CONFIRM PASSWORD SETTING
PASSWORD : ■
CONFIRM PASSWORD. ENTER FOUR DIGITS WITH NUMERAL KEYS

6. Enter the password set at step 5 again. The message "PASSWORD IS DECIDED. THE PASSWORD WILL BE EFFECTIVE FROM NEXT TIME." appears.
7. Push the **ENTER** knob.
8. Press the **DISP** key to close the menu.

9.6.2 How to disable the password

To disable the password, do the following:

1. Press the **MENU** key to open the main menu.
2. Select [0. SYSTEM SETTING].
3. Select [6. TEST & MEMORY CLEAR].
4. Select [7. DISABLE PASSWORD].

	DEACTIVATE PASSWORD. ARE YOU SURE?
RUN	CANCEL

5. Select [RUN].
6. Press the **DISP** key to close the menu.

9.6.3 How to set the trackball sensitivity

You can set the sensitivity for the cursor movement when rotating the trackball.

1. Press the **MENU** key to open the main menu.
2. Select [0. SYSTEM SETTING].
3. Select [6. TEST & MEMORY CLEAR].
4. Select [8. TRACKBALL].

TRACKBALL			
TRKBALL SENSITIVITY	:	HIGH	MEDIUM LOW
VIBRATION FILTER	:	0 0 0	
TERM. TIME	:	0 1 0 S.	
TURN KNOB, ▲▼ : SELECT PUSH KNOB : ENTER [MENU] : BACK			

5. Select [TRACKBALL SENSITIVITY].

9. OTHER FUNCTIONS

6. Select [HIGH], [MEDIUM] or [LOW].
[HIGH]: The cursor responds quickly when rotating the trackball.
[MEDIUM]: The cursor responds at the intermediate speed between [HIGH] and [LOW].
[LOW]: The cursor moves slowly when rotating the trackball.
When the cursor moves because of the heavy hull vibration without rotating the trackball, select [MEDIUM]. If the cursor still moves, select [LOW].
7. Select [VIBRATION FILTER].
8. Use the numeric keys to set the vibration filter (setting range: 0 to 100). If the cursor moves without human intervention, because of hull vibration, increase this setting to lessen trackball sensitivity to vibration.
Note: A large setting can affect cursor response, because minute operation of the trackball may be seen as vibration.
9. Select [TERM. TIME].
10. Use the numeric keys to set the release time. The vibration filter is deactivated within the setting time after the last cursor operation by the trackball.
11. Press the **DISP** key to close the menu.

9.7 LINE MONITOR

The data input/output from/to the serial ports can be monitored, and the data can be saved to a USB flash memory.

Note: The line monitor log can not be saved to the USB flash memory when the data logger function (see section 10.6) is active. To save the log, select [NONE] in [OP. MODE SETTINGS] under [SYSTEM SETTING] - [MAINTENANCE] menu.

1. Press the **MENU** key to open the main menu.
2. Select [0. SYSTEM SETTING].
3. Select [LINE MONITOR].

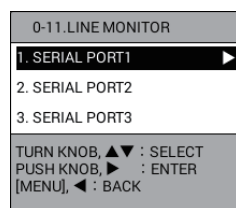

- Select a serial port to display RX/TX sentences. To stop showing the sentences, press the **0** key. The indication "PLAYING" at the top of the screen changes to "TEMP STOP DISP". To re-display the sentences, press the **0** key.

SERIAL PORT1		
38400bps	PLAYING	NO USB
RX		
TX		
<pre> \$GPVTG, T, 107.5, M, 10.000, N, 18.520, K \$GPZDA, 001125.01, 01, 2015, -09 \$GPRMC, 001125, V, 3442.056, N, 13508.617, E, 10.0, 100.0, 010115.7, 5, W#4F \$SPGLL, 3442.056, N, 13508.617, E \$GPAPB, V, 0.702, L, N, V, V, 121.3, M, 1001.114, 5, M, .M \$GPRMB, V, 0.70, L, 0000, 1001, 3440, 309, N, 13515.561, E, 5.984, 107.0, 9.9, V#28 \$GPVTG, T, 107.5, M, 10.000, N, 18.520, K \$GPZDA, 001126.01, 01, 2015, -09 \$GPRMC, 001126, V, 3442.055, N, 13508.619, E, 10.0, 100.0, 010115.7, 5, W#41 \$SPGLL, 3442.055, N, 13508.619, E \$GPVTG, T, 107.5, M, 10.000, N, 18.520, K \$GPZDA, 001127.01, 01, 2015, -09 \$GPRMC, 001127, V, 3442.055, N, 13508.621, E, 10.0, 100.0, 010115.7, 5, W#4B \$SPGLL, 3442.055, N, 13508.621, E \$GPRMB, V, 0.70, L, 0000, 1001, 3440, 309, N, 13515.561, E, 5.980, 107.0, 9.9, V#2C \$GPVTG, T, 107.5, M, 10.000, N, 18.520, K \$GPZDA, 001128.01, 01, 2015, -09 \$GPRMC, 001128, V, 3442.054, N, 13508.623, E, 10.0, 100.0, 010115.7, 5, W#47 \$SPGLL, 3442.054, N, 13508.623, E \$GPVTG, T, 107.5, M, 10.000, N, 18.520, K </pre>		
PUSH KNOB : RECORD START/STOP [0]: PAUSE/RESUME [MENU] : BACK		

Example: [1. SERIAL PORT1]

To save the log data to a USB flash memory, go to step 5. Otherwise, go to step 9.

- Connect a USB flash memory to the USB port (see section 10.3.1). The indication "NO USB" at the top of the screen changes to "STOPPED SAVING".
- Push the **ENTER** knob to save the log data. The indication "STOPPED SAVING" at the top of the screen changes to "SAVING".
- To complete the saving, push the **ENTER** knob. The indication "SAVING" at the top of the screen changes to "STOPPED SAVING".
- Remove the USB flash memory (see section 10.3.2).
- Press the **DISP** key to close the menu.

Note: The storage location (GP-3700/MonitorLog) and file name format (GP-3700_AA_CCCC_YYYYMMDDHHMMSS.log) are the same for both the line monitor and data logger functions.

- AA: Shows [Tx] for data transmitted by GP-3700/F and [Rx] for data received.
- CCCC: Shows serial port number [Port1], [port2], or [Port3].
- YYYYMMDDHHMMSS: Shows the file creation time (year-month-day-hour-minute-second; local time).

9. OTHER FUNCTIONS

This page is intentionally left blank.

10. HOW TO RECORD, PLAY BACK DATA

This chapter provides information necessary for recording and playing back data, and uploading and downloading data to (from) a USB flash memory.

10.1 Data Recording

Data can be recorded in the “working memory”. The working memory stores data such as tracks, marks, lines, routes, waypoints, setting data. When it is full, earliest data are erased one by one to make room for new data. Thus it is good idea to save important data to a USB flash memory or the internal memory.

This unit’s memory configuration is as shown below.

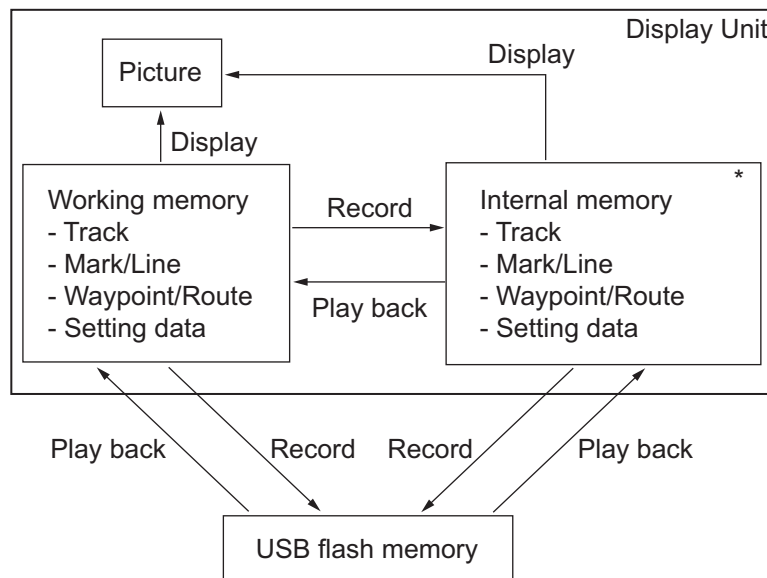

*: There are 10 internal memory blocks. Up to 30,000 track points for own ship, 40,000 track points for other ship, 30,000 marks/lines, 3,500 waypoints, 200 routes with 100 route points each and setting data can be stored in each block.

10.2 Internal Memory

This equipment has 10 internal memories in which to store data. Data are saved and replayed between the working memory and internal memory.

10.2.1 How to save the data to the internal memory

Data in the working memory can be saved to the internal memories. Up to 30,000 track points for own ship, 40,000 track points for other ship, 30,000 marks/lines, 3,500 waypoints, 200 routes with 100 route points each and setting data can be stored in each internal memory block.

1. Press the **MENU** key to open the main menu.

10. HOW TO RECORD, PLAY BACK DATA

2. Select [3. USB/INTERNAL MEMORY MANAGEMENT].

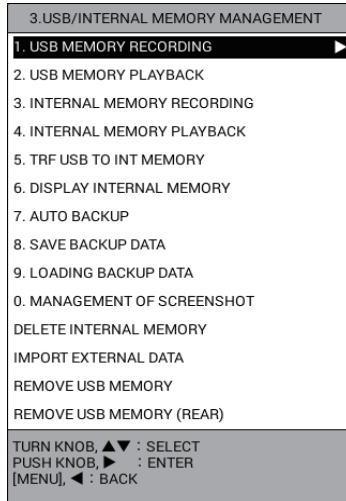

3. Select [3. INTERNAL MEMORY RECORDING].

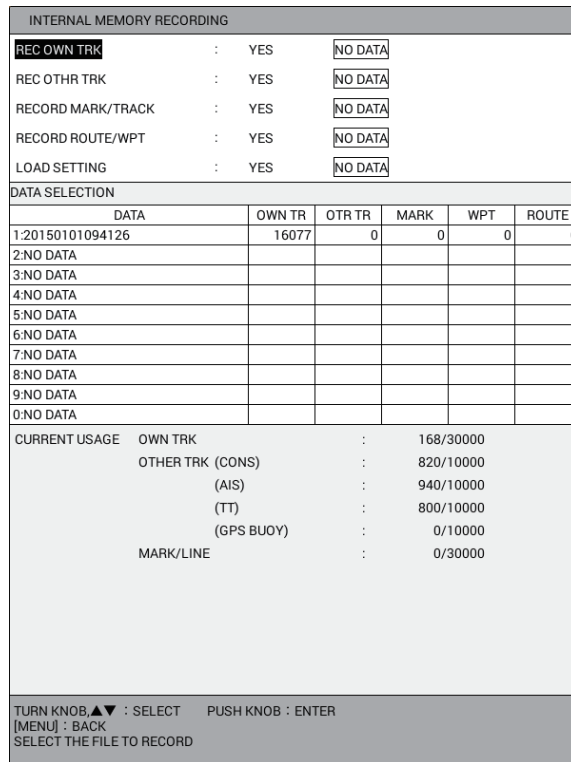

4. Select an item to save.
5. Select [YES].
6. Repeat steps 4 and 5 to save other items.
7. Select one of 10 memory blocks from [DATA SELECTION] to show the [COMMENT] window. The current date is automatically named as the comment. To change the comment, go to the next step. Otherwise, go to step 9.
8. Enter the comment (up to 15 characters) (see "How to enter alphanumeric data" on page 1-10) then select [ENTER]. The message "RECORD CURRENT DATA TO INTERNAL MEMORY. ARE YOU SURE?" appears.
9. Select [RUN] to save the data.
10. When the message of recording end appears, push the **ENTER** knob.
11. Press the **DISP** key to close the menu.

10.2.2 How to display the data stored in the internal memory

Tracks, marks and lines stored in the internal memory can be displayed on the screen.

1. Press the **MENU** key to open the main menu.
2. Select [3. USB/INTERNAL MEMORY MANAGEMENT].
3. Select [6. DISPLAY INTERNAL MEMORY] which has three pages ([INT MEMORY 1] to [INT MEMORY 10]).

DISPLAY INTERNAL MEMORY		SEL. PAGE	1/3▶
INT MEMORY 1			
DISPLAY OWN TRACK	: YES	<input type="checkbox"/> NO	2150/30000
DISP OTHER TRCK (CONS)	: YES	<input type="checkbox"/> NO	500/40000
ADD MARK / LINE DISP.	: YES	<input type="checkbox"/> NO	1800/30000
INT MEMORY 2			
DISPLAY OWN TRACK	: YES	<input type="checkbox"/> NO	2000/30000
DISP OTHER TRCK (CONS)	: YES	<input type="checkbox"/> NO	480/40000
ADD MARK / LINE DISP.	: YES	<input type="checkbox"/> NO	1750/30000
INT MEMORY 3			
DISPLAY OWN TRACK	: YES	<input type="checkbox"/> NO	2300/30000
DISP OTHER TRCK (CONS)	: YES	<input type="checkbox"/> NO	650/40000
ADD MARK / LINE DISP.	: YES	<input type="checkbox"/> NO	2100/30000
INT MEMORY 4			
DISPLAY OWN TRACK	: YES	<input type="checkbox"/> NO	2700/30000
DISP OTHER TRCK (CONS)	: YES	<input type="checkbox"/> NO	850/40000
ADD MARK / LINE DISP.	: YES	<input type="checkbox"/> NO	2550/30000
TTL ADD DISP	OWN TRK	:	0/30000
	OTHER TRK (CONS)	:	0/10000
	(AIS)	:	0/10000
	(TT)	:	0/10000
	(GPS BUOY)	:	0/10000
	MARK / LINE	:	0/30000
TURN KNOB, ▲▼ : SELECT PUSH KNOB : ENTER			
[0]~[9] : NO. OF PAGE ◀▶ : MOVE PAGE			
[MENU] : BACK			

4. Select [DISPLAY OWN TRACK], [DISP OTHER TRCK (CONS)] or [ADD MARK / LINE DISP.] in the internal memory block you want to load. The memory capacity and the number of currently recorded data are displayed to the right of each item.
5. Select [YES].
6. Repeat steps 4 and 5 to load other data.
7. Press the **DISP** key to close the menu. Selected data (tracks, marks, lines) appear on the screen. Note that these cannot be erased or edited.

To cancel the data display, select [NO] at step 5.

10.2.3 How to play back data from the internal memory

Data in the internal memory can be loaded to the working memory and played back on the screen. However, loaded waypoint/route and setting data will replace current data or add to current data, depending on play back method. For that reason, you may want to record the current display before replaying data.

1. Press the **MENU** key to open the main menu.
2. Select [3. USB/INTERNAL MEMORY MANAGEMENT].
3. Select [4. INTERNAL MEMORY PLAYBACK].

INTERNAL MEMORY PLAYBACK						
REC OWN TRK	:	ADD				<input type="checkbox"/> NO
REC OTHR TRK	:	ADD				<input type="checkbox"/> NO
RECORD MARK/TRACK	:	OVERWRITE	ADD			<input type="checkbox"/> NO
RECORD ROUTE/WPT	:	OVERWRITE				<input type="checkbox"/> NO
LOAD SETTING	:	OVERWRITE				<input type="checkbox"/> NO
DATA SELECTION						
DATA	OWN TR	OTR TR	MARK	WPT	ROUTE	
1:20150101094126	2000	1500	1300	70	20	
2:20150101094127	2150	1650	1350	85	22	
3:20150101094128	2700	1900	1800	135	27	
4:20150101094129	2550	1800	1550	95	25	
5:20150101094130	2600	1850	1650	120	26	
6:NO DATA						
7:NO DATA						
8:NO DATA						
9:NO DATA						
0:NO DATA						
CURRENT USAGE	OWN TRK	:	12000/30000			
	OTHER TRK (CONS)	:	1600/10000			
	(AIS)	:	3100/10000			
	(TT)	:	2800/10000			
	(GPS BUOY)	:	1200/10000			
	MARK/LINE	:	7650/30000			
TURN KNOB, ▲▼ : SELECT PUSH KNOB : ENTER						
[MENU] : BACK						
SELECT THE FILE TO PLAY BACK						

4. Select an item to replay.
5. Select [ADD] or [OVERWRITE] depending on the item selected at step 4.
[ADD]: Adds the selected data to the current display data.
[OVERWRITE]: Overwrites the current display data.
Note: When setting [RECORD MARK/TRACK] to [ADD], the selected data can not be added if the memory capacity is reached (30,000). For [REC OWN TRK] or [REC OTHR TRK], the oldest data is erased to make room for the latest. For example, when 25,000 track points for own ship are added to the current 10,000 track points, the old 5,000 track points of the current 10,000 track points are erased. Then 25,000 track points are added to the remaining 5,000 track points.
6. Repeat steps 4 and 5 to replay other data.
7. Select the data to replay from [DATA SELECTION]. The message "LOAD FILE. ARE YOU SURE? (THE SYSTEM WILL REBOOT WHEN THE FILE IS LOADED.)" appears.
8. Select [RUN] to replay the data.
9. When the message of loading end appears, push the **ENTER** knob.
10. Press the **DISP** key to close the menu.

10.2.4 How to delete data from the internal memory

To delete data from the internal memory, do the following:

1. Press the **MENU** key to open the main menu.
2. Select [3. USB/INTERNAL MEMORY MANAGEMENT].
3. Select [DELETE INTERNAL MEMORY].

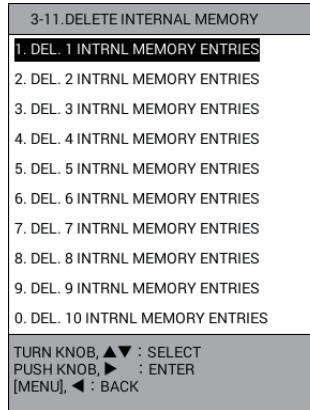

4. Select the internal memory to delete from [1. DEL. 1 INTRNL MEMORY ENTRIES] to [0. DEL. 10 INTRNL MEMORY ENTRIES]. The following confirmation message appears.

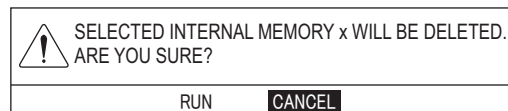

x: Number of selected internal memory

5. Select [RUN] to delete the data.
6. Press the **DISP** key to close the menu.

10.3 USB Flash Memory Operations

Note: Keep water away from the unit when the USB flash memory is inserted. The USB port is not waterproof while its cover is removed.

10.3.1 How to insert a USB flash memory

1. Pull the tab on the USB drive cover from top down to open the USB drive.

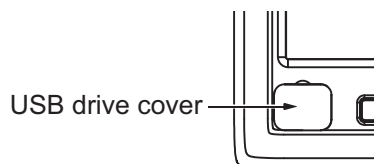

2. Connect a USB flash memory in the USB drive.

10.3.2 How to safely remove a USB flash memory



Do the following when removing a USB connection device such as a USB flash memory.

The data stored in the USB flash memory may become corrupted if the memory is not removed correctly.

1. Press the **MENU** key to open the main menu.
2. Select [3. USB/INTERNAL MEMORY MANAGEMENT].
3. Select [REMOVE USB MEMORY]. The message "USB DEVICE CAN BE SAFELY REMOVED." appears.
4. Push the **ENTER** knob.
5. Remove the USB flash memory, then close the cover.
6. Press the **DISP** key to close the menu.

10.3.3 How to save the data to a USB flash memory

Data in the working memory or the internal memory can be saved to a USB flash memory.

1. Connect a USB flash memory in the USB drive.
2. Press the **MENU** key to open the main menu.
3. Select [3. USB/INTERNAL MEMORY MANAGEMENT].
4. Select [1. USB MEMORY RECORDING].

USB MEMORY RECORDING					
REC OWN TRK	:	YES			[NO DATA]
REC OTHR TRK	:	YES			[NO DATA]
RECORD MARK/TRACK	:	YES			[NO DATA]
RECORD ROUTE/WPT	:	YES			[NO DATA]
SEL DATUM	:	[WGS-84]			TOKYO
LOAD SETTING	:	YES			[NO DATA]
DATA SELECTION					
DATA	OWN TR	OTR TR	MARK	WPT	ROUTE
RUN DATA	3500	2700	1850	95	45
1:20150101094126	2000	1500	1300	70	20
2:20150101094127	2150	1650	1350	85	22
3:INT MEMORY 3					
4:INT MEMORY 4					
5:INT MEMORY 5					
6:INT MEMORY 6					
7:INT MEMORY 7					
8:INT MEMORY 8					
9:INT MEMORY 9					
0:INT MEMORY 1 0					
CURRENT USAGE	OWN TRK	:	3500/30000		
	OTHER TRK (CONS)	:	600/10000		
	(AIS)	:	900/10000		
	(TT)	:	800/10000		
	(GPS BUOY)	:	400/10000		
	MARK/LINE	:	1850/30000		
TURN KNOB, ▲▼ : SELECT PUSH KNOB : ENTER					
[MENU] : BACK					
SELECT THE FILE TO RECORD					

5. Select an item to save.
6. Select [YES].
7. Repeat steps 5 and 6 to save other items.
8. Select [SEL DATUM].
9. Select [WGS-84] or [TOKYO].

10. To save the data in the working memory, select [RUN DATA] from [DATA SELECTION]. To save the data in the internal memory, select one of [1:XXXXXXXXXX] to [0:XXXXXXXXXX] (XXXXXXXXXX: file name) from [DATA SELECTION]. The [FILE NAME] window appears. The current date is automatically named as the file name. To change the file name, go to the next step.
11. Enter the file name (up to 15 characters) (see "How to enter alphanumeric data" on page 1-10) then select [ENTER] to show the following message.



xxxxxx: Working data or internal memory (1 to 10)

12. Select [RUN] to save the data, which takes max. one minute. When the screenshot data is large, more time is necessary. For screenshot procedures, see section 10.5.
Note: The time for the track data is saved in UTC.
13. Push the **ENTER** knob.
14. Press the **DISP** key to close the menu.

10.3.4 How to play back the data from the USB flash memory

Data in the USB flash memory can be loaded to the working memory and played back on the screen. However, loaded waypoint/route and setting data will replace current data or add to current data, depending on play back method. For that reason, you may want to record the current display before replaying data.

1. Connect a USB flash memory in the USB drive.
2. Press the **MENU** key to open the main menu.
3. Select [3. USB/INTERNAL MEMORY MANAGEMENT].
4. Select [2. USB MEMORY PLAYBACK].

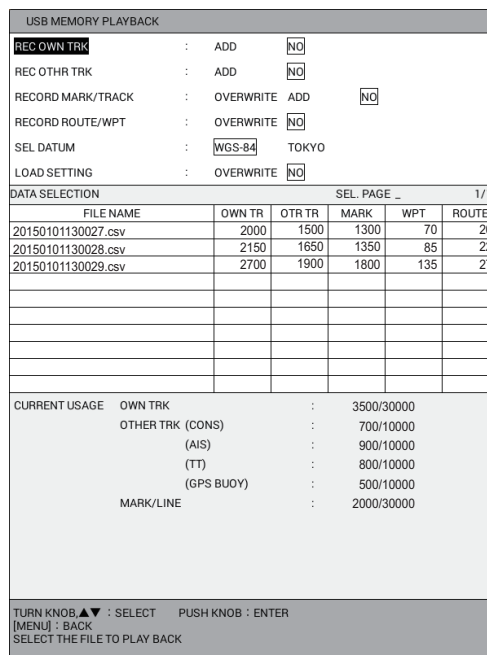

5. Select an item to replay.
Note: If replaying the setting data ([LOAD SETTING]) and others at the same time, others (tracks, marks, lines, routes, waypoints) may not be replayed. Replay others at first, then the setting data.

10. HOW TO RECORD, PLAY BACK DATA

6. Select [ADD] or [OVERWRITE] depending on the item selected at step 5.
 [ADD]: Adds the selected data to the current display data.
 [OVERWRITE]: Overwrites the current display data.
Note: When setting [RECORD MARK/TRACK] to [ADD], the selected data can not be added if the memory capacity is reached (30,000). For [REC OWN TRK] or [REC OTHR TRK], the oldest data is erased to make room for the latest. For example, when 25,000 track points for own ship are added to the current 10,000 track points, the old 5,000 track points of the current 10,000 track points are erased. Then 25,000 track points are added to the remaining 5,000 track points.
7. Repeat step 5 and step 6 to replay other data.
8. Select [SEL DATUM].
9. Select [WGS-84] or [TOKYO].
10. Select the file to replay from [DATA SELECTION]. The message "LOAD FILE. ARE YOU SURE? (THE SYSTEM WILL REBOOT WHEN THE FILE IS LOADED.)" appears.
11. Select [RUN] to replay the data, which takes max. one minute. When the screenshot data is large, more time is necessary. For screenshot procedures, see section 10.5.
12. Push the **ENTER** knob.
13. Press the **DISP** key to close the menu.

10.3.5 How to transfer the data from the USB flash memory

Data in the USB flash memory can be transferred to the internal memory.

1. Connect a USB flash memory in the USB drive.
2. Press the **MENU** key to open the main menu.
3. Select [3. USB/INTERNAL MEMORY MANAGEMENT].
4. Select [5. TRF USB TO INT MEMORY].

TRF USB TO INT MEMORY						
REC OWN TRK	:	YES	NO DATA			
REC OTHR TRK	:	YES	NO DATA			
RECORD MARK/TRACK	:	YES	NO DATA			
RECORD ROUTE/WPT	:	YES	NO DATA			
SEL DATUM	:	WGS-84	TOKYO			
LOAD SETTING	:	YES	NO DATA			
DATA SELECTION			SEL. PAGE		1/1	
FILE NAME	OWN TR	OTR TR	MARK	WPT	ROUTE	
20150101130027.csv	2000	1500	1300	70	20	
20150101130028.csv	2150	1650	1350	85	22	
20150101130029.csv	2700	1900	1800	135	27	
CURRENT USAGE	OWN TRK	:	3500/30000			
	OTHER TRK (CONS)	:	700/10000			
	(AIS)	:	900/10000			
	(TT)	:	800/10000			
	(GPS BUOY)	:	500/10000			
	MARK/LINE	:	2000/30000			
ROTATE KNOB,▲▼ : SELECT PUSH KNOB : ENTER [MENU] : BACK SELECT FILE TO TRANSFER.						

5. Select an item to transfer.
6. Select [YES].
7. Repeat step 5 and step 6 to transfer other data.
8. Select [SEL DATUM].
9. Select [WGS-84] or [TOKYO].
10. Select the file to transfer from [DATA SELECTION]. The [COMMENT] window appears. The current date is automatically named as the file name. To change the file name, go to the next step.
11. Enter the file name (up to 15 characters) (see "How to enter alphanumeric data" on page 1-10) then select [ENTER]. The message "TRANSFER XXXXXX.csv TO INT MEMORY. ARE YOU SURE?" (XXXXXX: file name) appears.
12. Select [RUN] to transfer the data.
13. Push the **ENTER** knob.
14. Press the **DISP** key to close the menu.

10.4 Backup Data

10.4.1 How to backup the data automatically

This equipment can backup the data (tracks, marks/lines, routes/waypoints and setting data) automatically when turning the power on. There are two backup methods:

- Automatic backup by a USB flash memory
- Automatic backup by the internal memory

Note: The start-up sequence (until the normal display appears) may take longer when this function is active.

How to backup the data to a USB flash memory automatically

Note: To activate this function, connect a USB flash memory in the USB drive before turning the power on.

1. Press the **MENU** key to open the main menu.
2. Select [3. USB/INTERNAL MEMORY MANAGEMENT].
3. Select [7. AUTO BACKUP].

AUTO BACKUP		
USB MEMORY	: YES	<input type="checkbox"/>
INTERNAL MEMORY	: YES	<input type="checkbox"/>
TURN KNOB, ▲▼ : SELECT PUSH KNOB : ENTER		
[MENU] : BACK		

4. Select [USB MEMORY].
5. Select [YES].
6. Press the **DISP** key to close the menu. Whenever turning the power on, the data is automatically saved to the "Backup" folder in the USB flash memory.

Note: When setting [USB MEMORY] in the [AUTO BACKUP] menu to [YES], the backup starts after the "attention" screen disappears at the start-up. A message about "backup in progress" appears while backup is being done.

How to backup the data to the internal memory automatically

1. Press the **MENU** key to open the main menu.
2. Select [3. USB/INTERNAL MEMORY MANAGEMENT].
3. Select [7. AUTO BACKUP].
4. Select [INTERNAL MEMORY].
5. Select [YES].
6. Press the **DISP** key to close the menu. Whenever turning the power on, the data is automatically saved to the internal memory.

Note: When setting [INTERNAL MEMORY] in the [AUTO BACKUP] menu to [YES], the backup starts after the “attention” screen disappears at the start-up. A message about “backup in progress” appears while backup is being done.

10.4.2 How to backup the data manually

There are two manual backup methods:

- Backup by a USB flash memory
- Backup by the internal memory

How to backup the data to a USB flash memory manually

1. Connect a USB flash memory in the USB drive.
2. Press the **MENU** key to open the main menu.
3. Select [3. USB/INTERNAL MEMORY MANAGEMENT].
4. Select [8. SAVE BACKUP DATA].

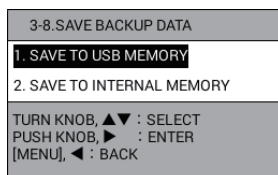

5. Select [1. SAVE TO USB MEMORY]. The following message appears.

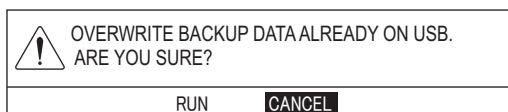

6. Select [RUN] to backup the data. The message "TRANSFERRING. PLEASE WAIT." appears.
7. After the message "TRANSFER COMPLETED" appears, push the **ENTER** knob.
8. Press the **DISP** key to close the menu.

How to backup the data to the internal memory manually

1. Press the **MENU** key to open the main menu.
2. Select [3. USB/INTERNAL MEMORY MANAGEMENT].
3. Select [8. SAVE BACKUP DATA].

4. Select [2. SAVE TO INTERNAL MEMORY]. The following message appears.

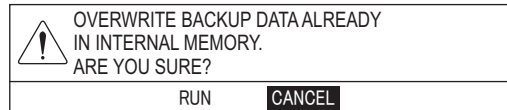

5. Select [RUN] to backup the data. The message "TRANSFERRING. PLEASE WAIT." appears.
6. After the message "TRANSFER COMPLETED" appears, push the **ENTER** knob.
7. Press the **DISP** key to close the menu.

10.4.3 How to load the backup data

There are two methods to load the backup data:

- Load the backup data from a USB flash memory
- Load the backup data from the internal memory

How to load the backup data from a USB flash memory

1. Connect a USB flash memory in the USB drive.
2. Press the **MENU** key to open the main menu.
3. Select [3. USB/INTERNAL MEMORY MANAGEMENT].
4. Select [9. LOADING BACKUP DATA].

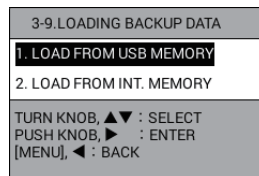

5. Select [1. LOAD FROM USB MEMORY]. The following message appears.

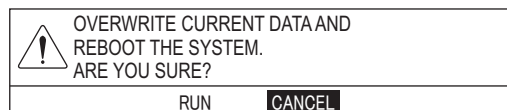

6. Select [RUN] to load the backup data. After two messages appears, the system restarts.

How to load the backup data from the internal memory

1. Press the **MENU** key to open the main menu.
2. Select [3. USB/INTERNAL MEMORY MANAGEMENT].
3. Select [9. LOADING BACKUP DATA].
4. Select [2. LOAD FROM INT. MEMORY]. The following message appears.

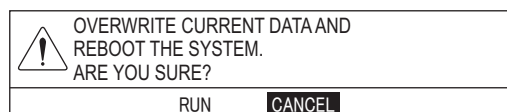

5. Select [RUN] to load the backup data. After two messages appear, the system restarts.

10.5 Screenshot (Screen Capture)

This system has a screen capture function. The screenshot data is saved in the internal memory. Also, you can transfer the data to a USB flash memory as follows:

1. Assign screenshot function to a function key (see subsection 1.7.2). The default function for the **F2** key is screenshot.
2. Press the function key assigned the screenshot function (e.g. **F2** key) when the picture to copy is displayed. The message "SAVED SCREENSHOT" appears.
Note: Do not operate any keys until the message disappears.
3. Connect a USB flash memory in the USB drive.
4. Press the **MENU** key to open the main menu.
5. Select [3. USB/INTERNAL MEMORY MANAGEMENT].
6. Select [0. MANAGEMENT OF SCREENSHOT]. The preview for the highlighted file is displayed on the upper side of the screen.

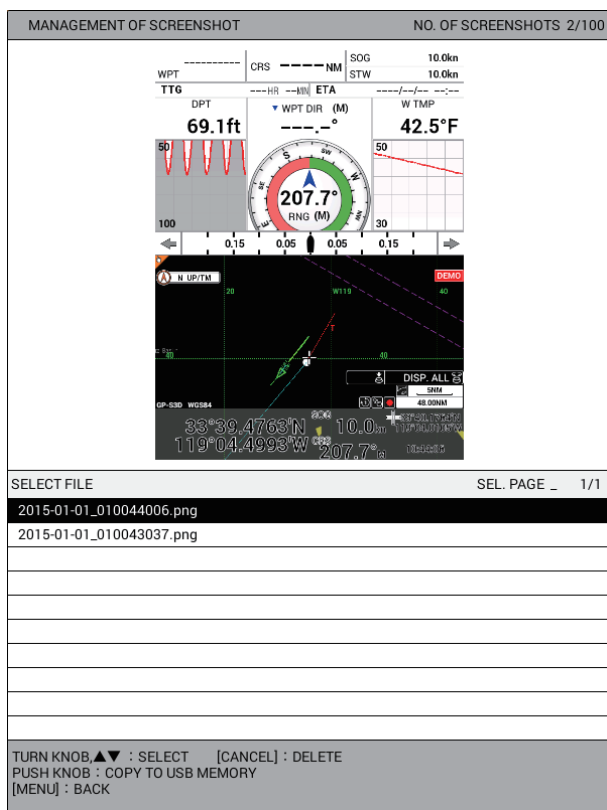

7. Push the **ENTER** knob to show the following message.

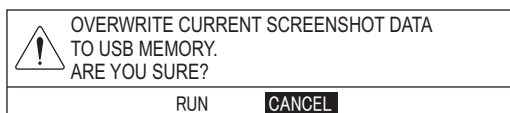

8. Select [RUN] to transfer the screenshot data to the USB flash memory. The message "TRANSFERRING. PLEASE WAIT." appears.
9. After the message "TRANSFER COMPLETED" appears, push the **ENTER** knob.
10. Press the **DISP** key to close the menu.

10.6 How to Automatically Save NMEA 0183 Sentences (Data Logger)

The data logger function enables automatic saving of NMEA 0183 sentences with timestamps to a USB flash memory.

Note 1: Enter the ZDA or RMC sentences to check the time difference from the timestamps.

Note 2: The data logger and line monitor log functions (see section 9.7) cannot be used simultaneously.

How to activate the data logger function

1. Insert a USB flash memory formatted in FAT32 into the USB1 port located on the back of the unit.
2. Press the **MENU** key to open the main menu.
3. Select [0. SYSTEM SETTING].
4. Select [0. MAINTENANCE].
5. Select [7. OP MODE SETTING].

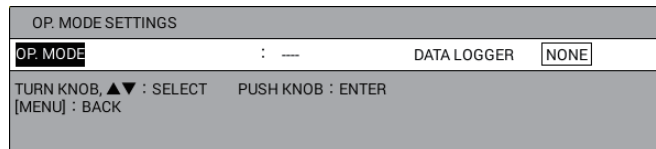

6. Select [OP. MODE].
7. Select [DATA LOGGER].
The data logger function activates and starts saving data.
8. Press the **DISP** key to close the menu.

The icon () appears at the bottom of the screen when the data logger function is activated.

Note 1: The storage location (GP-3700/MonitorLog) and file name format (GP-3700_AA_CCCC_YYYYMMDDHHMMSS.log) are the same for both the line monitor and data logger functions.

- AA: Shows [Tx] for data transmitted by GP-3700/F and [Rx] for data received.
- CCCC: Shows serial port number [Port1], [port2], or [Port3].
- YYYYMMDDHHMMSS: Shows the file creation time (year-month-day-hour-minute-second; local time).

Note 2: The data logger function is paused under any of following conditions.

- When the [OP. MODE] setting is changed during the data saving.
- When the USB flash memory data capacity runs out during the data saving.
- When the USB flash memory is removed during the data saving.

How to safely remove a USB flash memory for data logger



Do the following when removing a USB connection device such as a USB flash memory.

The data stored in the USB flash memory may become corrupted if the memory is not removed correctly.

1. Press the **MENU** key to open the main menu.
2. Select [3. USB/INTERNAL MEMORY MANAGEMENT].
3. Select [REMOVE USB MEMORY (REAR)]. The message "USB DEVICE CAN BE SAFELY REMOVED." appears.
4. Push the **ENTER** knob.
5. Remove the USB flash memory for data logger.
6. Press the **DISP** key to close the menu.

10.7 How to Load the Data from Other Equipment

Data in other equipment can be loaded to the internal memory.

Note 1: Request a qualified technician to load the data from other equipment. Contact your dealer.

Note 2: When using a commercial USB floppy drive, insert a floppy disk to the drive before connecting the drive to the GP-3700F. When changing a floppy disk, reconnect the drive to the GP-3700F.

1. Connect a USB device, in which the data to load are saved, in the USB drive.
2. Press the **MENU** key to open the main menu.
3. Select [3. USB/INTERNAL MEMORY MANAGEMENT].
4. Select [IMPORT EXTERNAL DATA].

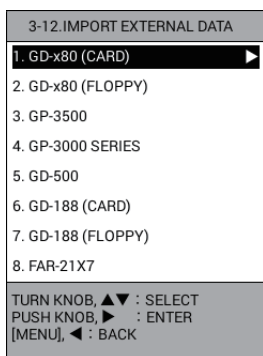

GD-x80: GD-280, GD-380,
GD-680, GD-280BB

Note: [2. GD-x80 (FLOPPY)] and [7. GD-188 (FLOPPY)] are unavailable.

5. Select the model type to load.

GD-x80 (CARD)					
REC OWN TRK	:	YES	NO DATA		
REC OTHR TRK	:	YES	NO DATA		
RECORD MARK/TRACK	:	YES	NO DATA		
RECORD ROUTE/WPT	:	YES	NO DATA		
SEL DATUM	:	WGS-84	TOKYO		
DATA SELECTION			SEL. PAGE		
FILE NAME	OWN TR	OTR TR	MARK	WPT	ROUTE
1:20150101094126	2000	1500	1300	70	20
2:20150101094127	2150	1650	1350	85	22
3:20150101094128	2700	1900	1800	135	27
4:20150101094129	2550	1800	1550	95	25
5:20150101094130	2600	1850	1650	120	26
CURRENT USAGE	OWN TRK	:	12000/30000		
	OTHER TRK (CONS)	:	1600/10000		
	(AIS)	:	3100/10000		
	(TT)	:	2800/10000		
	(GPS BUOY)	:	1200/10000		
	MARK/LINE	:	7650/30000		
TURN KNOB, ▲▼ : SELECT PUSH KNOB : ENTER					
[MENU] : BACK					
SELECT FILE TO TRANSFER.					

Example: [1. GD-x80 (CARD)]

6. Select an item to load.
7. Select [YES].
8. Repeat steps 6 and 7 to load other items.
9. Select [SEL DATUM].
10. Select [WGS-84] or [TOKYO].
11. Select the file to load from [DATA SELECTION]. The confirmation message appears.
12. Select [RUN] to load the data. The message "TRANSFERRING. PLEASE WAIT." appears.

Note: It may take approx. 20 minutes to transfer the data according to the selected equipment.
13. After the message "TRANSFER COMPLETED" appears, push the **ENTER** knob.
14. Press the **DISP** key to close the menu.

10. HOW TO RECORD, PLAY BACK DATA

This page is intentionally left blank.

11. ECHO SOUNDER

11.1 How the Echo Sounder Operates

The echo sounder calculates the distance between its transducer and underwater objects like fish, lake bottom or seabed. The results are shown in different colors or shades of gray according to echo strength.

The ultrasonic waves transmitted through water move at a constant speed of approximately 4800 feet (1500 meters) per second. When a sound wave "hits" an underwater object like fish or sea bottom, part of the sound wave is reflected toward the source. To find the depth to an object, the echo sounder calculates the time difference between the transmission of a sound wave and the time the reflected sound wave is received.

The picture displayed by the echo sounder contains a series of vertical scan lines. Each line is a "picture" of the objects under the boat. The series of pictures are put side-by-side across the screen to show the contours of the bottom and echoes from fish. The amount of history of objects that have moved under the boat can be less than a minute to more than one minute depending on the picture advance speed.

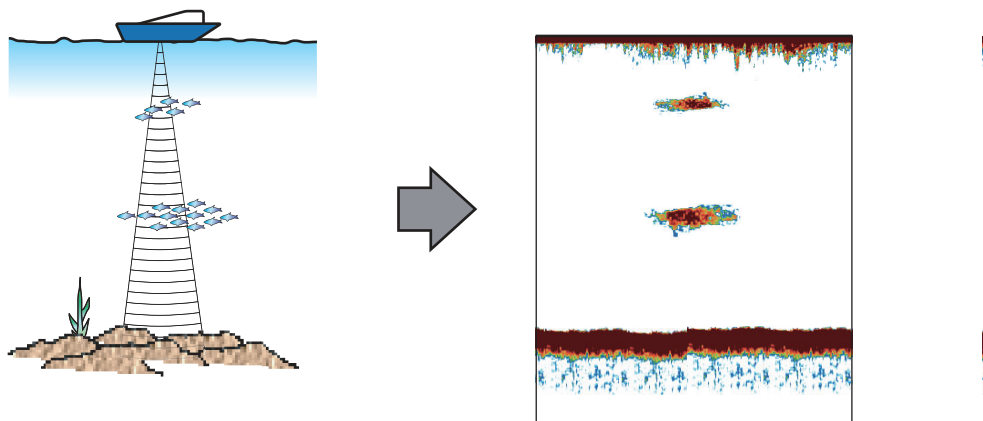

Note: Unless otherwise noted, the following procedures assume the echo sounder screen is displayed. The menu items for the echo sounder are only accessible when the echo sounder screen is displayed.

11.2 Echo Sounder Displays

The echo sounder is displayed in full screen or combination with the plotter screen.

There are nine display modes as below:

- Single frequency display
- Marker zoom display
- Bottom lock display
- A-scope display
- Plotter/echo sounder display
- Dual frequency display
- Bottom zoom display
- Bottom discrimination display (seabed composition)
- Mix display

For the display setting, see section 1.4.

11.2.1 Single frequency display (50 kHz or 200 kHz)

Low frequency (50 kHz)

The sounder uses ultrasonic signals to detect bottom conditions. The lower the frequency of the signal, the wider the detection area. Therefore, the 50 kHz frequency is useful for general detection and judging bottom condition.

High frequency (200 kHz)

The higher the frequency of the ultrasonic signal, the better the resolution. For this reason the 200 kHz frequency is ideal for detailed observation of schools of fish.

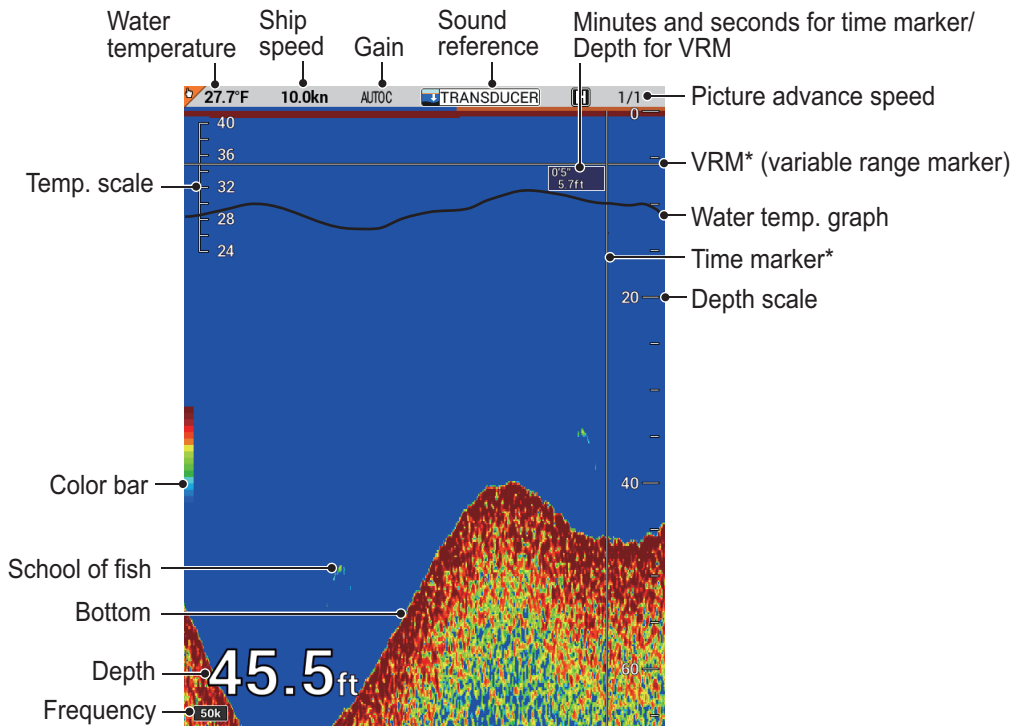
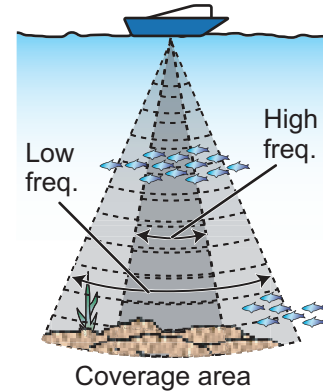

*: In this chapter, the combination of VRM and time marker on the echo sounder display is referred to as “cursor”.

11.2.2 Dual frequency display

The dual frequency display provides both low and high frequency pictures. For vertical split screen, the low frequency picture (50 kHz) is displayed on the left half, the high frequency picture (200 kHz) on the right half. For horizontal split screen, the low frequency picture (50 kHz) is displayed on the top half, the high frequency picture (200 kHz) on the bottom half. Use the dual frequency display to compare the same picture with two different sounding frequencies.

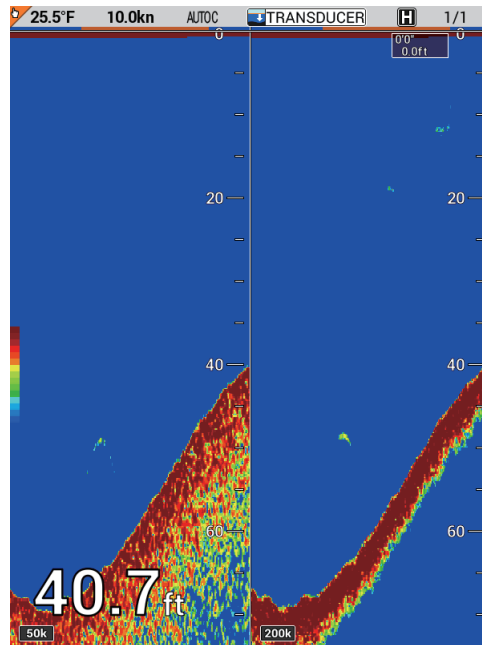

Frequency	Beam width	Bottom tail
50 kHz	Wide	Long
200 kHz	Narrow	Short

11.2.3 Marker zoom display (50 kHz or 200 kHz)

The marker zoom display expands a selected area of the normal echo sounder picture on the left half of the screen. You may specify the portion to expand by operating the VRM. The area between the VRM and zoom marker is expanded. (You may set the zoom range. For further details, see section 11.20.) This mode is useful for determining the size of fish in the middle water.

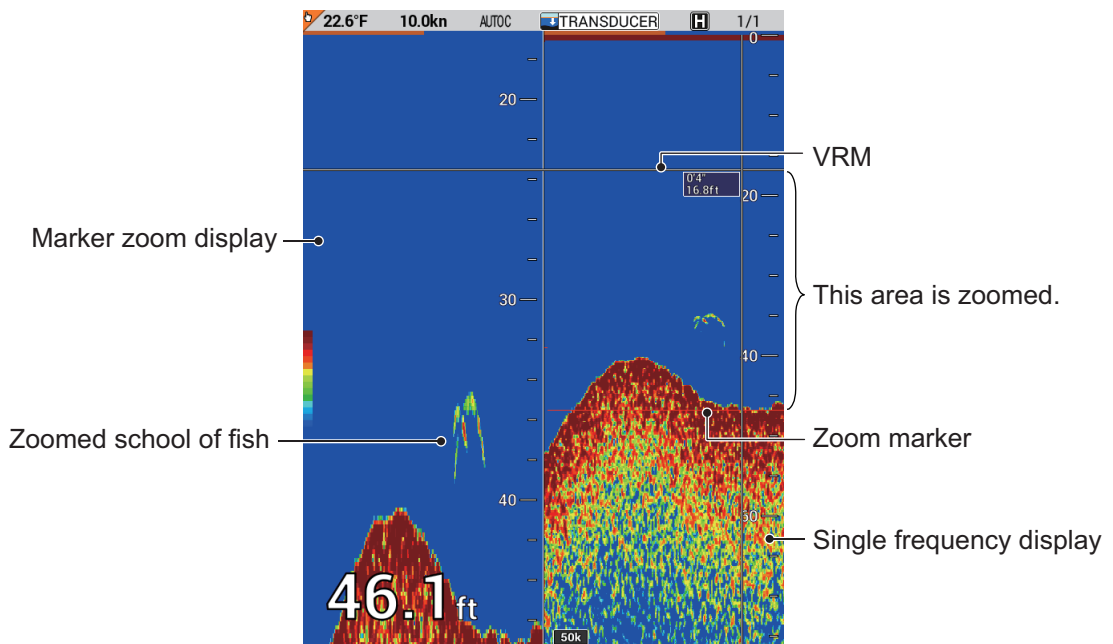

11.2.4 Bottom zoom display (50 kHz or 200 kHz)

The bottom-zoom display expands bottom and bottom fish echoes by the zoom range selected on the menu (see section 11.20). This mode is useful for determining bottom contour. When the bottom depth increases, the display automatically shifts to keep the bottom echo at the lower part of the screen.

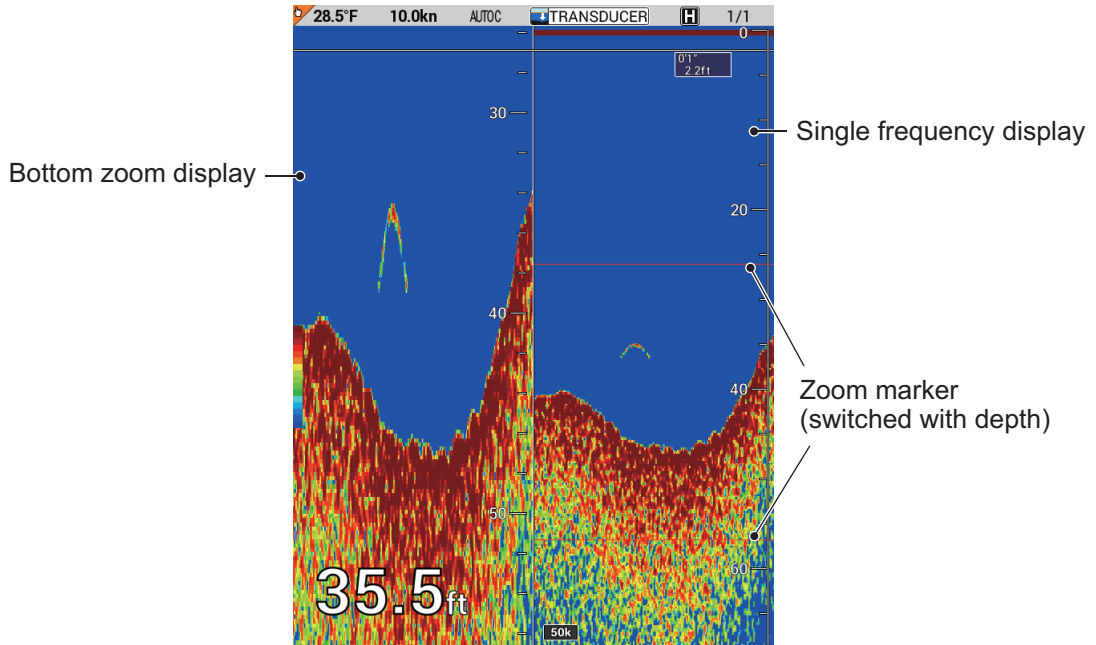

11.2.5 Bottom lock display (50 kHz or 200 kHz)

The bottom-lock display provides a normal picture on the right half of the screen and a 2 to 10 meters (7 to 30 feet) wide layer in contact with the bottom is expanded on the left half of the screen. This mode is useful for discriminating bottom fish from the bottom echo. You may select the bottom lock range. Refer to section 11.20.

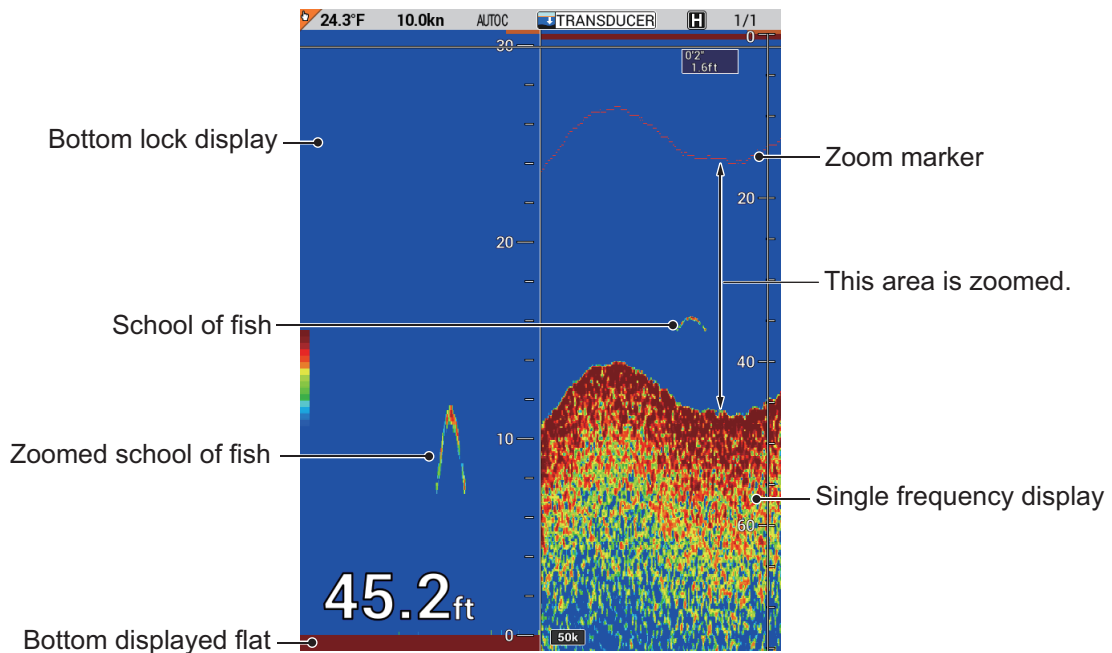

11.2.6 Bottom discrimination display (50 kHz or 200 kHz)

The bottom discrimination (seabed composition) display shows the normal display as the right half, the left half of the display is split in half horizontally with the bottom zoom display on the upper half and the bottom discrimination display on the lower half. A bottom displayed with a short echo tail usually means it is a soft, sandy bottom. A long echo tail means a hard bottom.

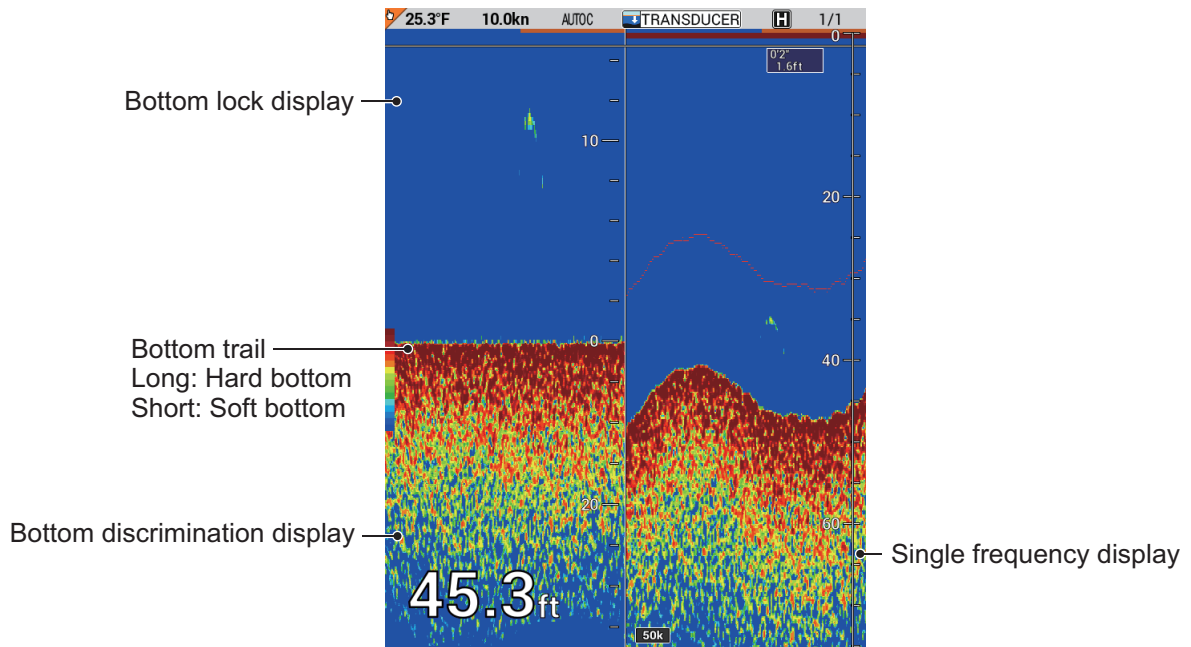

11.2.7 A-scope display (50 kHz, 200 kHz or dual frequency)

The A-scope display shows echoes at each transmission with amplitudes and tones proportional to their intensities, on the right of the screen. It is useful for estimating fish species and seabed composition.

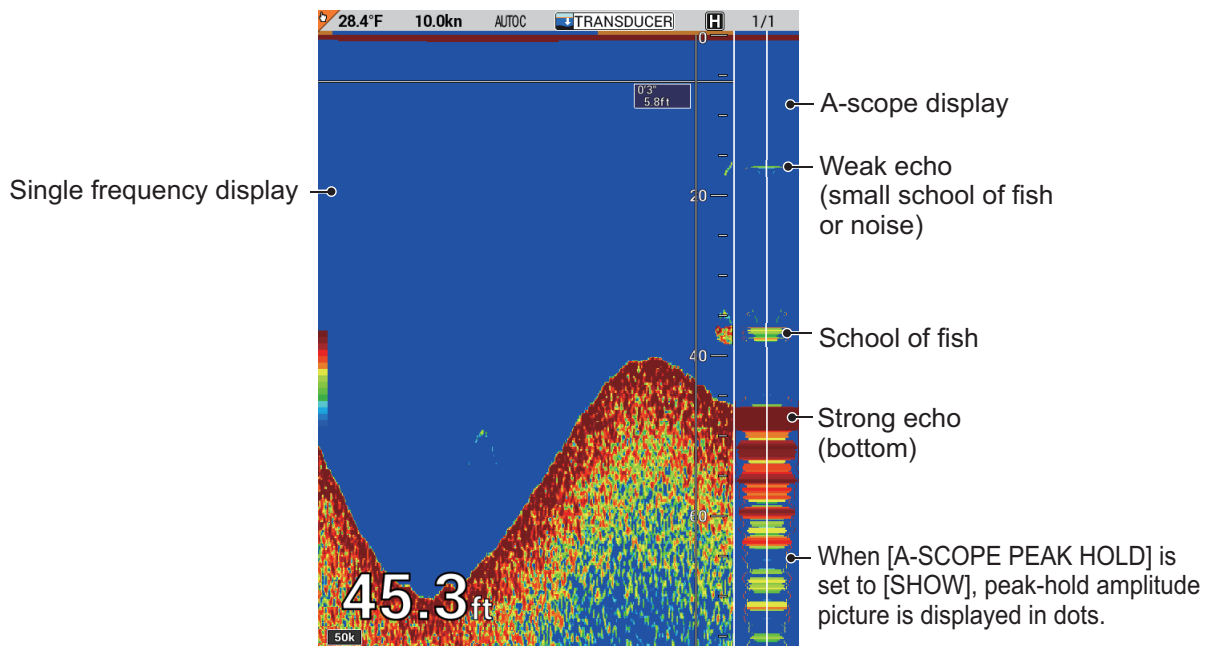

Peak hold display

The peak hold function shows “normal” A-scope display plus peak-hold amplitude picture in dots. The peak hold is cleared every five seconds.

Note: When the strong echo appears after weak echo at the same depth, the peak-hold amplitude picture is updated. When the weak echo appears after strong echo at the same depth, the peak-hold amplitude picture is not updated because strong echo remains.

1. Press the **MENU** key to open the main menu.
2. Select [9. ECHO SOUNDER SETTING].

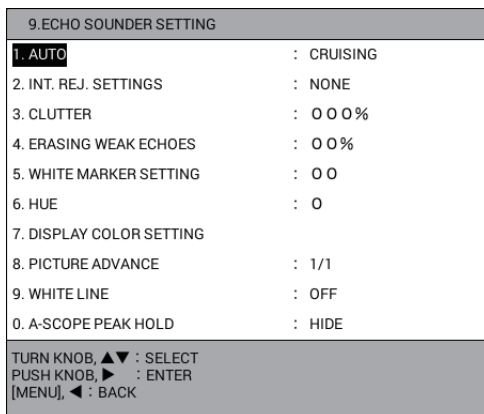

3. Select [0. A-SCOPE PEAK HOLD].

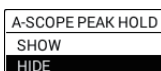

4. Select [SHOW].
5. Press the **DISP** key to close the menu.

To deactivate the peak hold display, select [HIDE] at step 4.

11.2.8 Mix display

This mode compares echo intensity between low and high frequencies, and displays echoes from tiny fish in discriminative colors. This is done by utilizing the fact that tiny fish return a stronger echo against a high frequency rather than a low frequency. This is done as below.

- If a high frequency echo is stronger than the corresponding echo on the low frequency, the high frequency echo is displayed.
- If the low frequency echo is stronger than or equal to the high frequency echo, it is less likely to be a tiny fish and therefore is displayed in blue.
- If the echoes on both frequencies have the intensity corresponding to reddish brown or red, they are displayed in reddish brown or red: this is necessary to display the zero line and bottom in reddish brown or red.

In other words, the echoes displayed in orange thru light-blue may be considered to be tiny fish such as whitebait. [50/200] is displayed at the bottom left of the mixed screen.

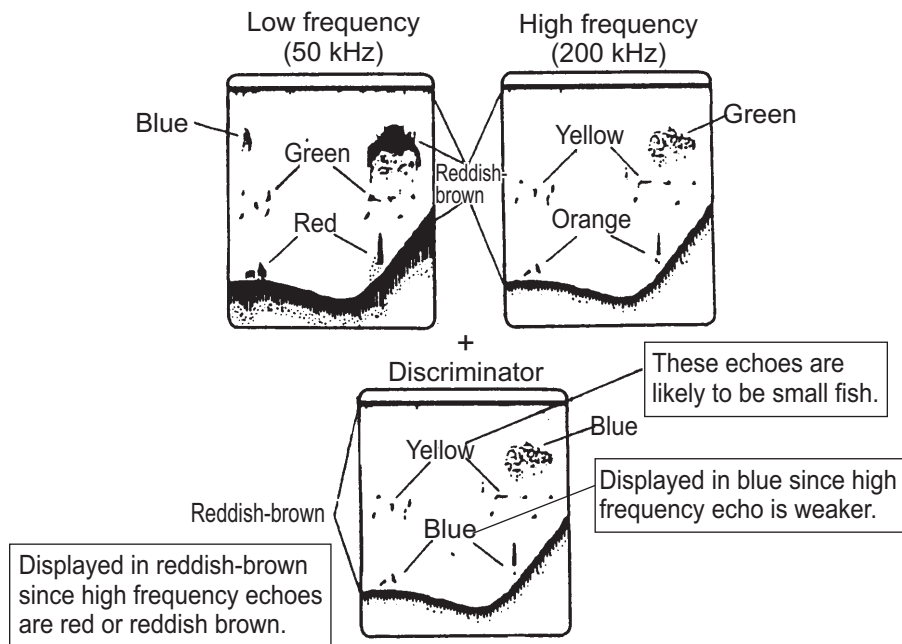

11.2.9 Plotter/echo sounder display

This display provides the plotter display and the echo sounder display (single or dual frequency) at the same time. It is useful for searching schools of fish at cruising speed. Note that vertical division is also available.

- Horizontal two-way split: Plotter display is displayed on the upper half of the screen and echo sounder display (single or dual frequency) on the bottom half.
- Vertical two-way split: Plotter display or echo sounder display (single frequency) is displayed on the left half or right half of the screen.
- Three-way split: Plotter display is displayed on the upper left or right of the screen and echo sounder display (single or dual frequency) on the bottom half.

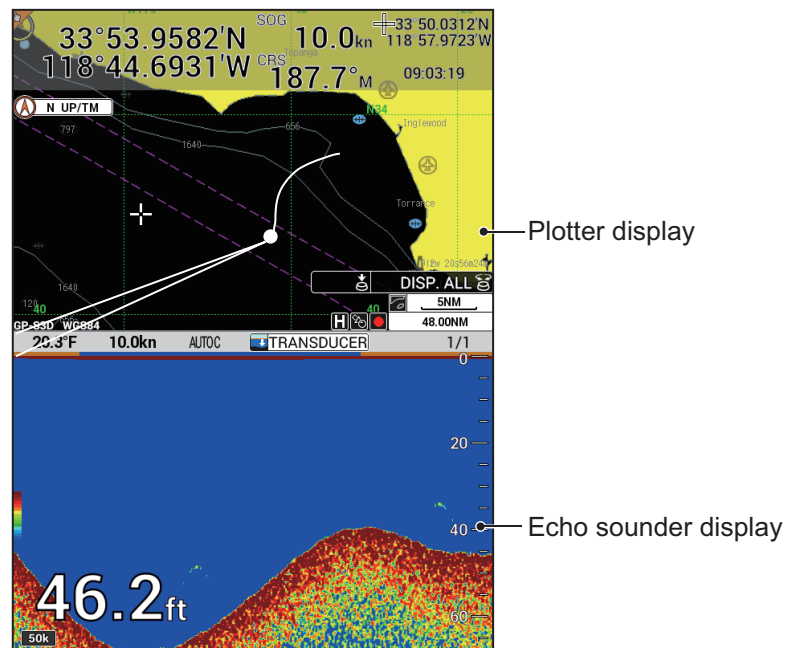

11.3 Automatic Echo Sounder Operation

The automatic fish finder function automatically adjusts the gain, clutter, and range, to free you to do other tasks. The main features of the automatic mode are as shown below.

- Range is adjusted automatically to show the bottom echo.
- Gain adjusts the sensitivity of the receiver to show the bottom echo in reddish-brown (default color arrangement).
- Clutter automatically reduces low-level noise like plankton.

Two types of automatic sounder modes are available: [CRUISING] and [FISHING]. [CRUISING] is for tracking the bottom, and [FISHING] is for searching schools of fish. It is useful to select [CRUISING] until arriving at fishing ground, then select [FISHING] at the fishing ground.

11.3.1 How to select an automatic echo sounder mode

1. Press the **MENU** key to open the main menu.
2. Select [9. ECHO SOUNDER SETTING].
3. Select [1. AUTO] to show the [AUTO] window.



4. Select [CRUISING] or [FISHING]. [AUTOC] or [AUTOF] appears at the top of the echo sounder display depending on your selection.
5. Press the **DISP** key to close the menu.

Note: Manual SHIFT and CLUTTER functions are inoperative in the automatic mode.

11.3.2 How to offset the base range or the gain

How to offset the base range

The basic range in the automatic mode can be offset to view the bottom in detail.

1. Press the **RANGE** key to show the [BTM DISP RNG U/LIM] window.

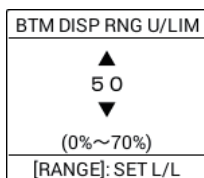

Note: The [BTM DISP RNG] window closes automatically when there is no operation for 10 seconds.

2. Set an offset value for upper limit (5% steps).
3. Press the **RANGE** key again to show the [BTM DISP RNG L/LIM] window.



Note 1: The [BTM DISP RNG] window closes automatically when there is no operation for 10 seconds.

Note 2: The maximum value for upper limit and the minimum value for lower limit vary depending on the setting value. The setting value for upper limit plus 15 equals the minimum value for lower limit.

4. Set an offset value for lower limit (5% steps).
5. Press the **RANGE** key to close the window. The setting window closes automatically after 10 seconds without pressing the **RANGE** key.

Note: The **RANGE** key can be programmed for a different function (default setting: [FISH FINDER DEPTH RANGE]).

How to offset the gain

The gain can be offset in the automatic mode to fine tune the picture.

1. Press the **GAIN** key to show the [AUTO GAIN OFFSET(LF)] window. To show the setting window for high frequency, press the **GAIN** key again.



Note: The [AUTO GAIN OFFSET] window closes automatically when there is no operation for 10 seconds.

2. Set an offset value (setting range: -5 to +5).
3. Press the **GAIN** key to close the window. If setting an offset only for low frequency, press the **GAIN** key twice to close the setting window. The setting window closes automatically after 10 seconds without pressing the **GAIN** key.

Note: The **GAIN** key can be programmed for a different function (default setting: [FISH FINDER GAIN]).

11.4 Manual Echo Sounder Operation

Use the manual operation to see schools of fish and the bottom echo with a fixed gain and range setting.

11.4.1 How to activate the manual echo sounder mode

1. Press the **MENU** key to open the main menu.
2. Select [9. ECHO SOUNDER SETTING].
3. Select [1. AUTO] to show the [AUTO] window.
4. Select [MANUAL]. "MANUAL" appears at the top of the echo sounder display.
5. Press the **DISP** key to close the menu.

11.4.2 How to select the display range

The basic range may be selected with the **RANGE** key, from the eight ranges shown in the table below. (These eight ranges may be programmed as desired. For details, see section 11.20.)

Unit	Basic range							
	1	2	3	4	5	6	7	8
m	5	10	20	40	80	150	300	500
ft	15	30	60	120	200	400	1000	1500
fm	3	5	10	20	40	80	150	300

1. Press the **RANGE** key to show the [FISH FINDER RANGE] window.

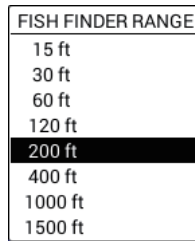

Note: The [FISH FINDER RANGE] window closes automatically when there is no operation for 10 seconds.

2. Select a range. When selecting 200 ft, for example, the subsea echo under 200 ft from the bottom side of the transducer is displayed on the screen.

Note: The **RANGE** key can be programmed for a different function (default setting: [FISH FINDER DEPTH RANGE]).

11.4.3 How to shift the display range

The shift function determines the start depth of the picture. Start depth (shift) is shown at the top of the screen.

Note: This function is not available in automatic mode.

1. Press the **SHIFT** key to show the [FISH FINDER SHIFT] window.

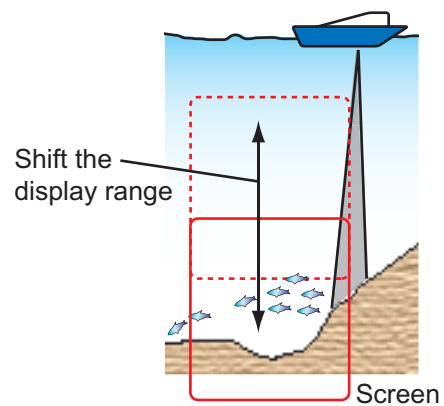
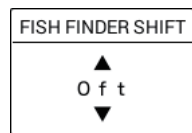

Note: The [FISH FINDER SHIFT] window closes automatically when there is no operation for 10 seconds.



2. Set the shift value.

Note 1: When setting the shift value greater than depth, the echo is not displayed.

Note 2: The **SHIFT** key can be programmed for a different function (default setting: [FISH FINDER SHIFT]).

11.4.4 How to adjust the gain

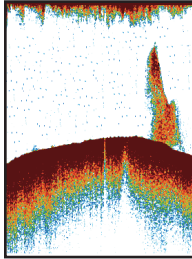
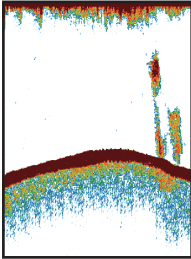
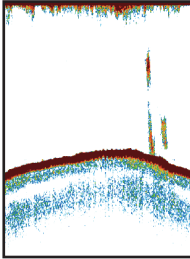
The gain controls how echoes of different strengths are displayed. Set the gain to show a slight amount of noise on the screen. Increase the gain for greater depths and lower the gain for shallow waters.

 CAUTION	 Gain too high	 Gain proper	 Gain too low
 Use the proper gain setting. Incorrect gain may produce wrong depth indication, possibly resulting in a dangerous situation.			

1. Press the **GAIN** key to show the [FISH FINDER GAIN (HF)] window. To show the setting window for low frequency, press the **GAIN** key again.

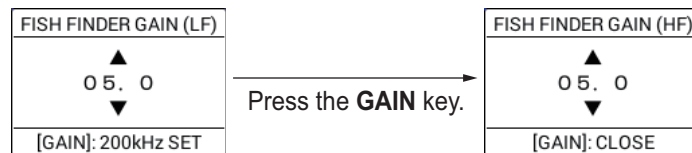

Note 1: The [FISH FINDER GAIN] window closes automatically when there is no operation for 10 seconds.

Note 2: For the dual frequency display, select the frequency to adjust by pressing the **GAIN** key then go to step 2.

2. Set the gain to show a slight amount of noise on the screen (setting range: 0 to 10.0, 0.5 step).
3. Press the **GAIN** key to close the window. If setting the gain only for low frequency (50 kHz), press the **GAIN** key twice to close the setting window. The setting window closes automatically after 10 seconds without pressing the **GAIN** key.

Note: The **GAIN** key can be programmed for a different function (default setting: [FISH FINDER GAIN]).

11.5 How to Measure Depth, Time Between Locations

You can measure the depth to an object with the VRM. Also, you can measure the time from the right edge to a location. For example, you can measure how many minutes ago an echo appeared.

Press the **CURSOR ON/OFF** key to turn on/off the VRM/time marker.

- **Depth:** Rotate the trackball in upward-downward direction to shift the VRM.
- **Time:** Rotate the trackball in left-right direction to move the time marker to measure the elapsed time.

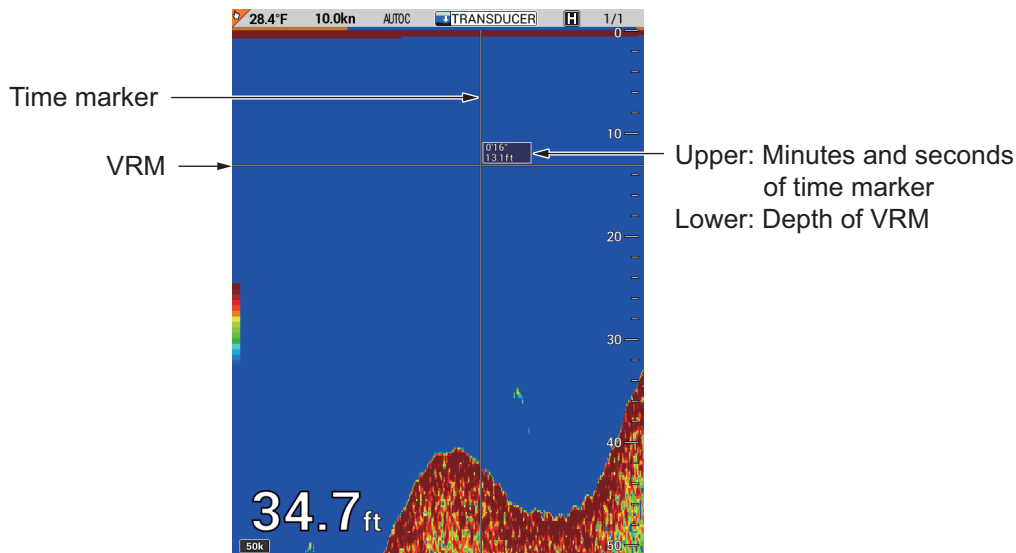

To measure depth or time in the plotter/echo sounder display, follow the procedure below.

1. Long-press the **CURSOR ON/OFF** key to enable trackball operation on the echo sounder display. At this time the track cursor ([]) appears on the ship's track line of the plotter display and it denotes the approximate geographical position of the time marker.
2. Operate the trackball to place the time marker on the school of fish desired, and then press the applicable numeric key among **1** to **8** to mark the location of the school of fish on the plotter display. Also, a vertical line is entered at the time marker position on the echo sounder display. The color of the line is the seventh color from the top of the color bar in the 64 color display, the top color of the color bar in the 16 color display. Waypoint can be entered at track cursor position similarly by pressing the **WPT** key.
3. Long-press the **CURSOR ON/OFF** key to erase the track cursor. The trackball operation is available on the plotter display.

11.6 How to Enter a Mark on the Display

You can mark the geographical location of a school of fish on the plotter display through the echo sounder display by pressing a numeric key among **1** to **8**.

- **Echo sounder display**

When the cursor is turned on, a vertical line is entered at the time marker position of the echo sounder display. On the plotter display, the selected mark or number is entered at the position the moment the key is pressed. When the cursor is turned off, a vertical line is entered at the right edge of the echo sounder display. On the plotter display, the selected mark or number is entered at the own ship position the moment the key is pressed. The color of this line depends on the number of display colors used. It is the seventh color from the top of color bar in the 64-color display, or the top color in the 16-color display.

- **Plotter/echo sounder display**

When the cursor is turned on, a vertical line is entered at the time marker position of the echo sounder display. On the plotter display, the selected mark or number is entered at the cursor position. When the cursor is turned off, a vertical line is entered at the right edge of the echo sounder display. On the plotter display, the selected mark or number is entered at the own ship position.

11.7 How to Reduce Interference

Interference from other fish finders and electrical equipment appear on the screen as shown in the illustration below. When these types of interference appear on the screen, use the interference rejector to reduce the interference.

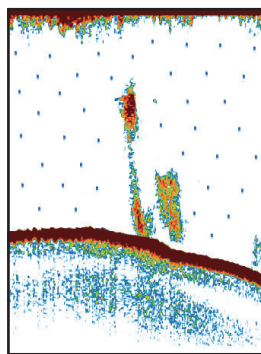

Interference from
other sounder

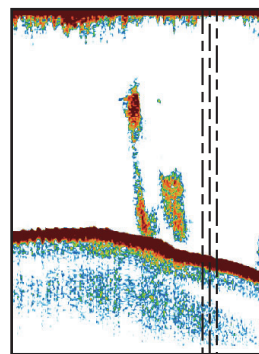

Interference from
electrical equipment

1. Press the **MENU** key to open the main menu.
2. Select [9. ECHO SOUNDER SETTING].
3. Select [2. INT. REJ. SETTINGS].

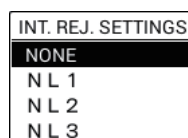

4. Select the level of interference reduction, [NL1], [NL2], or [NL3]. [NL3] provides the highest degree of interference reduction. [NONE] turns off the interference reduction.
5. Press the **DISP** key to close the menu.

11.8 How to Reduce Low Level Noise

Low intensity “spots” of noise appear over most of the screen like in the illustration shown below. These spots are caused by sediment in the water or noise. You can reduce this type of noise by adjusting CLUTTER on the menu.

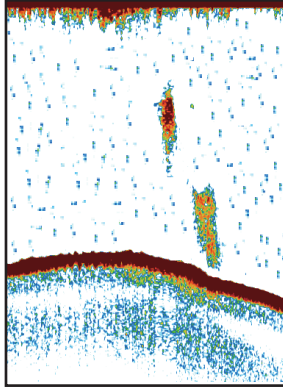

Note: This function is not available in the automatic mode.

1. Press the **MENU** key to open the main menu.
2. Select [9. ECHO SOUNDER SETTING].
3. Select [3. CLUTTER].

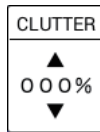

4. Set the clutter rejection level. The larger the setting value, the greater the degree of suppression. Set the level to “0%” when no clutter exists, to prevent erasure of weak echoes.
5. Press the **DISP** key to close the menu.

11.9 How to Erase Weak Echoes

Sediment in the water and reflections from plankton appear on the display in low-intensity colors. These weak echoes can be erased by using the [ERASING WEAK ECHOES] function. This function erases weaker echoes sequentially to show only strong echoes and clear up the picture.

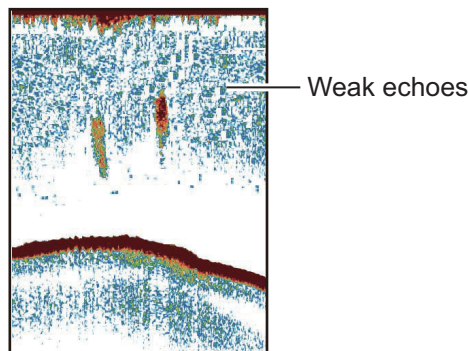

1. Press the **MENU** key to open the main menu.

2. Select [9. ECHO SOUNDER SETTING].
3. Select [4. ERASING WEAK ECHOES].

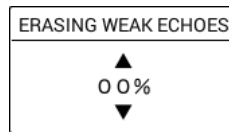

4. Set the color erasion level. The larger the setting value, the stronger the echo to erase. Set the level to "0%" to turn off the function for erasing weak echoes.
5. Press the **DISP** key to close the menu.

11.10 How to Highlight Echoes in White Color

11.10.1 White marker

The white marker displays the selected echo color in white. For example, you may want to display the bottom echo in white to discriminate fish echoes near the bottom.

1. Press the **MENU** key to open the main menu.
2. Select [9. ECHO SOUNDER SETTING].
3. Select [5. WHITE MARKER SETTING].

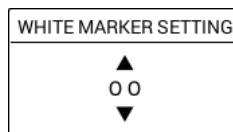

4. Select the color to display in white (setting range: 0 to 16, 0 is off). The color, corresponding to the selected echo number, of the color bar changes to white.

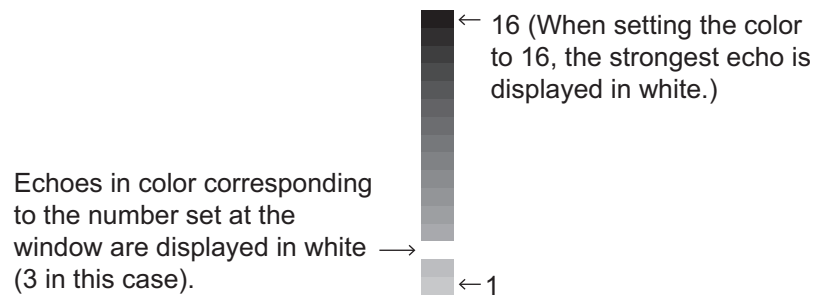

5. Press the **DISP** key to close the menu.

11.10.2 White line

The white line feature displays the leading edge of the bottom echo in white to help you distinguish bottom fish from the bottom echo.

1. Press the **MENU** key to open the main menu.
2. Select [9. ECHO SOUNDER SETTING].
3. Select [9. WHITE LINE].

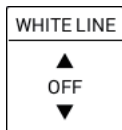

4. Set the width to display in white. The larger the setting value, the greater the width to display in white. [OFF] turns off the white line function. [WHITE EDGE] displays the contour of the bottom in white regardless of the gain setting or display color.
5. Press the **DISP** key to close the menu.

11.11 Display Colors

You can select the number of colors and background color to use as follows:

1. Press the **MENU** key to open the main menu.
2. Select [9. ECHO SOUNDER SETTING].
3. Select [6. HUE].



4. Select the hue number, referring to the table below. (You can see the result of your selection on the display.)

Hue no.	Echo color	Background color
0	Display color selected on the [DISPLAY COLOR SETTING] menu (See section 11.12.)	
1	64 colors	Blue
2	16 colors	Blue
3	64 colors	Dark blue
4	16 colors	Dark blue
5	64 colors	White
6	16 colors	White
7	64 colors	Black
8	16 colors	Black
9	Monochrome, 64 colors	

5. Press the **DISP** key to close the menu.

11.12 How to Customize Display Colors

In addition to the standard and factory programmed color sets, the user may set and store nine sets of display colors and recall them by setting [0] in the [HUE] window (see section 11.11).

1. Press the **MENU** key to open the main menu.
2. Select [9. ECHO SOUNDER SETTING].
3. Select [7. DISPLAY COLOR SETTING].

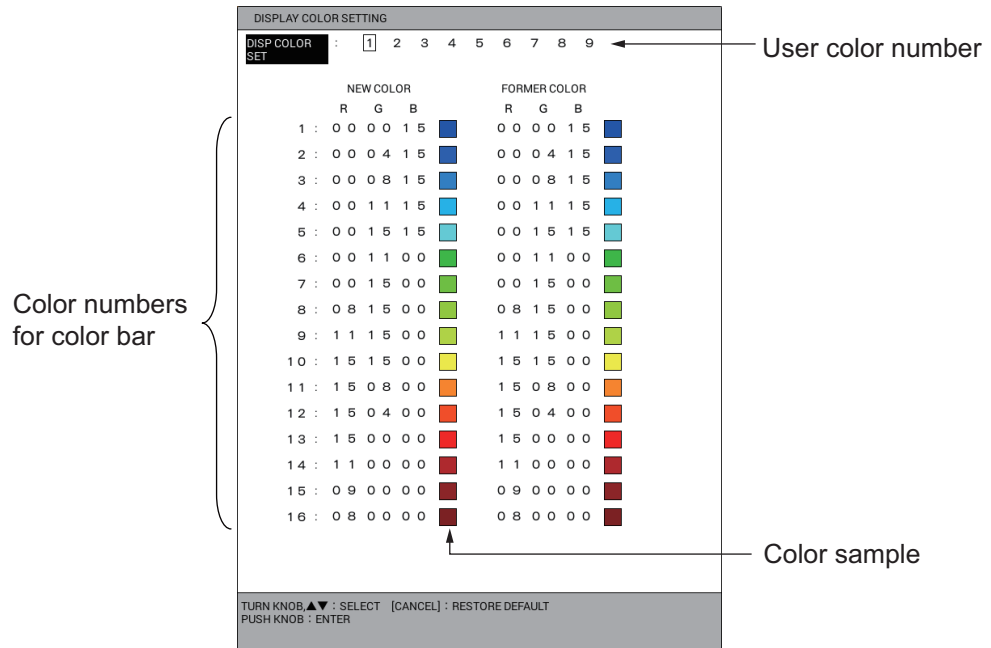

4. Select [DISP COLOR SET].
5. Select the user color number from 1 to 9.
6. Select the color number (1 to 16) to change.
7. Press the numeric keys to set the color brightness for [R] (red), [G] (green) or [B] (blue) of new color referring to the color samples (setting range: 0 to 15). The larger the number, the brighter the color.
8. Repeat step 6 and step 7 to set other colors.
9. Press the **DISP** key to close the menu.

How to restore the colors to the default setting

1. Press the **MENU** key to open the main menu.
2. Select [9. ECHO SOUNDER SETTING].
3. Select [7. DISPLAY COLOR SETTING].
4. Select [DISP COLOR SET].
5. Select the user color number to restore from 1 to 9.
6. Select the color number for the color to restore from 1 to 16 then press the **CANCEL** key.
7. Press the **DISP** key to close the menu.

11.13 Picture Advance Speed

The picture advance speed controls how quickly the vertical scan lines move across the screen. A fast advance speed expands the size of a school of fish horizontally on the screen. A slow advance speed shortens the school of fish. Use a fast advance speed to see the hard bottom. Use a slow advance speed to see the smooth bottom.

Note: When either the ACCU-FISH™ or Bottom Discrimination feature is active, the picture advance speed may be slowed.

 CAUTION



The picture is not refreshed when picture advancement is stopped.

Maneuvering the vessel in this condition can result in a dangerous situation.

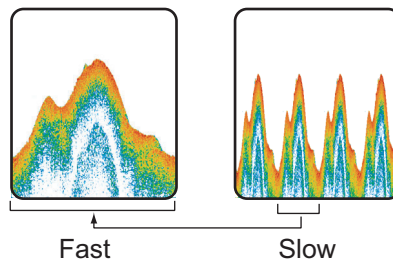

1. Press the **MENU** key to open the main menu.
2. Select [9. ECHO SOUNDER SETTING].
3. Select [8. PICTURE ADVANCE].
4. Select the picture advance speed. The options in the window indicate the number of scan lines made per transmission. For example, [2/1] creates two scan lines per one transmission and is the fastest advance speed. [1/16] creates one scan line per 16 transmissions and is the slowest advance speed. [STOP PICTURE ADVANCE] stops picture advance, and is useful for taking a photo or screenshot of the screen.
5. Press the **DISP** key to close the menu.

PICTURE ADVANCE
STOP PICTURE ADVANCE
1/16
1/8
1/4
1/2
1/1
2/1

11.14 How to Review Past Picture

One past picture can be taken and reviewed.

11.14.1 How to set up to display past picture

1. Press the **MENU** key to open the main menu.
2. Select [0. SYSTEM SETTING].
3. Select [8. ECHO SOUNDER INITIAL SETTING].

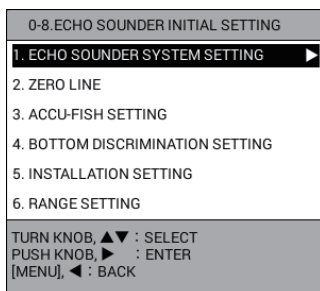

4. Select [1. ECHO SOUNDER SYSTEM SETTING].

5. Select [PLAYBACK SNDR IMAGE] on page 2.

ECHO SOUNDER SYSTEM SETTING		SEL. PAGE _ ◀2/2
COLOR BAR DISPLAY	: SHOW	HIDE
PLAYBACK SNDR IMAGE	: REPLAY FISH ECHO	
	SMALLER DISPLAY	OFF
SPEED CALIBRATION	: + 0 0 %	(-50 to +50)
TEMP CALIBRATION	: + 0 0 . 0	(-40.0 to +40.0)
DEPTH CALIBRATION	: + 0 0 0 . 0 f t	(-049.2 to +327.7)
SPEED OF SOUND SETTINGS	: SEA WATER (1500m/s)	
	PURE WATER (1470m/s)	
SEABED DETECTION POSITION	: 0 . 0 f t	
TURN KNOB, ▲▼ : SELECT PUSH KNOB : ENTER [0]~[9] : NO. OF PAGE ◀▶ : MOVE PAGE [MENU] : BACK		

6. Select [REPLAY FISH ECHO] or [SMALLER DISPLAY].
 [REPLAY FISH ECHO]: The past picture is played back reversely, like rewinding a video tape.
 [SMALLER DISPLAY]: The past picture is compressed to show it in its entirety.
 [OFF]: The past picture is not reviewed.
7. Press the **DISP** key to close the menu.

11.14.2 How to review past picture

- Push the **ENTER** knob. The picture freezes, and "PLAY" appears at the top right of the screen. The picture is then shown according to the replay method set on the menu (see subsection 11.14.1).
 [REPLAY FISH ECHO]: Rotate the **ENTER** knob counterclockwise to scroll the past picture, clockwise to scroll back to the current picture.
 [SMALLER DISPLAY]: The compressed entire past picture appears.
- Push the **ENTER** knob to ease the past picture and return to normal operation. The "PLAY" indication disappears from the screen.

Note: A mark entered in the replay mode is marked on the normal plotter display. To enter a mark, press a numeric key (1 to 8). The corresponding mark or number is entered on the ship's track appropriate to the time marker when the cursor is turned on, or at the own ship position when the cursor is turned off. When switching the display from the plotter to the echo sounder, the normal echo sounder display appears. To enter a waypoint, press the **WPT** key. The waypoint is entered at the same position as a mark depending on cursor on/off. For the time marker, see section 11.5.

11.15 ACCU-FISH™

The ACCU-FISH™ feature, which requires an ACCU-FISH™ capable transducer, calculates the length of each fish and shows a fish symbol and depth value or fish length.

Usage guidelines

- This feature requires an ACCU-FISH™ capable transducer. For details, see “EQUIPMENT LIST” in the installation manual.
- This feature is intended for reference purposes; it is not a completely accurate measurement of fish length.
- The intensity of an echo depends on fish species. If the indicated length is different from the true length, you can apply an offset on the menu (see section 11.15.2).
- Fish at depths of less than two meters cannot be measured. However, if [ZERO LINE REJECTION] is set to [ON], fish within the area covered by the transmission line cannot be detected (see section 11.19).
- This feature cannot be used with the transducer installed inside the hull. Depending on the transducer frequency, fish may not be detected. Further, even if fish are detected, their indicated length may be smaller than the actual length.
- In a school of fish, the echoes overlap. This causes a greater margin of error in fish size measurement.
- The TX pulse length changes according to ACCU-FISH™ On/Off state. This causes a difference in both sensitivity and the echoes viewed.





11.15.1 How to set up ACCU-FISH™

1. Press the **MENU** key to open the main menu.
2. Select [0. SYSTEM SETTING].
3. Select [8. ECHO SOUNDER INITIAL SETTING].
4. Select [3. ACCU-FISH SETTING].

ACCU-FISH SETTING			
FISH INFORMATION	: FISH SIZE	WATER DEPTH	[OFF]
DISPLAY SIZE	: [SMALL]	LARGE	
FISH MARK	: MARK1	[MARK2]	○
	□	OFF	
FISH SIZE CALIB.	: + 0 0 0 %		
FISH DISPLAY SETTING	: 50kHz	200kHz	50/200kHz
	MIXED	[ALL]	HIDE
FISH LENGTH UNIT	: cm	[inch]	
TURN KNOB, ▲▼ : SELECT PUSH KNOB : ENTER			
[MENU] : BACK			

5. Select [FISH INFORMATION].
6. Select [FISH SIZE], [WATER DEPTH] or [OFF].
 [FISH SIZE]: Shows fish size.
 [WATER DEPTH]: Shows depth to the fish.
 [OFF]: Turns off ACCU-FISH™.
7. Select [DISPLAY SIZE].
8. Select the text size for fish information from [SMALL] or [LARGE].

9. Select [FISH MARK].
10. Select the fish mark symbol to show. The size of the symbol including and changes with the size of the fish.

Fish size	MARK1	MARK2
Large fish symbol (more than 50 cm (20 inches))		
Small fish symbol (10 to 49 cm (4 to 19 inches))		

11. Press the **DISP** key to close the menu.

11.15.2 How to correct measured fish size

The fish size shown on the screen can be different from the true size. If the size is wrong, add an offset to the measured value to get a more accurate indication on the screen.

1. Press the **MENU** key to open the main menu.
2. Select [0. SYSTEM SETTING].
3. Select [8. ECHO SOUNDER INITIAL SETTING].
4. Select [3. ACCU-FISH SETTING].
5. Select [FISH SIZE CALIB.].
6. Press the numeric keys to set the correction percentage, referring to the table below (setting range: -80 to +100%).

Setting	Revised size
+100%	Two times
+50%	1.5 times
-50%	1/2
-80%	1/5

7. Press the **DISP** key to close the menu.

11.15.3 How to select the display mode to show fish information

1. Press the **MENU** key to open the main menu.
2. Select [0. SYSTEM SETTING].
3. Select [8. ECHO SOUNDER INITIAL SETTING].
4. Select [3. ACCU-FISH SETTING].
5. Select [FISH DISPLAY SETTING].
6. Select the display mode to show fish information.
 - [50kHz]: Shows fish information only on the 50 kHz display.
 - [200kHz]: Shows fish information only on the 200 kHz display.
 - [50/200kHz]: Shows fish information on the 50 kHz and 200 kHz displays.
 - [MIXED]: Shows fish information only on the mixed display.
 - [ALL]: Shows fish information on all displays.
 - [HIDE]: Does not show fish information on all displays.
7. Press the **DISP** key to close the menu.

11.15.4 How to select the unit for fish length

1. Press the **MENU** key to open the main menu.
2. Select [0. SYSTEM SETTING].
3. Select [8. ECHO SOUNDER INITIAL SETTING].
4. Select [3. ACCU-FISH SETTING].
5. Select [FISH LENGTH UNIT].
6. Select [cm] or [inch].
7. Press the **DISP** key to close the menu.

11.16 Bottom Discrimination Display

The bottom discrimination (seabed composition) display analyzes the bottom echo to categorize bottom hardness in one of four types (rocks, gravel, sand, mud) and shows the results in a colorful graphic display. A transducer or triducer that supports the bottom discrimination display is required. There are two bottom discrimination displays: [GRAPHIC] and [DETAILS].

[GRAPHIC]: The most probable material on the bottom is indicated.

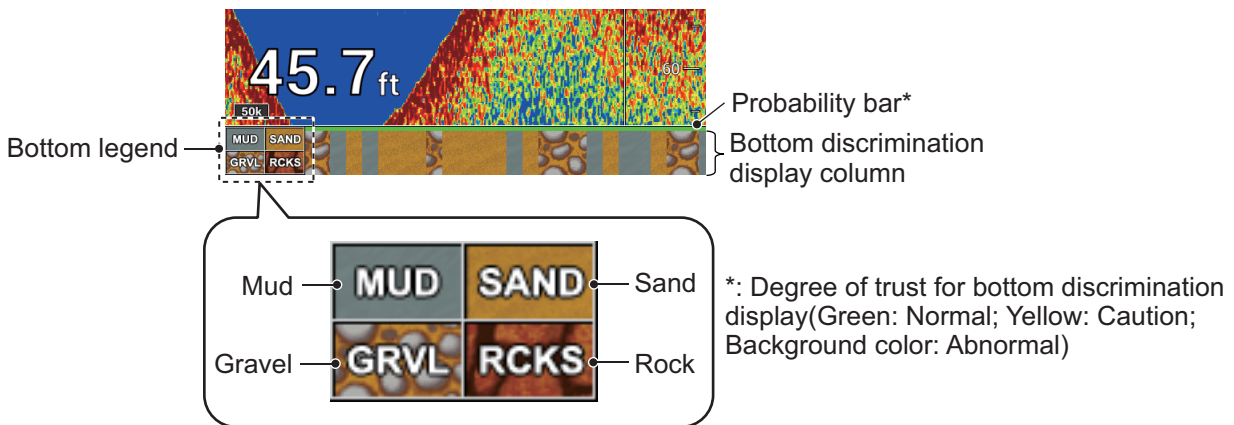

[DETAILS]: The probability of the bottom material is graphically indicated in proportion.

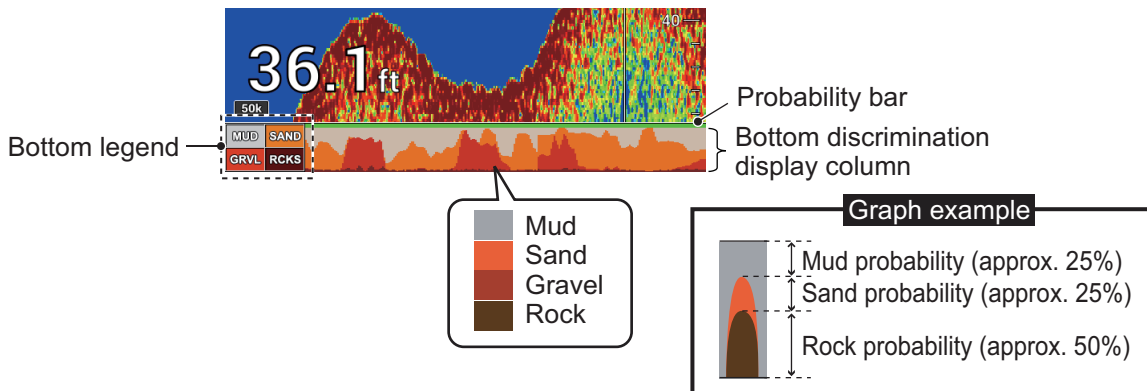

Usage guidelines

- The bottom discrimination display provides an estimate of seabed composition. Actual composition may be different.
- This feature requires a bottom discrimination capable transducer. For details, see “EQUIPMENT LIST” in the installation manual.
- The high and low frequencies are alternately transmitted, regardless of current display selection. The TX interval is slower when this feature is active.
- Use this feature at 5 to 100 m of depth, 10 knots or less of speed.
- This feature uses the range from the ship’s draft; therefore, enter the ship’s draft.

How to set up bottom discrimination display

Note: Automatic range is automatically turned on when the bottom discrimination display is activated.

1. Press the **MENU** key to open the main menu.
2. Select [0. SYSTEM SETTING].
3. Select [8. ECHO SOUNDER INITIAL SETTING].
4. Select [4. BOTTOM DISCRIMINATION SETTING].

BOTTOM DISCRIMINATION SETTING			
SEABED COMPOSITION	: GRAPHIC	DETAILS	[OFF]
BOTTOM LEGEND	: SHOW	[HIDE]	
TURN KNOB, ▲▼ : SELECT PUSH KNOB : ENTER			
[MENU] : BACK			

5. Select [SEABED COMPOSITION].
6. Select [GRAPHIC], [DETAILS] or [OFF].
 [GRAPHIC]: Displays the most probable material on the bottom.
 [DETAILS]: Graphically displays the probability of the bottom material in proportion.
 [OFF]: Turns off the bottom discrimination feature.
7. Select [BOTTOM LEGEND].
8. Select [SHOW] or [HIDE].
9. Press the **DISP** key to close the menu.

11.17 Alarms

The echo sounder has four alarms: fish alarm (normal), fish alarm (bottom lock), fish alarm (fish size) and bottom discrimination alarm. When the conditions of an alarm are violated, the alarm icon and alarm name appear at the bottom left of the display* and the audio alarm sounds. You can silence the audio alarm by pressing the **CANCEL** key. The alarm icon remains on the screen until the cause of the alarm is cleared or the alarm is deactivated. When the conditions of an alarm are violated again, the alarm icon appears and the audio alarm sounds.

For audio alarm type, see section 8.1.

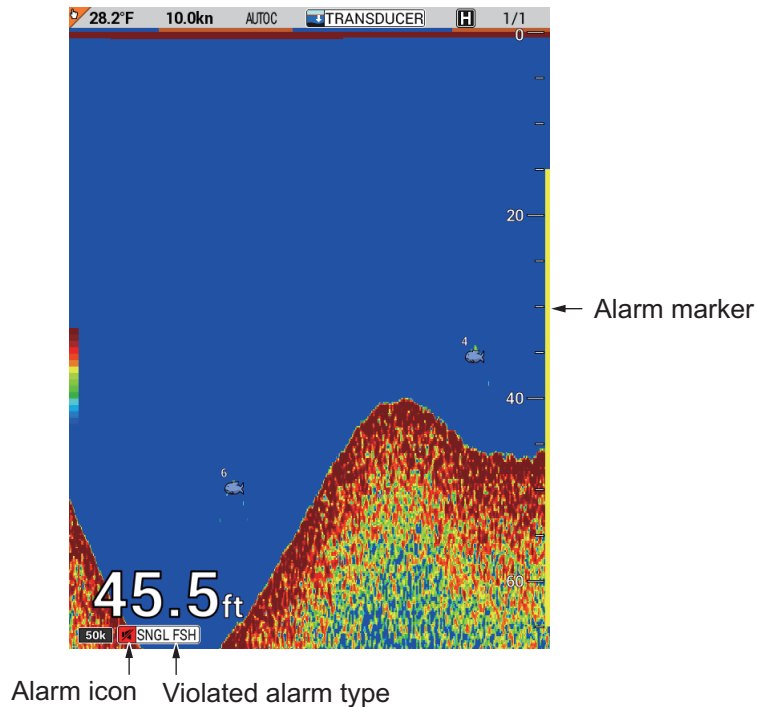

Note 1: When multiple alarms occur, violated alarm types alternately appear at the bottom of the display.

Note 2: *: The fish alarm (bottom lock) is available only on the bottom lock display. The alarm icon and alarm name appear at the bottom of the right single display.

11.17.1 Fish alarm (normal)

The fish alarm (normal) sounds when a fish echo is within the preset alarm range, thus the fish alarm can alert you when fish echoes are within a certain depth range. Note that the sensitivity of the fish alarm can be set on the [FISH ALARM LEVEL] menu of the [ECHO SOUNDER SYSTEM SETTING] menu. For details, see section 11.18.

1. Press the **MENU** key to open the main menu.
2. Select [6. ALARM SETTINGS].

3. Select [FISH ALARM (NORMAL)] on page 3.

ALARM SETTINGS		SEL. PAGE _ ◀3/4▶
SHEAR ALARM	: ON	[OFF]
VARIATION RANGE	: 0 0 . 1	(0.1 to 10.0)
DETECTION INTERVAL	: 0 1 0 S.	(10 to 120)
DEPTH ALARM	: ON	[OFF]
STARTING DEPTH	: 0 0 0 0 . 0 m	
WIDTH	: 0 0 0 0 . 0 m	
FISH ALARM (NORMAL)	: ON	[OFF]
STARTING DEPTH	: 0 0 0 0 . 0 m	
WIDTH	: 0 0 0 0 . 0 m	
FISH ALM (BTM LOCK)	: ON	[OFF]
STARTING DEPTH	: 0 0 . 0 m	
WIDTH	: 0 0 . 0 m	
FISH ALARM	: ON	[OFF]
FISH SIZE	: 0 1 0 . 0 c m	

TURN KNOB, ▲▼ : SELECT PUSH KNOB : ENTER
 [0]~[9] : NO. OF PAGE ◀▶ : MOVE PAGE
 [MENU] : BACK

4. Select [ON].
 5. Select [STARTING DEPTH].
 6. Press the numeric keys to enter the starting depth. The starting depth is the distance from the transducer.
 7. Select [WIDTH].
 8. Press the numeric keys to enter the alarm range.
 9. Press the **DISP** key to close the menu.
The alarm marker (yellow) appears at the right side of the screen.
- To disable the alarm, select [OFF] at step 4.

11.17.2 Fish alarm (bottom lock)

The fish alarm (bottom lock) sounds when a fish echo is within a predetermined distance from the bottom, which makes it useful for detecting fish close to the bottom. This alarm is available for the bottom lock display. Note that the sensitivity of the fish alarm can be set on the [FISH ALARM LEVEL] menu of the [ECHO SOUNDER SYSTEM SETTING] menu. For details, see section 11.18.

1. Press the **MENU** key to open the main menu.
2. Select [6. ALARM SETTINGS].
3. Select [FISH ALM (BTM LOCK)] on page 3.
4. Select [ON].
5. Select [STARTING DEPTH].
6. Press the numeric keys to enter the starting depth. The starting depth is the distance from the bottom.
7. Select [WIDTH].
8. Press the numeric keys to enter the alarm range.
9. Press the **DISP** key to close the menu.

The alarm marker (yellow) appears at the left side of the bottom lock or bottom discrimination display.

To disable the alarm, select [OFF] at step 4.

11.17.3 Fish alarm (fish size)

The fish alarm (fish size) sounds when a fish of the specified length appears. This alarm is available when the [FISH INFORMATION] menu of the [ACCU-FISH SETTING] is set to [FISH SIZE].

1. Press the **MENU** key to open the main menu.
2. Select [6. ALARM SETTINGS].
3. Select [FISH ALARM] on page 3.
4. Select [ON].
5. Select [FISH SIZE].
6. Press the numeric keys to enter the fish size.
7. Press the **DISP** key to close the menu.

To disable the alarm, select [OFF] at step 4.

11.17.4 Bottom discrimination alarm

The bottom discrimination (seabed composition) alarm sounds when the bottom type (rock, gravel, sand, mud) matches both the bottom type and probability percentage selected. This alarm is available when the [SEABED COMPOSITION] menu of the [BOTTOM DISCRIMINATION SETTING] is set to [GRAPHIC] or [DETAILS].

1. Press the **MENU** key to open the main menu.
2. Select [6. ALARM SETTINGS].
3. Select [BOTTOM DISC. ALARM] on page 4.
4. Select [ON].
5. Select [SEABED TYPE TO DETECT].
6. Select bottom type to detect from [ROCK], [GRAVEL], [SAND] or [MUD].
7. Select [DETECTION ACCURACY].
8. Select detection probability percentage for the bottom selected at step 6 (setting range: 50 to 90%).
9. Press the **DISP** key to close the menu.

To disable the alarm, select [OFF] at step 4.

11.18 [ECHO SOUNDER SYSTEM SETTING] Menu

The [ECHO SOUNDER SYSTEM SETTING] menu sets up the functions of the echo sounder display.

1. Press the **MENU** key to open the main menu.
2. Select [0. SYSTEM SETTING].
3. Select [8. ECHO SOUNDER INITIAL SETTING].
4. Select [1. ECHO SOUNDER SYSTEM SETTING].

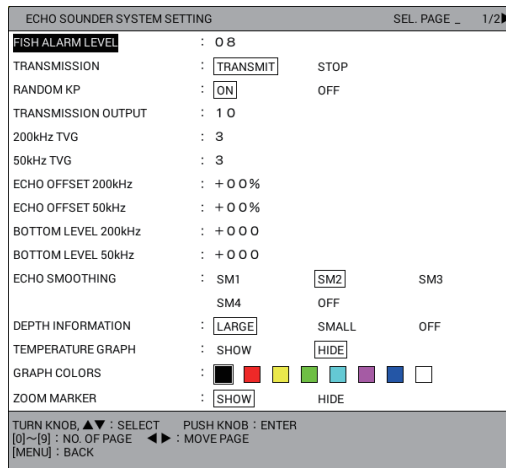

Page 1

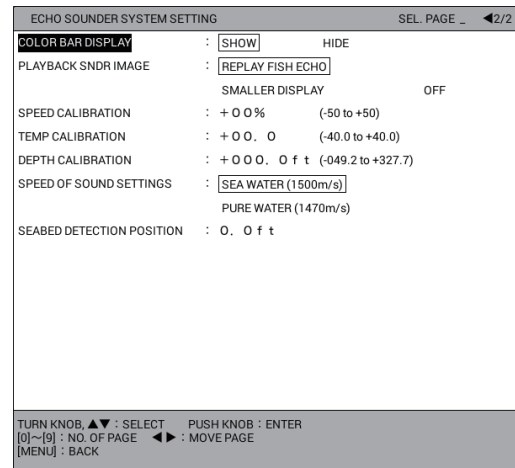

Page 2

5. Set each menu item referring to the following.
 - [FISH ALARM LEVEL]: Set the echo strength that triggers the fish alarms (setting range: 1 to 15, default: 8). Set the smaller value for ice-blue and stronger echoes, medium value for yellow and stronger echoes, larger value for red and stronger echoes.
 - [TRANSMISSION]: Turns TX power on or off. [TRANSMIT] enables transmission. [STOP] stops transmission.
 - [RANDOM KP]: To reduce interference caused by the pulse transmission of own fish finder, correct the cycle of pulse transmission randomly. Select [ON] to activate this function.
 - [TRANSMISSION OUTPUT]: When two or more fish finders are being operated in the same vicinity, mutual interference can occur. To reduce the interference, you can reduce the transmission power by lowering this setting. To disable this fish finder, set this setting to [0] (setting range: 0 to 10, default: 10).
 - [200kHz TVG], [50kHz TVG]: TVG (Time Varied Gain) compensates for propagation attenuation of the ultrasonic waves. It does this by equalizing echo presentation so that schools of fish of the same size appear in the same density in both shallow and deep waters. In addition, it reduces surface noise. Note that if the TVG level is set too high short range echoes may not be displayed (setting range: 0 to 9, default: 3).
 - [ECHO OFFSET 200kHz], [ECHO OFFSET 50kHz]: If the on-screen echo level appears to be too weak or too strong and the level cannot be adjusted satisfactorily with the gain control on the display unit, adjust echo offset to compensate for too weak or too strong echoes (setting range: -50 to +50%).
 - [BOTTOM LEVEL 200kHz], [BOTTOM LEVEL 50 kHz]: If the depth indication is unstable in automatic operation or the bottom echo cannot be displayed in reddish-brown by adjusting the gain control in manual operation, you may adjust the bottom echo level detection circuit, for both 50 kHz and 200 kHz, to stabilize the

indication. Proper adjustment is important. If the level is too low, weak echoes may be recognized as the bottom echo. If the level is too high, the depth indication is not displayed (setting range: -200 to +100).

[ECHO SMOOTHING]: Smooths echoes to present a stable display (options: [SM1], [SM2], [SM3], [SM4], [OFF], default: [SM2]). The higher the setting the greater the smoothing.

[DEPTH INFORMATION]: Selects the size of the depth indication at the bottom left of the screen, [LARGE] (default), [SMALL], or [OFF] (no indication).

[TEMPERATURE GRAPH]: Turns the temperature graph on or off. [GRAPH COLORS] sets the color of the graph from black (default), red, yellow, green, light-blue, purple, blue or white.

[ZOOM MARKER]: Turns the zoom marker on or off on the single frequency display for the bottom lock, bottom zoom or marker zoom display.



[COLOR BAR DISPLAY]: Turns the color bar on or off. The color bar shows the relation between echo intensity and echo color on the screen. The top color (red-dish-brown) is the strongest color and the lower colors the weakest. The bar can be used as a reference to estimate density of a school of fish, fish species and hardness of the bottom. The background color can be selected on the [HUE] menu of the [ECHO SOUNDER SETTINGS] menu (see section 11.11).

[PLAYBACK SNDR IMAGE]: Reviews the past picture. For details, see section 11.14.

[SPEED CALIBRATION]: Applies an offset to the speed data. See the installation manual.

[TEMP CALIBRATION]: Applies an offset to the water temperature data. See the installation manual.

[DEPTH CALIBRATION]: In the default arrangement, the depth is measured from the transducer. If you would rather measure depth from the sea surface or keel, enter the vessel's draft. The indication of the sound reference (see page 11-2) changes depending on the setting value. See the examples in the table below.

	The depth is the distance from the sea surface when the setting value (offset) is plus.
	The depth is the distance from the transducer when the setting value is 0.
	The depth is the distance from the keel when the setting value (offset) is minus.

[SPEED OF SOUND SETTINGS]: Selects speed of sound from [SEA WATER(1500m/s)] (default) or [PURE WATER(1470m/s)].

[SEABED DETECTION POSITION]: When the zero line (transmission line) is detected as the bottom, set this value deeper than the position of zero line end.

6. Press the **DISP** key to close the menu.

11.19 Zero Line Rejection

The zero line (transmission line) shows the position of the transducer and its signal strength is the strongest. When turning the zero line rejection on, the transmission line disappears, which allows you to see fish echoes near the surface clearly. The length of the transmission line changes with transducer used and installation characteristics. If the width of the transmission line is 4.5 ft or more, set the transmission line width with [Z.L. REJECT RANGE].

1. Press the **MENU** key to open the main menu.
2. Select [0. SYSTEM SETTING].
3. Select [8. ECHO SOUNDER INITIAL SETTING].
4. Select [2. ZERO LINE].

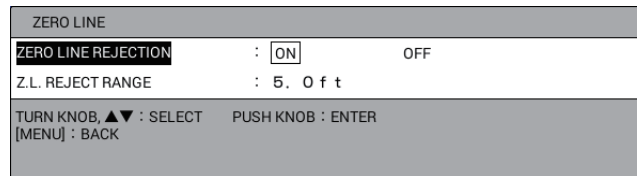

5. Select [ZERO LINE REJECTION].
6. Select [ON] to turn this function on, [OFF] to turn off.
7. Select [Z.L.REJECT RANGE].
8. Press the numeric keys to set the transmission line width (setting range: 3.3 ft to 9.5 ft). For a long tail, increase the value. If the transmission line does not disappear, lower the TX power.
9. Press the **DISP** key to close the menu.

11.20 Echo Sounder Range Setting Menu

This section shows you how to set custom ranges for basic range (section 11.4.2), zoom range (marker and bottom zoom, section 11.2.3 and section 11.2.4) and bottom lock range (section 11.2.5).

Note: All basis ranges (1 to 8), zoom range, and bottom lock range are restored whenever the unit of depth measurement is changed. Therefore, change the depth unit before changing the ranges.

1. Press the **MENU** key to open the main menu.
2. Select [0. SYSTEM SETTING].
3. Select [8. ECHO SOUNDER INITIAL SETTING].
4. Select [6. RANGE SETTING].

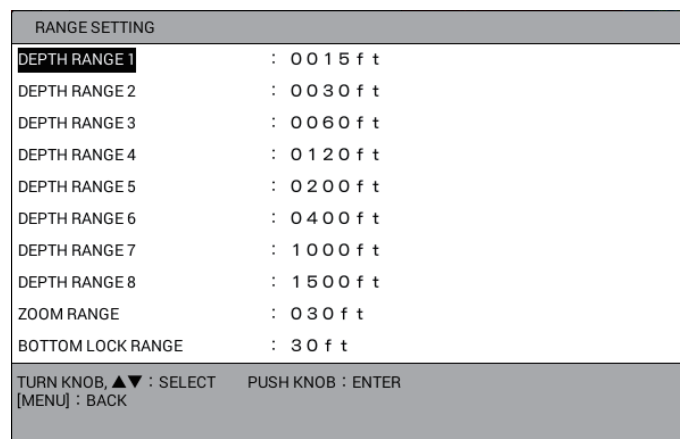

5. Select the item to change.
6. Press the numeric keys to set the range.

Note: For basic range, set depth from lowest to highest. A range cannot be higher than its succeeding neighbor.
7. Press the **DISP** key to close the menu.

11.21 Interpreting the Display

This section provides, using typical examples, the information necessary for interpreting the echo sounder display.

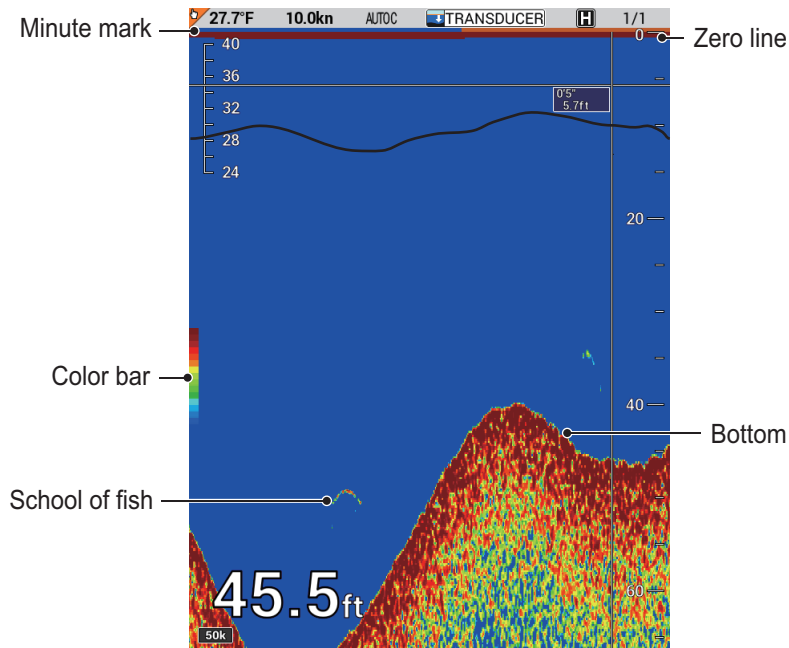

Color bar

The color bar shows the relation between echo intensity and echo color on the screen. The top color (reddish-brown) is the strongest color and the lower colors the weakest. The bar can be used as a reference to estimate density of a school of fish, fish species and hardness of the bottom. The background color can be selected on the menu (see section 11.11).

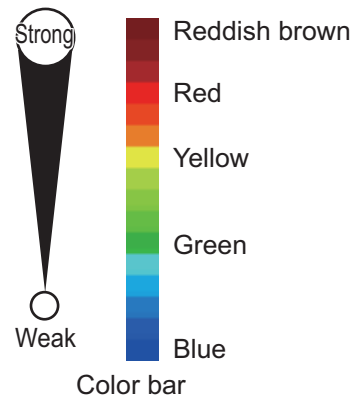

Minute mark

The minute mark displays a minute worth of time with two colored bars, each bar 30 seconds in time. It is useful for estimating elapsed time.

Zero line

The zero line (transmission line) shows the position of the transducer. The line disappears from the screen when the range is shifted.

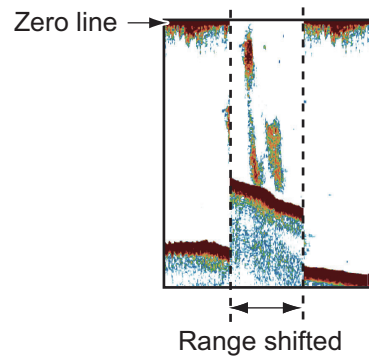

Bottom echoes

The strongest echoes are from the bottom, and are normally shown in reddish-brown or red. The colors and the width change with bottom material, depth, sea condition, installation, frequency, pulse length and sensitivity.

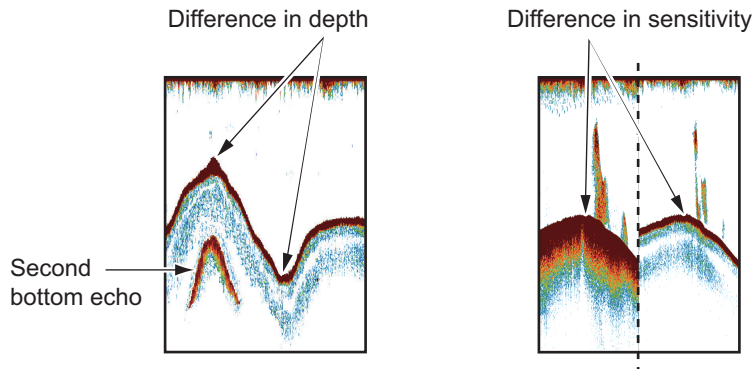

Bottom contour

The tail from a hard bottom is longer than the tail from a soft bottom, because the hard bottom reflects more of the ultrasonic pulse. An echo from shallow water gives a stronger reflection than the echo received from deep water. A longer bottom tail appears on slopes, because of the difference in travel time at both edges of the beam angle. For the rough bottom, echoes are reflected on many different planes, which displays echoes in many layers, giving a 3D effect.

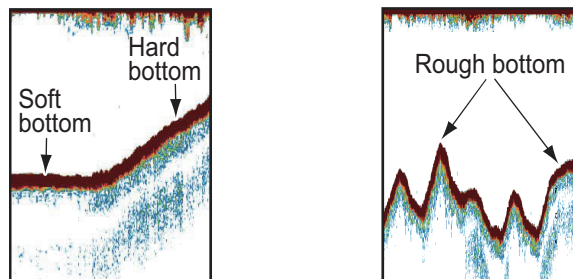

Nature of a bottom

The nature of a bottom is known from the intensity and length of the bottom tail. To find the nature of a bottom, use a long pulse length and normal gain. For the hard and rough bottom, the bottom echo is reddish-brown with a long tail. For the mud or sand bottom, the bottom echo has less red and with a short tail. A bottom with a lot of small particles can give a long tail on the low frequency picture.

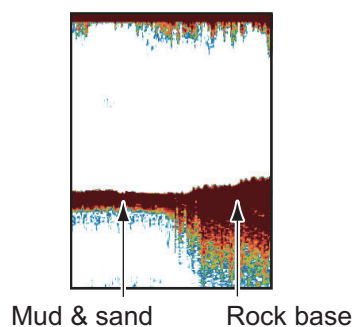

Echoes from school of fish

Fish volume

The size and density of a school of fish are indicators of the quantity of fish.

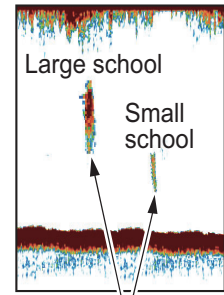

Size of school of fish

Size of school of fish

Usually the size of fish echoes on the screen is proportional to the actual size of the school of fish. However, if two fish echoes appear at different depths with the same size, the school of fish at the shallower depth is larger because the ultrasonic beam widens as it propagates and a school of fish in deep water is displayed larger.

School depth and sounding time

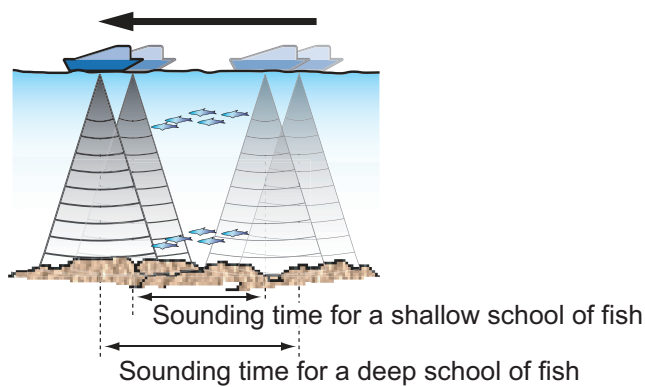

Density of school of fish

If two schools appear with the same color at different depths, the one in deeper water is denser because the ultrasonic wave attenuates as it propagates and the school of fish in deep water tends to be displayed in a weaker color.

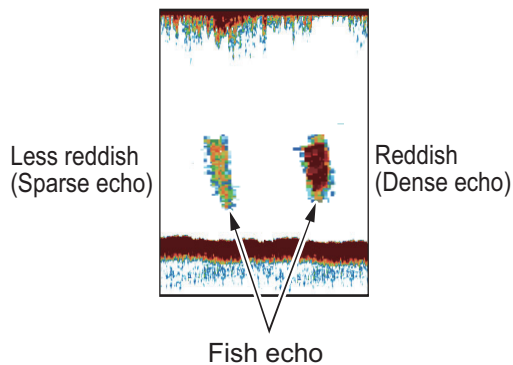

Difference in signal strength

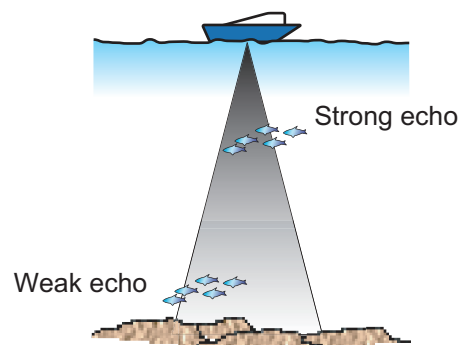

Bottom fish

The echoes from the bottom are stronger than the bottom fish echoes so that you can distinguish between them by colors. The bottom echoes are normally shown in reddish-brown or red, the bottom fish echoes in weaker color.

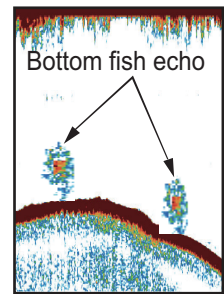

Plankton, current rip

Plankton

A plankton layer appears as a large amount of green or blue dots, and is a possible location for fish. A plankton layer moves down in the day and up at night.

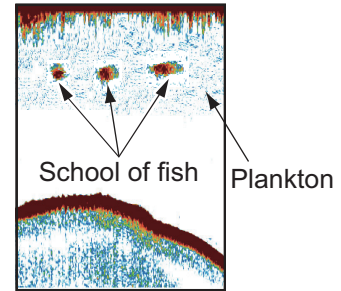

Current rip

When two ocean currents of different speeds directions and water temperatures meet, a current rip occurs. A current rip appears on the screen as shown in the right illustration.

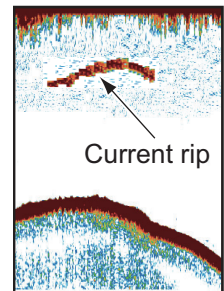

Surface noise

When the sea is rough or the ship moves over a wake, surface noise can appear at the top of the screen. It can be suppressed with the clutter function (see section 11.8).

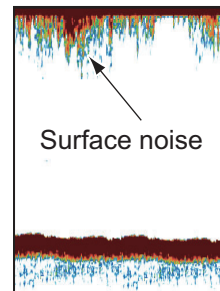

Air bubbles in the water

When the sea is rough or the ship makes a quick turn, there can be blank spots in the bottom echo (see the right illustration). These blank spots are caused by air bubbles which stop the movement of the sound wave. These air bubbles can occur with the low frequency ultrasonic waves.

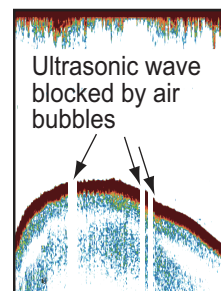

Unstable bottom echo

The bottom echoes can have a saw-tooth appearance. This occurs in heavy weather because pitching and rolling changes the direction of the ultrasonic pulses and the vertical motion of the ship causes the distance to the bottom to change.

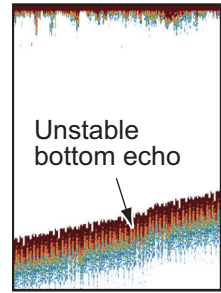

False echo

When an ultrasonic pulse is transmitted, some energy leaves from each side of the beam. This energy has the name "sidelobe". Echoes from sidelobes show on the screen as false images like in the illustration shown below.

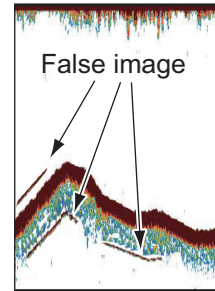
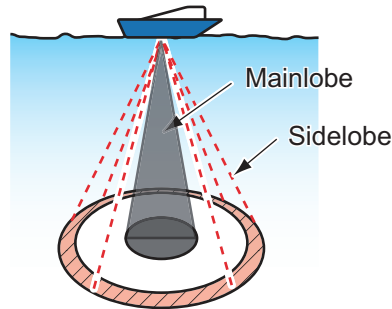

Interference. noise

As shown in the figure below, unwanted signals are displayed cyclically or at random. The source of these unwanted signals may be induction from electrical machinery, ship's vibration, engine noise, interference from other sounders being operated nearby, etc. As a general rule, echoes from interference usually appear below the bottom echo. If TVG is ON, echoes and interference will become stronger as the depth becomes deeper. If interference is present on the screen, lower the TX frequency or turn on the interference reduction (see section 11.7).

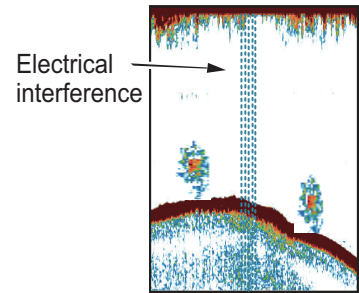
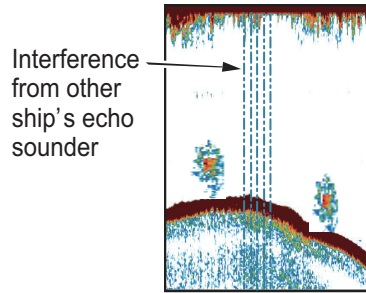
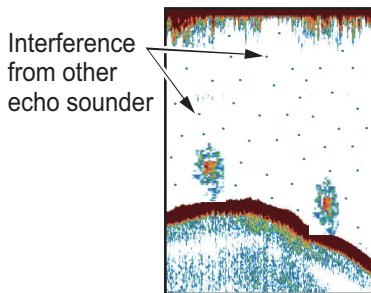









12. AIS OPERATIONS

With connection of an AIS transponder, up to 100 AIS targets (ship's name, position, navigation data) can be shown on the plotter display. The AIS operation requires WGS-84 geodetic datum.

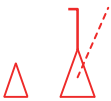
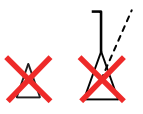
Note: Set the datum for the port connected an AIS transponder to WGS-84 (section 9.6.1). It is dangerous to select the other datum because the position of an AIS target can not be displayed correctly.

12.1 AIS Symbols

AIS targets are marked with the appropriate AIS symbol, as shown in the table below.

Symbol	Status	Remarks
	Sleeping target	Denote sleeping AIS symbol. (Triangle is smaller than activated AIS symbol.)
	Activated target	Denote activated AIS symbol, with heading line and vector for course and speed.
	Turning target	Denote activated AIS symbol making a turn.
	Dangerous target	Target's CPA and TCPA are within the CPA and TCPA settings. Displayed in red.
	Lost target	Red "X" overlaid on an AIS symbol and is flashing.
	Physical (real) ATON (AIS aid to navigation)	
	Virtual ATON (AIS aid to navigation)	
	AIS base station	
	AIS aircraft	Lost time: 50 seconds
	AIS search and rescue transmitter (SART)	Lost time: 10 minutes

Note: AIS symbols are momentarily erased and the screen is redrawn after the heading is changed in the head up mode.

How to show AIS symbols

1. Press the **MENU** key to open the main menu.
2. Select [4. MARK/TRACK SETTING].

12. AIS OPERATIONS

- Go to page 4, then select [DISPLAY AIS SYMBOLS].

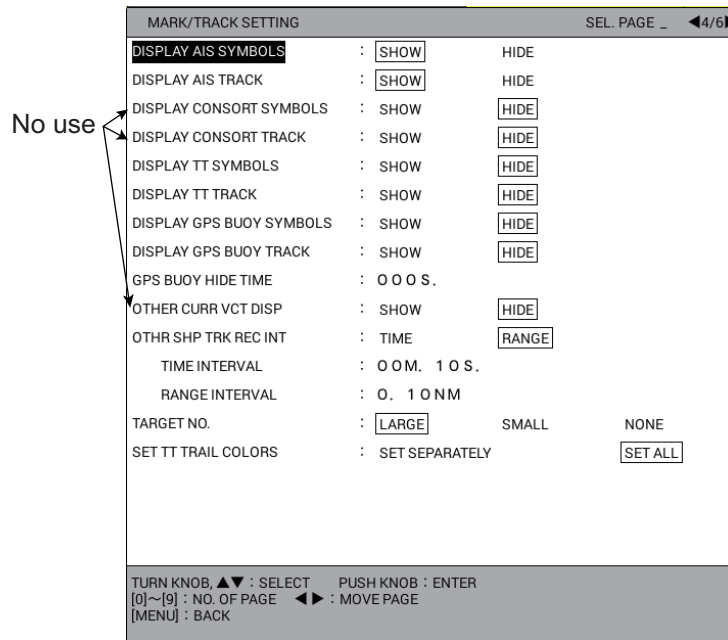

- Select [SHOW] to show the AIS symbols, [HIDE] to hide the AIS symbols.
- Press the **DISP** key to close the menu.

12.2 How to Activate/Sleep Targets

When you convert a sleeping target to an activated target, an activated target's course and speed are shown with a vector. You can easily judge target movement by monitoring the vector.

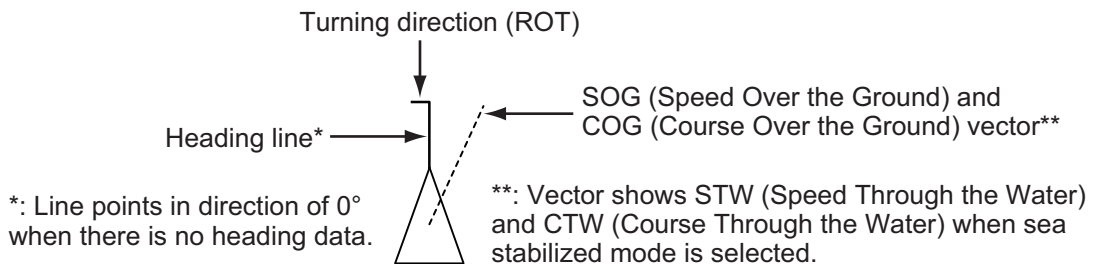

You can “sleep” an AIS target when the screen becomes filled with targets, which might prevent important radar and AIS displays from being identified. Dangerous targets cannot be “slept”. To activate or sleep targets, do the following:

- Press the **CURSOR ON/OFF** key to turn on the cursor.
- Put the cursor on the target you wish to activate or sleep then push the **ENTER** knob to show the AIS detail data (see section 12.4.1).
- Push the **ENTER** knob. Each push of the knob activates or sleeps the selected target alternately.
- Press the **MENU** or **DISP** key to close the information window.

12.3 AIS Tracks

12.3.1 How to show/hide AIS tracks

1. Press the **MENU** key to open the main menu.
2. Select [4. MARK/TRACK SETTING].
3. Select [DISPLAY AIS TRACK] on page 4.
4. Select [SHOW] to show the AIS tracks, [HIDE] to hide the AIS tracks.
5. Press the **DISP** key to close the menu.

12.3.2 How to change the AIS symbol/track color or track line type

1. Press the **CURSOR ON/OFF** key to turn on the cursor.
2. Put the cursor on an AIS symbol then press the **TRACK COLOR** key to display the [CHANGE TRACK COLOR (ALL AIS)] window.

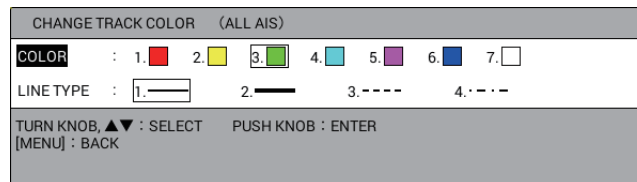

Note: This window automatically closes when there is no operation for 10 seconds.

3. Select [COLOR].
4. Select the color for the AIS symbol/track. All AIS symbols and tracks are displayed in the selected color from now.
5. Select [LINE TYPE].
6. Select the line type for the AIS track. AIS tracks are displayed with the selected line type from now.
7. Press the **MENU** or **DISP** key to close the window.

Note: The AIS symbol/track color or track line type can be changed on the AIS list (see section 12.4.2).

12.3.3 How to stop/restart recording of AIS track

You can stop recording the AIS track as follows.

1. Press the **CURSOR ON/OFF** key to turn on the cursor.
2. Put the cursor on the AIS symbol to stop recording then press the **PLOT INTVL** key. The track for the selected AIS symbol is not recorded during stopping recording.
3. To restart recording, put the cursor on the AIS symbol to restart recording then press the **PLOT INTVL** key.

Note: You can stop or restart recording of AIS track from the AIS list (see section 12.4.2).

12.4 AIS Target Data

You can display the AIS target data.

12.4.1 How to display the individual AIS target data

Basic AIS target data

1. Press the **CURSOR ON/OFF** key to turn on the cursor.
2. Put the cursor on the target you wish to display its data to show the basic AIS target data.

```
MMSI : 123456700
NAME OF SHIP : Ship_AIS_1
COURSE : 107.4°M   SHIP SPEED : 10.0kn
APPR RNG : 1.783NM   APPR TME : 34m10s
BEARING : 103.4°M   DISTANCE : 1.784NM
SHIP WIDTH : -m   SHIP LENGTH : -m
```

“- -” is displayed for the item without data.

Detailed AIS target data

1. Press the **CURSOR ON/OFF** key to turn on the cursor.
2. Put the cursor on the target you wish to display its data then push the **ENTER** knob to show the detailed AIS target data.

```
AIS DETAIL INFO
SHIPNAME      : Ship_AIS_1
CALL SIGN     : -
MMSI NUMBER   : 123456700
COURSE        : 107.4°M      SOG          : 10.0kn
APPR TME      : 34m10s      APPR RNG    : 1.783NM
RANGE         : 1.783NM      BRG         : 103.3°M
WAYPOINT      : -
SHIP TYP      : not available
SHP COND      : Under way sailing
ELAPSED       : 1s
HDG BRG       : 107.4°M      ROT         : +0.0°/min
OS LEN.       : -m          OS WID.     : -m
DANGER        : -
POSITION      : 34° 43.4040'N, 135° 24.3630'E
PUSH KNOB : ACT./DEACT.
[MENU] : CLOSE
```

“- -” is displayed for the item without data.

3. Press the **MENU** or **DISP** key to close the window.

Note 1: You can display the detailed AIS target data from the AIS list (see section 12.4.2).

Note 2: When pushing the **ENTER** knob while the detailed data is displayed, you can activate or sleep the AIS target (see section 12.2).

12.4.2 How to display the AIS list

1. Press the **MENU** key to open the main menu.
2. Select [2. OTHER SHIPS LIST].

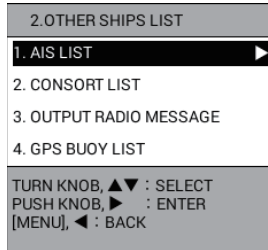

3. Select [1. AIS LIST] to show the AIS list.

AIS LIST				SEL. PAGE _ 1/2▶	
NAME OF SHIP	RNG	BEARING	APPR TME	APPR RNG	
Ship_AIS_20	2.400NM	130.7°M	47m32s	2.396NM	
Ship_AIS_19	2.402NM	128.9°M	48m05s	2.398NM	
Ship_AIS_18	2.407NM	127.1°M	49m16s	2.403NM	
Ship_AIS_17	2.414NM	125.3°M	50m35s	2.410NM	
Ship_AIS_16	2.423NM	123.5°M	52m07s	2.419NM	
Ship_AIS_15	2.435NM	121.8°M	53m27s	2.431NM	
Ship_AIS_14	2.448NM	120.0°M	54m58s	2.444NM	
Ship_AIS_13	2.464NM	118.3°M	56m05s	2.460NM	
Ship_AIS_12	2.483NM	116.6°M	57m35s	2.479NM	
Ship_AIS_11	2.503NM	114.9°M	58m23s	2.499NM	

[CENTER] : CENTER TARGET
 PUSH KNOB : SHOW DETAILS [TRACK COLOR] : CHANGE COLOR
 [PLOT INTVL] : RECORD START/STOP [MENU] : BACK

When [TARGET SMART TRACK] is set to [ON] (see page 9-15), this indication changes as below.

[CENTER] : SMART TRACK SELECTED TARGET

- ◀ or ▶: Shifts the page.
- **CENTER** key: Centers the selected AIS target on the plotter display. When [TARGET SMART TRACK] (see page 9-15) is set to [ON] and [DISPLAY AIS TRACK] (see section 12.3.1) is set to [SHOW], each press of the key centers an AIS target or own ship alternately. For an AIS target, the indication shown in the figure below appears at the top left of the screen.

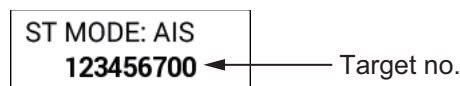

Note: The orientation mode for own ship can not be changed during OS MODE.

- **ENTER** knob: Press the **ENTER** knob to display the detailed data for the selected AIS target (see section 12.4.1).
 - **TRACK COLOR** key: Shows the [CHANGE TRACK COLOR (ALL AIS)] window (see section 12.3.2).
 - **PLOT INTVL** key: Stops or restarts recording of track for the selected AIS target (see section 12.3.3).
4. Press the **DISP** key to close the AIS list and the menu.

12.5 AIS Alarm

12.5.1 How to automatically activate targets

You can get automatic activation of a sleeping AIS target when it enters the alarm area with own ship in the center.

1. Press the **MENU** key to open the main menu.
2. Select [6. ALARM SETTINGS].
3. Select [AIS AUTO ACTIVATION] on page 2.

ALARM SETTINGS		SEL. PAGE _ ◀2/4▶
TRIP RANGE ALARM	: ON	<input type="checkbox"/> OFF
ALARM RANGE	: 0000. 1 NM	
TRIP RANGE RESET		
AIS AUTO ACTIVATION	: <input checked="" type="checkbox"/> ON	OFF
ACTIVATION RANGE	: 02. 0 NM	
IGNORE MOORED SHIPS	: <input checked="" type="checkbox"/> IGNORE	SHOW
MAX. SPD FOR MOORED	: 01. 0 kn	
AIS PROXIMITY ALARM	: ON	<input type="checkbox"/> OFF
ALARM RANGE	: 01. 0 NM	
CPA/TCPA ALARM	: ON	<input type="checkbox"/> OFF
CPA ALARM RANGE	: 01. 0 NM	
TCPA ALARM RANGE	: 00M. 30 S.	
AIS LOST ALARM	: ON	<input type="checkbox"/> OFF
LOST DEL. TIME	: 030 S.	
EXTERNAL AIS ALARM	: ON	<input type="checkbox"/> OFF
WATER TEMP. ALARM	: WITHIN RANGE	OUT OF RANGE <input type="checkbox"/> OFF
LOWEST WATER TEMP.	: +00. 0°C	
HIGHEST WATER TEMP.	: +30. 0°C	
TURN KNOB, ▲▼ : SELECT PUSH KNOB : ENTER [0]~[9] : NO. OF PAGE ◀▶ : MOVE PAGE [MENU] : BACK		

4. Select [ON].
5. Select [ACTIVATION RANGE].
6. Press the numeric keys to set the alarm range (setting range: 0.1 to 99.9 NM).
7. Select [IGNORE MOORED SHIPS].
8. Select [IGNORE] or [SHOW]. When the screen becomes filled with activated targets, they might prevent important radar and AIS displays from being identified. In this case, the targets whose speeds are slower than set with [MAX. SPD FOR MOORED] will not be automatically activated by selecting [IGNORE].
9. Select [MAX. SPD FOR MOORED].
10. Press the numeric keys to set the speed (setting range: 0.1 to 99.9 kn). Any sleeping AIS target, whose speed is slower than this setting, will not be automatically activated.
11. Press the **DISP** key to close the menu.

12.5.2 How to activate the AIS proximity alarm

The proximity alarm alerts you when the range between an AIS target and own ship is within the preset setting.

1. Press the **MENU** key to open the main menu.
2. Select [6. ALARM SETTINGS].

3. Select [AIS PROXIMITY ALARM] on page 2.
4. Select [ON].
5. Select [ALARM RANGE].
6. Press the numeric keys to set the alarm range (setting range: 0.1 to 99.9 NM).
7. Press the **DISP** key to close the menu.

12.5.3 How to set the CPA/TCPA alarm

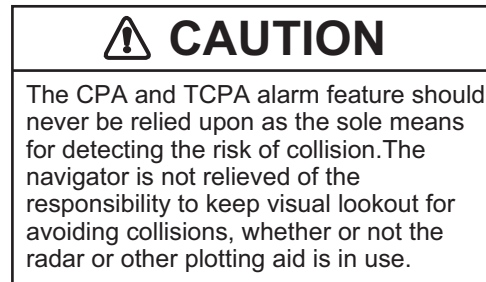

Set CPA (Closest Point of Approach) alarm range and TCPA (predicted Time to CPA) alarm time to alert you to targets that can be on a collision course. The settings are applied to TT targets. When CPA and TCPA of any AIS or TT target become less than the preset CPA and TCPA alarm settings, the audio alarm sounds. The target symbol changes to a dangerous target symbol (AIS: changed to red).

Note: CPA and TCPA ranges must be set up properly taking into consideration the size, tonnage, speed, turning performance and other characteristics of own ship.

1. Press the **MENU** key to open the main menu.
2. Select [6. ALARM SETTINGS].
3. Select [CPA/TCPA ALARM] on page 2.
4. Select [ON].
5. Select [CPA ALARM RANGE].
6. Press the numeric keys to set the alarm range (setting range: 0.1 to 99.9 NM).
7. Select [TCPA ALARM RANGE].
8. Press the numeric keys to set the alarm time (setting range: 30S. to 99M.59S.).
9. Press the **DISP** key to close the menu.

12.5.4 How to set the lost alarm

AIS targets not detected within the time specified become “lost targets”. Set the time as follows.

1. Press the **MENU** key to open the main menu.
2. Select [6. ALARM SETTINGS].
3. Select [AIS LOST ALARM] on page 2.
4. Select [ON].
5. Select [LOST DEL. TIME].
6. Press the numeric keys to set the alarm time (setting range: 3 to 999S.).
7. Press the **DISP** key to close the menu.

12.5.5 How to set the external AIS alarm

The external AIS alarm alerts you when something is wrong with the connected AIS unit.

1. Press the **MENU** key to open the main menu.
2. Select [6. ALARM SETTINGS].
3. Select [EXTERNAL AIS ALARM] on page 2.
4. Select [ON].
5. Press the **DISP** key to close the menu.

13. MAINTENANCE, TROUBLESHOOTING

This chapter contains maintenance and troubleshooting instructions to help you keep optimum performance and the longest possible life of the equipment. Before attempting any maintenance or troubleshooting procedure, please review the safety information below. If you cannot restore normal operation after following the troubleshooting procedures, do not attempt to check inside any unit; there are no operator-serviceable parts inside. Refer any repair work to a qualified technician.

WARNING

ELECTRICAL SHOCK HAZARD
Do not open the equipment.

Only qualified personnel are allowed to work inside the equipment.

NOTICE

Do not apply paint, anti-corrosive sealant or contact spray to coating or plastic parts.

Those items contain organic solvents that can damage coating and plastic parts, especially plastic connectors.

13.1 Maintenance

Check the items shown in the table below regularly to prevent unnecessary trouble.

Check item	Check point	Remedy
Display unit	Dust or dirt on the display	Wipe it carefully to prevent scratching. For difficult to remove dirt or salt deposits, use a cloth made wet with water and neutral detergent (less than 1% detergent). Squeeze the cloth dry then clean the display. When the display is clean, gently wipe the display with a clean, soft, dry cloth, to prevent scratching.
Antenna unit	Loosened and corroded bolts	Tighten loosened bolts. Replace heavily corroded bolts.
Antenna cable	Connection point water-tightness	Replaced damaged parts.
	Connector tightness and corrosion	
	Cable damage	
Display unit connectors	Connector tightness	Re-tighten if necessary.
Ground terminal	Connection tightness and corrosion	Replaced if corroded.
Transducer	Transducer face cleanliness	Marine life on the transducer face can reduce sensitivity. Check the transducer for marine life when the boat is put in drydock. Use a piece of wood to remove any marine life.

13.2 Replacement of Fuse

⚠ WARNING

Use the proper fuse.

Use of the wrong fuse can cause fire or electrical shock.

The fuse on the power cable protects the system from reverse polarity of the ship's mains and equipment fault. If the fuse blows, find the cause before replacing it. Use the correct fuse. Using the wrong fuse will damage the unit and void the warranty.

Name	Type
Glass Tube Fuse	FGBO-A 125V 5A PBF

13.3 Consumable Parts

Consumable parts are used in this equipment. Contact your dealer to replace the part before its expected expiration.

Life of trackball

The life of the trackball is approximately 21,000 hours at the temperature of 40°C. If the trackball (cursor) moves abnormally, ask your dealer about replacement of the trackball. See section 13.4 about trackball maintenance.

13.4 Trackball Maintenance

If the cursor moves abnormally, clean the trackball and inside the trackball housing (including the lens) as shown below:

1. Turn the retaining ring on the trackball module in the direction of the arrows (see figure below) to unlock it, then remove the retaining ring.

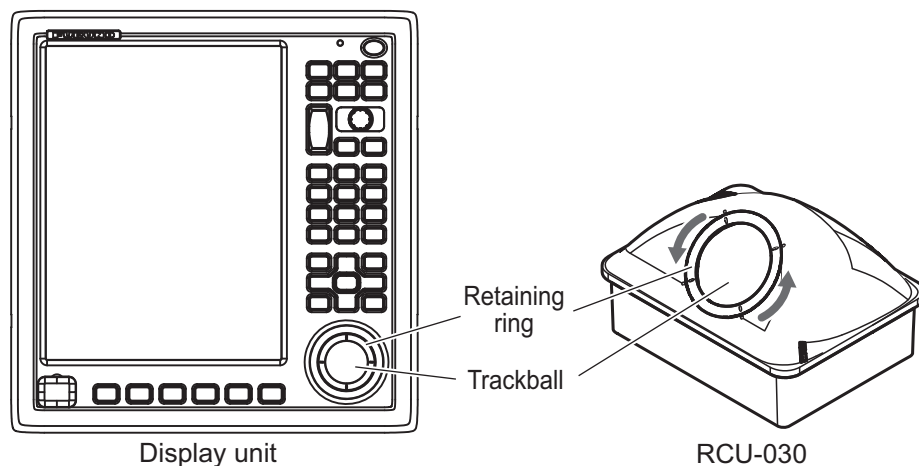

2. Use cellophane tape to remove the trackball from the trackball housing. Place the trackball and the retaining ring on a clean, soft cloth laid on a flat surface.

3. Clean the ball with a damp, soft cloth, then use a dry, lint-free cloth to carefully wipe the ball dry.
4. Use a swab, moistened with water, to carefully clean the inside of the retaining ring, the inside of the trackball housing, the supports and the lens. Change the swab regularly so that dirt and dust build-up is easily removed. Use a dry swab to wipe away moisture.

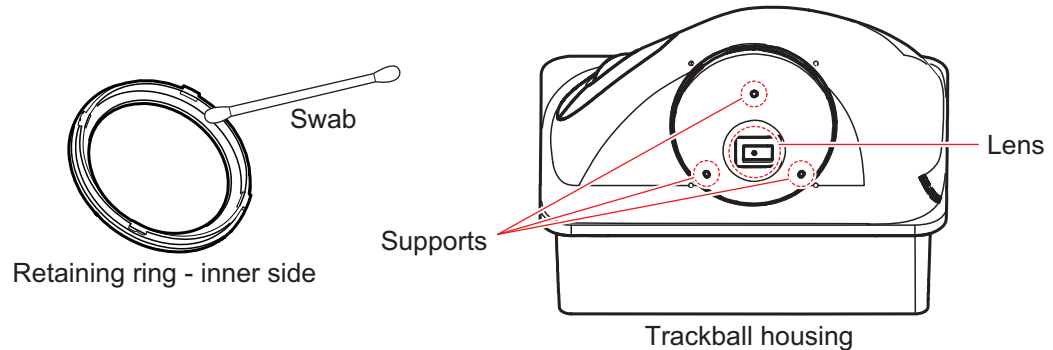

5. Re-set the ball and retaining ring. Be sure the retaining ring is not inserted reversely.

13.5 Troubleshooting

This section provides simple troubleshooting procedures which the user can follow to restore normal operation. If you cannot restore normal operation, do not attempt to check inside the unit. Any trouble should be referred to a qualified technician.

General troubleshooting

Symptom	Remedy
You cannot turn on the power.	<ul style="list-style-type: none"> • Check for blown fuse. • Check that the power connector is firmly fastened. • Check for damaged power cable. • Check battery for proper voltage output. • Press the POWER/BRILL key a little harder.
No picture appears.	Press the POWER/BRILL key to show the brilliance window. Adjust the brilliance.
There is no response when a key is operated.	Turn the power off by one of two methods below and on again. <ul style="list-style-type: none"> • Long-press the POWER/BRILL key on the GP-3700F for 10 seconds. • Turn the main power off and on.

Plotter troubleshooting

Symptom	Remedy
Position is not fixed within 90 seconds.	<ul style="list-style-type: none"> • Check if the antenna connector is firmly connected. • Check the number of satellites being received, on the satellite status/location display.
Position is wrong.	<ul style="list-style-type: none"> • Check that the correct geodetic chart system is selected on the [SYSTEM SETTING] - [NAVIGATOR SETUP] menu (on page 1). • Enter a position offset on the [SYSTEM SETTING] - [NAVIGATOR SETUP] menu (on page 1).
Track for own ship is not plotted.	<ul style="list-style-type: none"> • Check that [DISP. STOPPED TRACKS] in the [MARK/TRACK SETTING] menu is set to [SHOW]. • Check that [DISPLAY TRACKS] in the [MARK/TRACK SETTING] menu is set to [SHOW].
Loran (or Decca) TDs are not displayed.	Check the Loran or Decca chain number on the [PLOTTER DISPLAY SETTING] - [LORAN/DECCA SETTING] menu.
Loran (or Decca) TDs are wrong.	Correctly enter TD offset on the [PLOTTER DISPLAY SETTING] - [LORAN/DECCA SETTING] menu.
Bearing is wrong.	Check the [MANUAL MAG. VAR.] setting in the [SYSTEM SETTING] - [DISPLAY FORMAT] menu.
The ship's speed indication is not zero after the ship is stopped.	Try to decrease the setting for [SPEED AVERAGING] in the [SYSTEM SETTING] - [NAVIGATOR SETUP] menu.
"- -" is displayed for the magnetic bearing (COG, heading, bearing to waypoint).	Check the date. If the date is incorrect, set the year to current one on the [SYSTEM SETTING] - [NAVIGATOR SETUP] - [ROLLOVER] menu.
Data from NMEA2000 equipment are not received.	Turn on the NMEA2000 network power first. If the GP-3700F power is turned on first, restart it.
AIS target without heading data points true north always.	Check the course by displaying the AIS target data (see section 12.4.1).
Date is incorrect. (The GPS is rollover.)	Set the current year on the [SYSTEM SETTING] - [NAVIGATOR SETUP] - [ROLLOVER] menu.
[SHOW MARK COMMENTS] in the [MARK/TRACK SETTING] menu (page 1) is set to [ON CHART] but mark comments are not shown.	When [NUMBER OF RUN DATA MARKS TO DISPLAY] is set to [MAXIMUM NUMBER OF POINTS], marks are not shown even if [SHOW MARK COMMENTS] is set to [ON CHART]. The show mark comments method becomes [IN POPUP] (cursor selection). To always display marks, set [NUMBER OF RUN DATA MARKS TO DISPLAY] to [DEFAULT].

Echo sounder troubleshooting

Symptom	Remedy
Picture does not move, although marks and characters appear.	<ul style="list-style-type: none"> • Check that the picture advance setting in the [ECHO SOUNDER SETTING] menu is set to other than [STOP PICTURE ADVANCE]. • Check if the transducer cable is tightly connected.
Zero line does not appear although the picture appears.	Check if the picture is shifted.

Symptom	Remedy
Picture sensitivity is too low.	<ul style="list-style-type: none"> • Check gain setting if in manual operation. • Marine life or air bubbles may be adhering to the transducer face. • Bottom echo may be too soft to return a suitable echo.
Depth indication is not displayed.	Adjust gain and range settings to display the bottom (in reddish brown), if in manual operation.
Noise or interference appears on the display.	<ul style="list-style-type: none"> • Turn off engine. If noise disappears suspect engine noise. Contact your dealer for advice. • Check the ground for tight connection, rust. • Other sounder of the same frequency as yours may be in the vicinity.
Data is wrong although the water temperature graph appears.	Check if the sensor cable is firmly tightened.

13.6 Unit Information

You can display information about this equipment from the menu.

1. Press the **MENU** key to open the main menu.
2. Select [0. SYSTEM SETTING].
3. Select [0. MAINTENANCE].

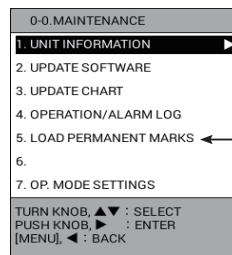

For wind power business

4. Select [1. UNIT INFORMATION].

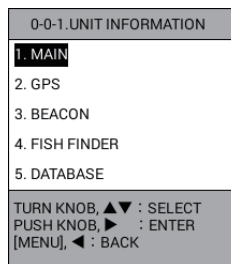

13. MAINTENANCE, TROUBLESHOOTING

- Select [1. MAIN], [2. GPS], [3. BEACON] (an internal beacon receiver required), [4. FISH FINDER] or [5. DATABASE].

GP-3700 MAIN BLOCK	
SERIAL NO.	: XXXX-XXXX
TYPE	
MAIN BOARD	: 14P0441
PANEL BOARD	: 14P0443
PROGRAM VER.	
Power Booter	: 1451469-XX.XX
Power Application	: 1451470-XX.XX
First Booter	: 1451465-XX.XX
Second Booter	: 1451466-XX.XX
Operation System	: 1451467-XX.XX
Application	: 1451468-XX.XX
Panel Ver.	: 1451481-XX.XX
NETWORK	
MAC ADDR (WIRED)	
	: 00:40:9D:7D:CC:1B
CAN ID	
	: C078AF00E7E0006F
RUNNING HOURS	
TOTAL OPERATION TIME (LCD)	: 173H
TOTAL OPERATION TIME (PCB)	: 173H
CONFIRM	

MAIN

DATABASE	
VOICE SYNTH.	: 1451478-XX.XX
PNG Symbols Ver.	: 1451491-XX.XX
CONFIRM	

DATABASE

GPS BLOCK	
GPS BOARD	: 20P8211
OS	: 60000
FIRMWARE	: 17
CLIENT	: 48504650XX
ANTENNA CONNECTOR	: Normal
LATEST GPS DATE	: 2015/01/01 03:32:00
CONFIRM	

GPS

BEACON BLOCK	
BEACON BOARD	: 20P8208
Booter	: 2051543-XX.XX
APPLICATION	: 2051544-XX.XX
CONFIRM	

BEACON

FISH FINDER BLOCK	
FISH FINDER BOARD	: 14P0445
Booter	: 1451471-XX.XX
APPLICATION	: 1451472-XX.XX
TOTAL NO. OF KP TRANSMISSIONS	: 59811
CONFIRM	

FISH FINDER

- Push the **ENTER** knob to close a window.
- Press the **DISP** key to close the menu.

13.7 Operation/Alarm Log

You can check the time when you turned the power on/off or an alarm occurred/ stopped.

- Press the **MENU** key to open the main menu.
- Select [0. SYSTEM SETTING].
- Select [0. MAINTENANCE].
- Select [4. OPERATION/ALARM LOG].

OPERATION/ALARM LOG		SEL. PAGE _ ◀/4▶
NAME	TIME	DETAILS
ALARM28	01/01 09:58:56	STOP FISH ALARM (NORMAL)
ALARM27	01/01 09:58:55	FISH ALARM (NORMAL)
ALARM06	01/01 09:55:51	STOP CROSS TRACK ERROR ALARM
ALARM05	01/01 09:55:32	CROSS TRACK ERROR ALARM
ALARM42	01/01 09:54:50	STOP BOTTOM DISCRIM. ALARM
ALARM40	01/01 09:54:02	STOP FISH SIZE ALARM
ALARM39	01/01 09:53:10	FISH SIZE ALARM
ALARM28	01/01 09:53:08	STOP FISH ALARM (NORMAL)
ALARM27	01/01 09:53:07	FISH ALARM (NORMAL)
ALARM41	01/01 09:52:45	BOTTOM DISCRIMINATION ALARM
ALARM28	01/01 09:50:38	STOP FISH ALARM (NORMAL)
ALARM27	01/01 09:50:37	FISH ALARM (NORMAL)
ALARM16	01/01 09:49:17	STOP WATER TEMPERATURE ALARM
ALARM15	01/01 09:49:11	WATER TEMPERATURE ALARM
ALARM20	01/01 09:48:40	STOP DEPTH ALARM
ALARM19	01/01 09:48:25	DEPTH ALARM
REC.03	01/01 09:00:01	TIME/DATE DATA RECEIVED
REC.01	--/--/--	STARTED GP-3700
REC.02	01/01 12:14:40	SHUTTING DOWN GP-3700
REC.03	01/01 09:00:01	TIME/DATE DATA RECEIVED
[0]~[9] : NO. OF PAGE ◀▶ : MOVE PAGE		
[MENU] : BACK		

- **0** to **9** keys: Enter the page number on [SEL. PAGE] to show the page desired.
For example, press the **0, 5** keys in order, to show the page 5.
 - **◀, ▶**: Shifts the page.
5. Press the **DISP** key to close the log list and menu.

13.8 Diagnostics

This section provides the procedures for testing the equipment for proper operation. Three tests are provided: memory I/O test, keyboard test, and test pattern.

13.8.1 Memory I/O test

The memory I/O test checks the memory and signal I/O circuits and displays the program numbers. The results for the circuit tests are shown as [OK] or [NG] (No Good). If [NG] appears, try the test again. If [NG] still appears, contact your dealer for advice.

Note 1: The test results of [SIO1] to [SIO3], checked using a dedicated connector at the factory, are normally displayed as "NG".

Note 2: The test result of [LAN (WIRED)], [CAN], [USB (FRNT)] or [USB (BACK)] is displayed as "NG" without connection to each port.

1. Press the **MENU** key to open the main menu.
2. Select [0. SYSTEM SETTING].
3. Select [6. TEST & MEMORY CLEAR].

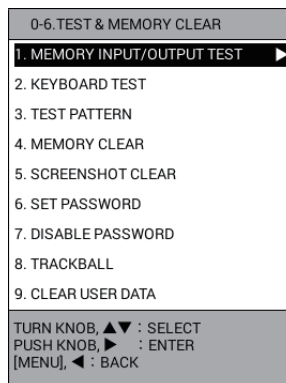

13. MAINTENANCE, TROUBLESHOOTING

4. Select [1. MEMORY INPUT/OUTPUT TEST] to start the memory I/O test.

Test results of [SIO1] to [SIO3] are normally displayed as "NG". Test result of [LAN (WIRED)], [CAN], [USB (FRNT)] or [USB (BACK)] is displayed as "NG" without connection to each port.

MEMORY INPUT/OUTPUT TEST		Total Count: 1	
Start Time: 2015/01/01 12:33			
Main		Power	
SERIAL NUMBER		Bootloader Ver.	1451469-XX.XX
Application	1451468-XX.XX	Application Ver.	1451470-XX.XX
VOICE SYNTH.	1451478-XX.XX	SELF TEST RESULT	OK(NG:0)
PNG Symbols Ver.	1451491-XX.XX	POWER SOURCE VOLTAGE	11.8volt
BOARD VERSION	14P0441.0	GPS	
First Booter	1451465-XX.XX	OS Ver.	60000
Second Booter	1451466-XX.XX	Firmware Ver.	17
Operating System	1451467-XX.XX	PROGRAM VER.	4850465008
CPU	44000	BOARD VERSION	20P8211:1
SIO1	NG(1)	SELF TEST RESULT	OK(NG:0)
SIO2	NG(1)	ANTENNA SHORT	OK(NG:0)
SIO3	NG(1)	DETECTION TEST	OK(NG:0)
LAN (WIRED)	OK(NG:0)	Beacon	
CAN	OK(NG:0)	Boot ver.	2051543-XX.XX
USB(FRNT)	OK(NG:0)	Application Ver.	2051544-XX.XX
USB(BACK)	OK(NG:0)	BOARD VERSION	20P8208:0
INTERNAL MEMORY	OK(NG:0)	ROM TEST	OK(NG:0)
PNL BRILL	OFF	RAM TEST	OK(NG:0)
TOTAL LCD RUNNING HOURS	173h43m55s	ANTENNA SHORT	OK(NG:0)
INT BUZZER	OK(NG:0)	DETECTION TEST	OK(NG:0)
SPEAKER	OK(NG:0)	ES	
RUNNING HOURS	3h33m15s	Boot ver.	1451471-XX.XX
TOTAL RUNNING HOURS	173h43m59s	Application Ver.	1451472-XX.XX
EVENT SWITCH1	OFF	TOTAL KP TX COUNT	59811TIMES
EVENT SWITCH2	OFF	HF RECEIVED ECHO LEVEL	7515
BK	OFF	LF RECEIVED ECHO LEVEL	16560
		ROM TEST RSLT	OK(NG:0)
		RAM TEST RSLT	OK(NG:0)
		Panel	
		Panel Ver.	1451481-XX.XX
		BOARD VERSION	14P0443:0

"- -" is displayed for non-DGPS specification.

XX: Program version numbers

5. Press the **DISP** key to close the test screen and the menu.

13.8.2 Keyboard test

The keyboard test checks the controls on the display unit for proper operation.

1. Press the **MENU** key to open the main menu.
2. Select [0. SYSTEM SETTING].
3. Select [6. TEST & MEMORY CLEAR].
4. Select [2. KEYBOARD TEST] to show the keyboard test screen.

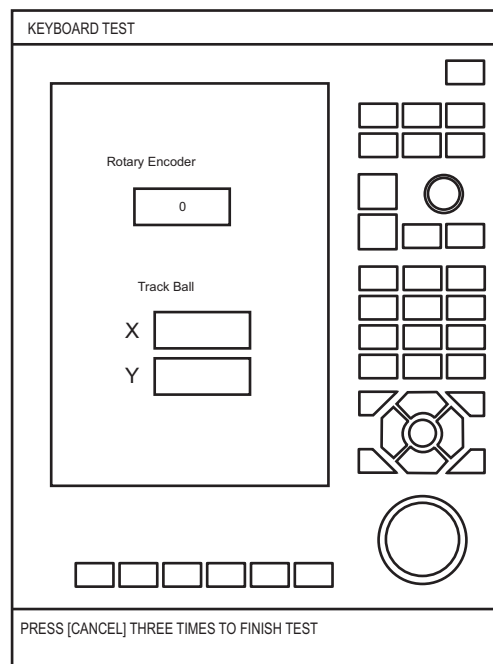

5. Operate each control on the display unit one by one.
 - A key is functioning correctly if its on screen location "fills" in light-blue when the key is pressed. Each press switches light-blue and white alternately.

- The **ENTER** knob is functioning correctly if its on screen location “fills” in light-blue when the knob is pushed. Each push switches light-blue and white alternately. Rotate the **ENTER** knob clockwise to increase the value on [Rotary Encoder], counterclockwise to decrease the value.
 - Rotate the trackball to the right or down to increase the value on [Track Ball], to the left or up to decrease the value.
6. Press the **CANCEL** key three times to quit the test.
 7. Press the **DISP** key to close the menu.

13.8.3 Test pattern

The test pattern checks the display colors.

1. Press the **MENU** key to open the main menu.
2. Select [0. SYSTEM SETTING].
3. Select [6. TEST & MEMORY CLEAR].
4. Select [3. TEST PATTERN] to start the display test. Each push of the **ENTER** knob changes the LCD pattern in the sequence shown below.

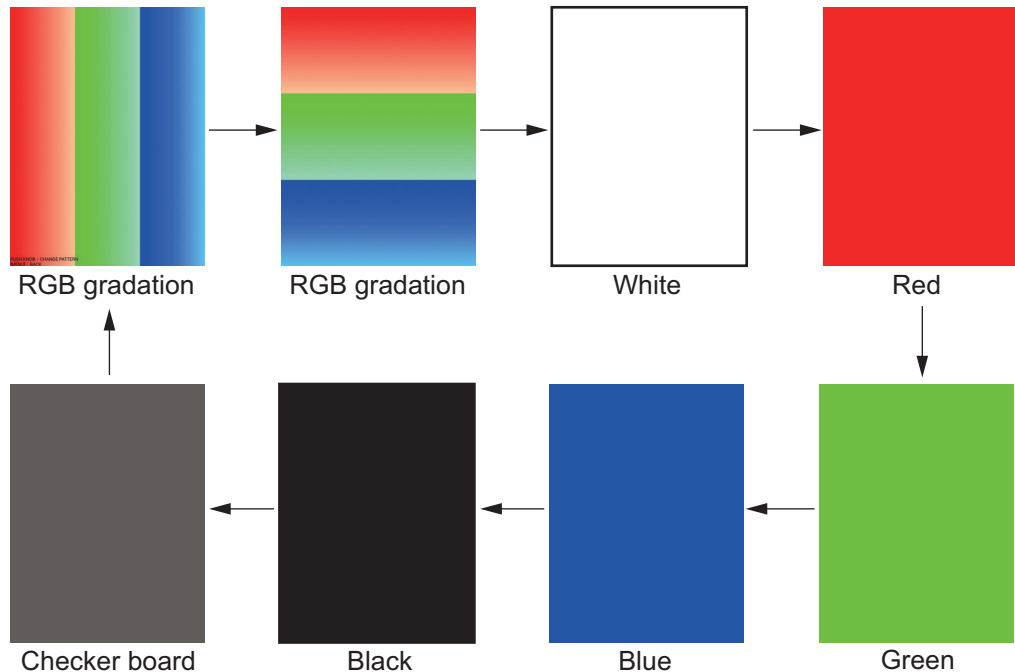

5. Press the **DISP** key to close the test screen and the menu.

13.9 How to Clear the Memory

The user settings can be cleared to restart operation with default settings. Also, you can delete user data (tracks, marks, waypoints and routes) or all screenshot data.

13.9.1 How to restore the settings

1. Press the **MENU** key to open the main menu.
2. Select [0. SYSTEM SETTING].
3. Select [6. TEST & MEMORY CLEAR].

13. MAINTENANCE, TROUBLESHOOTING

4. Select [4. MEMORY CLEAR] to show the following message.



5. Select [RUN] to restore the settings. The equipment automatically restarts.

13.9.2 How to delete all screenshot data

1. Press the **MENU** key to open the main menu.
2. Select [0. SYSTEM SETTING].
3. Select [6. TEST & MEMORY CLEAR].
4. Select [5. SCREENSHOT CLEAR] to show the following message.



5. Select [RUN] to delete all screenshot data. The message "DELETION COMPLETED" appears.
6. Push the **ENTER** knob.
7. Press the **DISP** key to close the menu.

13.9.3 How to delete user data

1. Press the **MENU** key to open the main menu.
2. Select [0. SYSTEM SETTING].
3. Select [6. TEST & MEMORY CLEAR].
4. Select [9. CLEAR USER DATA] to show the following message.

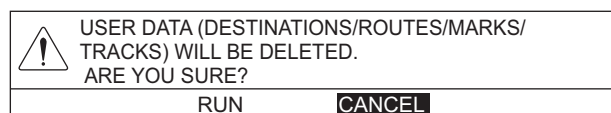

5. Select [RUN] to delete the user data. The message "DELETION COMPLETED" appears.
6. Push the **ENTER** knob.
7. Press the **DISP** key to close the menu.

APPX. 1 MENU TREE

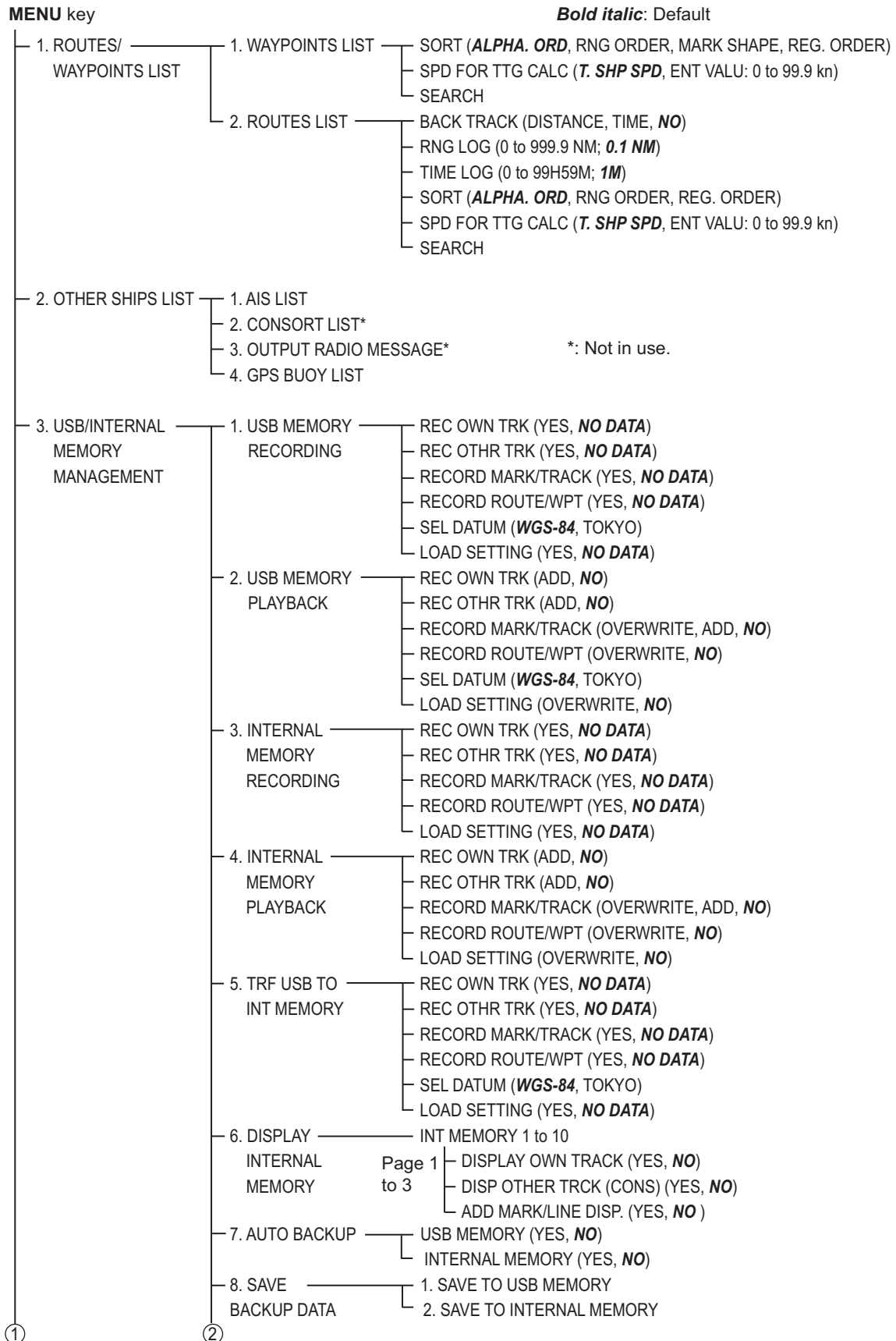

APPX. 1 MENU TREE

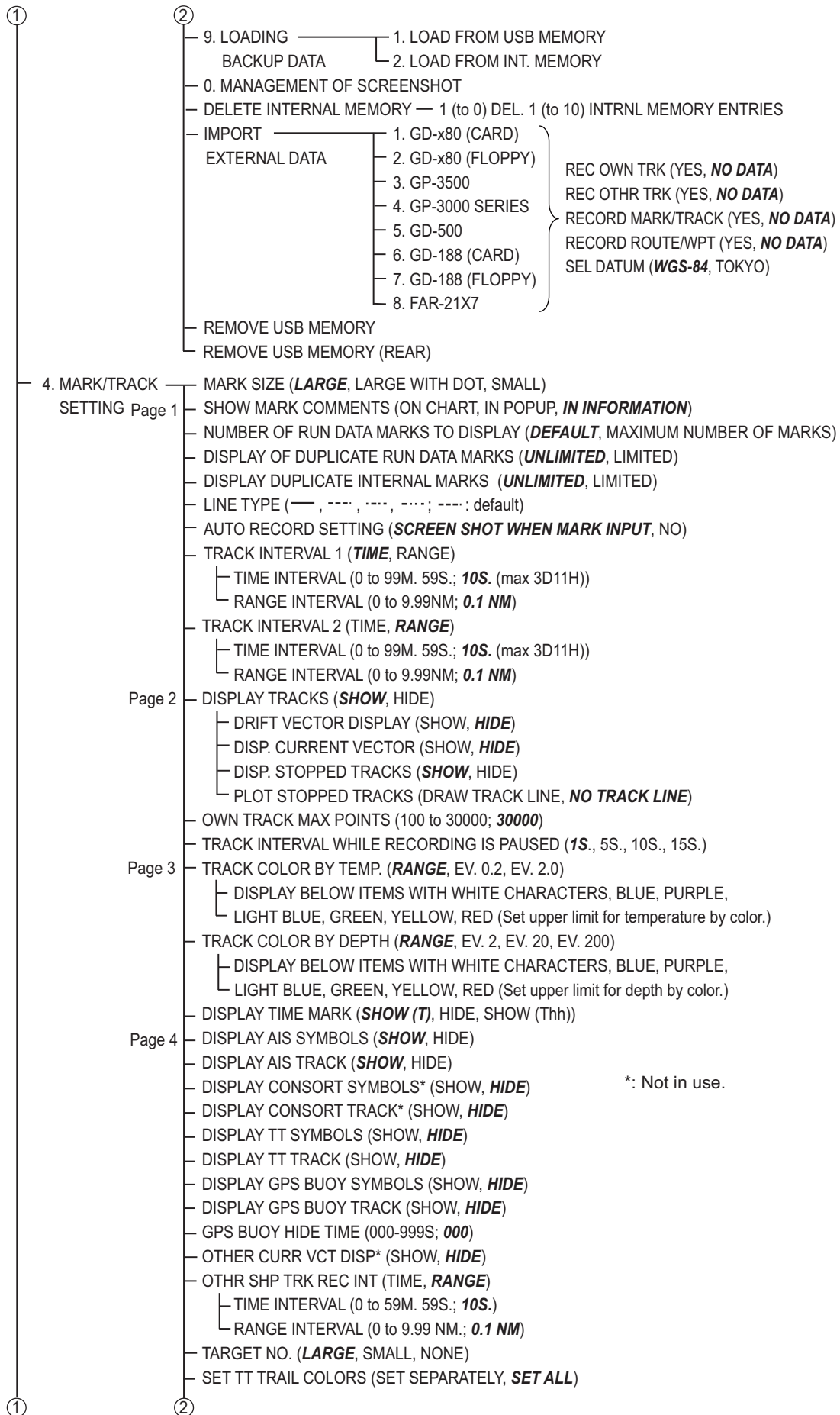

*: Not in use.

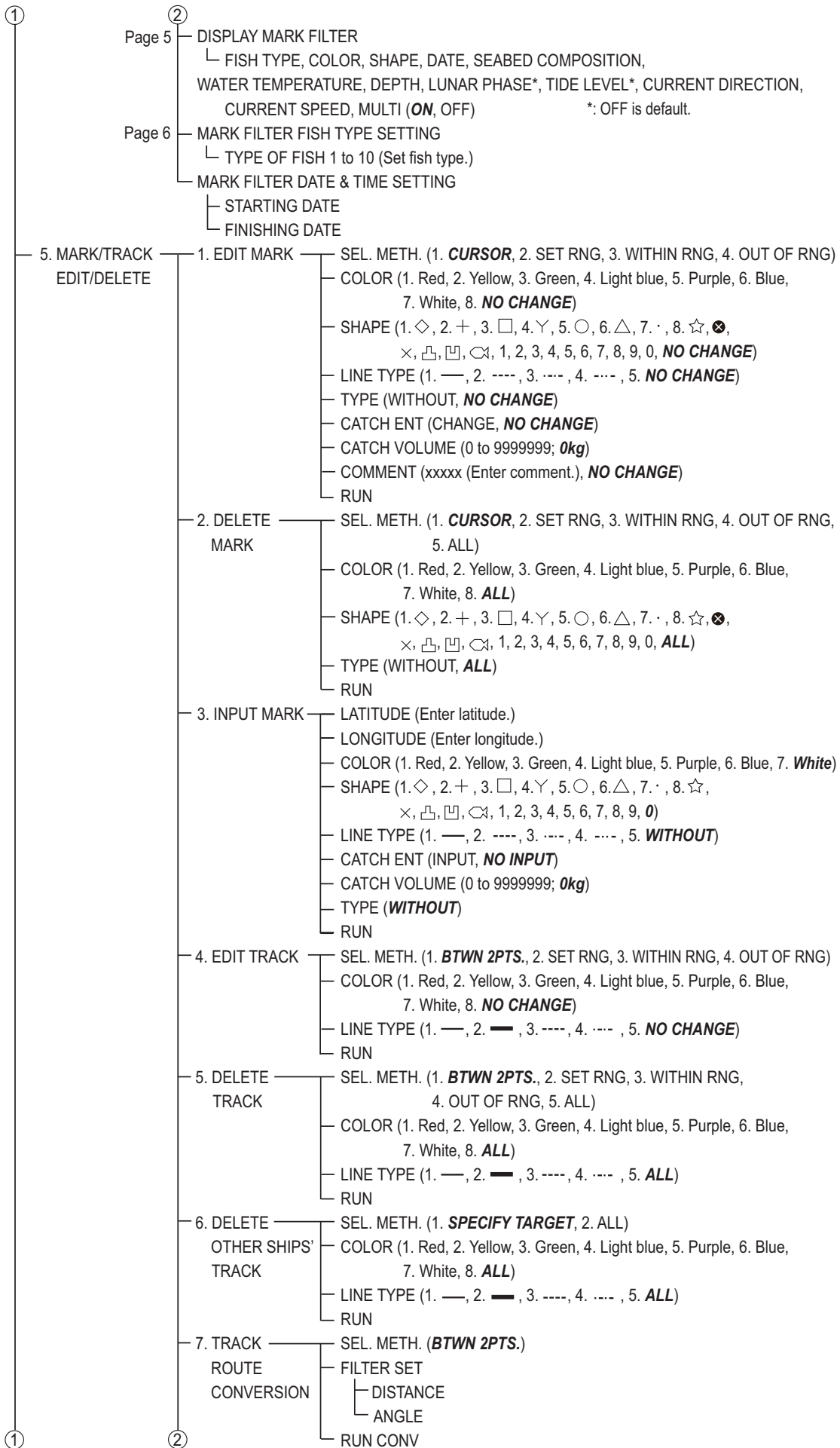

APPX. 1 MENU TREE

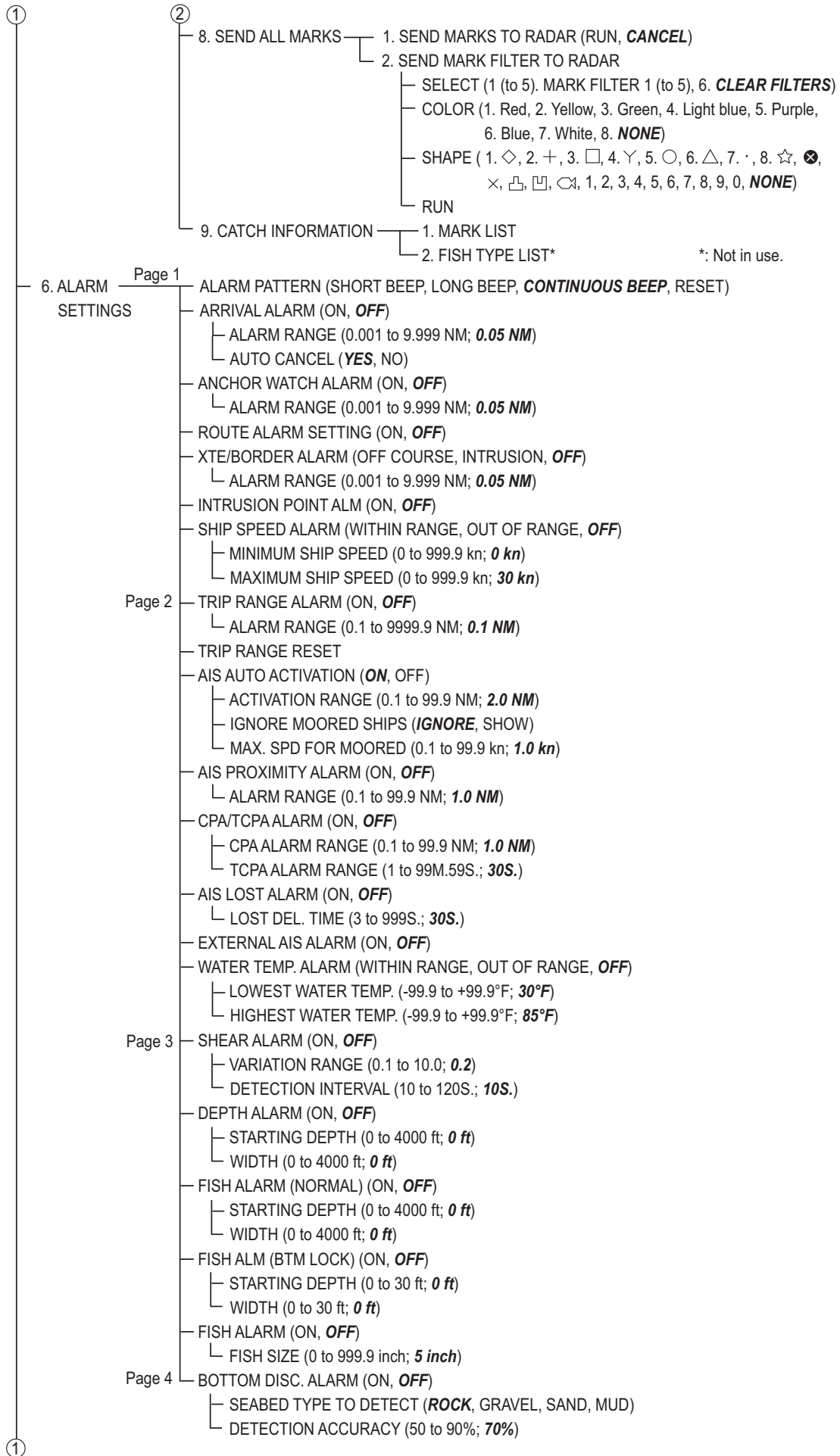

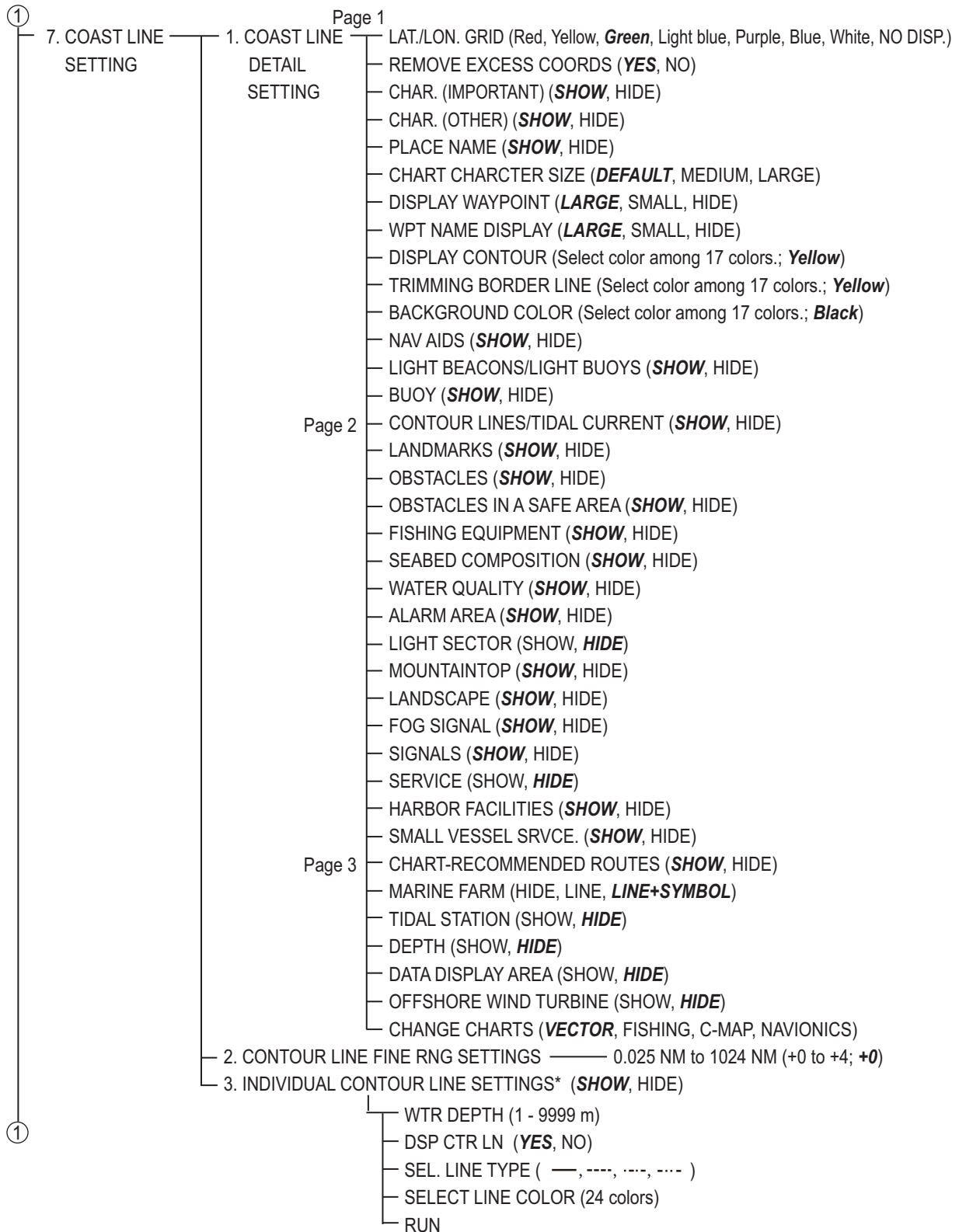

APPX. 1 MENU TREE

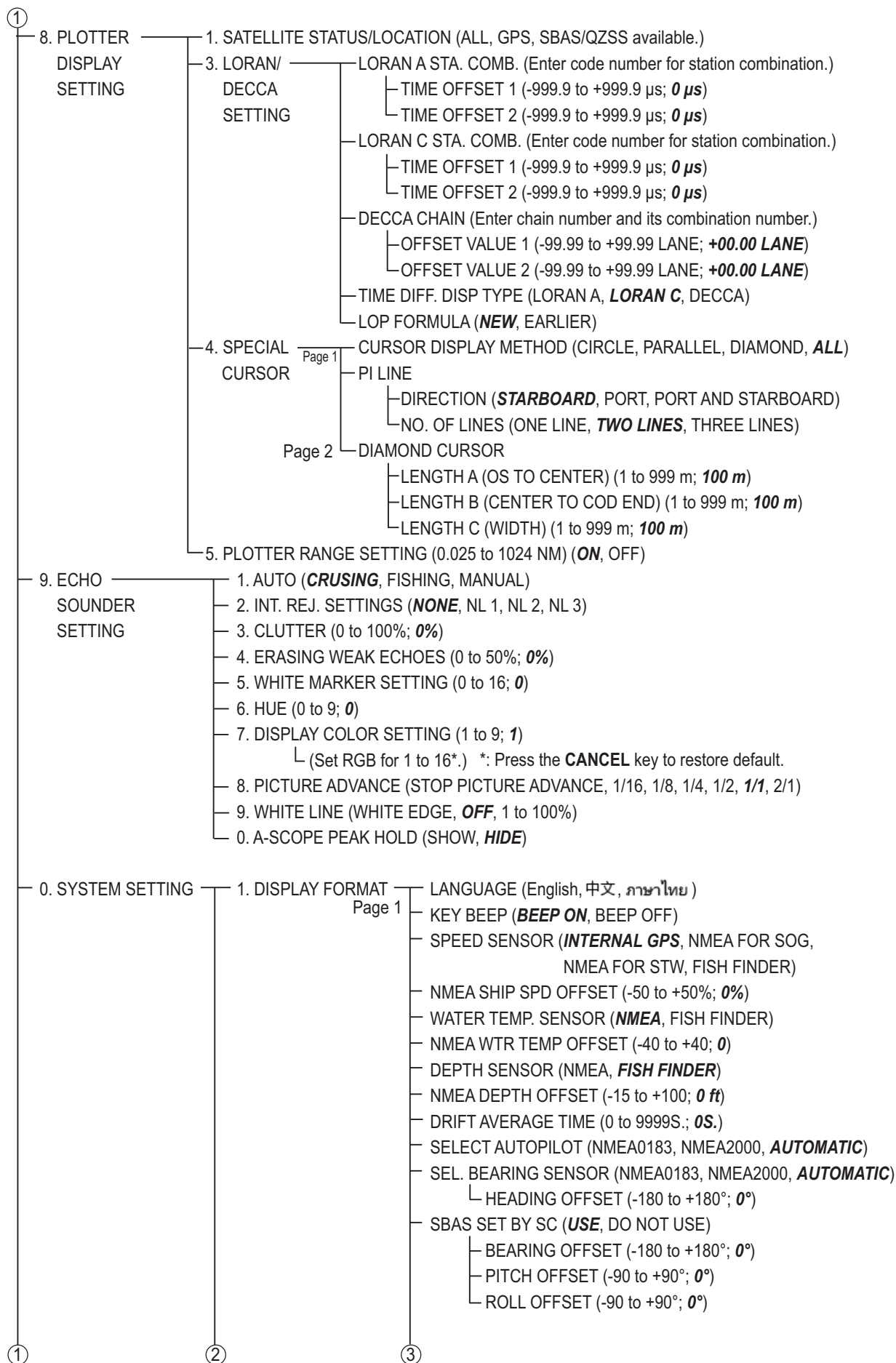

②	③	
Page 2		LAT./LON. GRID (DD°MM.MM', DD°MM.MMM', DD°MM.MMMM' , DD°MM'SS.S")
		RANGE/SPEED (NM, kn , km, km/h, SM, mph)
		WIND SPEED (kn , m/s, mph)
		DEPTH (m, ft , fm, HIRO)
		└ HIRO SETTING (1 to 1.9999; 1.5152)
		WATER TEMPERATURE (°C, °F)
		TIME (12 HOURS, 24 HOURS)
		BEARING MODE (TRUE DIRECTION, MAGNETIC DIR.)
		MAGNETIC BRG OFFSET (AUTOMATIC , MANUAL)
		MANUAL MAG. VAR. (99.9°W to 99.9°E; 7°W)
		DISP. HDG MARKER (SHOW, VECTOR , HIDE)
		DISP. COG MARKER (SHOW , VECTOR, HIDE)
		WPT. REFRESH SETTING (WPT ON VERTICAL LINE , ARRIVE ALARM WITHIN RANGE)
Page 3		RING & BRG MODE (GREAT CIRCLE, RHUMBLINE)
		SET GOTO METHOD (ONE POINT , 100 POINTS)
		RANGE/SCALE (RANGE , SCALE, HIDE)
		SCALE DISPLAY (SHOW , HIDE)
		GPS STATUS (SHOW , HIDE)
		WAYPOINT STATUS (SHOW , HIDE)
		WAYPOINT INFORMATION (SHOW , HIDE)
		DISPLAY MARK INFO. (SHOW , HIDE)
Page 4		SHOW OBJECT INFORMATION (SHOW , HIDE)
		OWN SHIP'S MARK (LARGE , SMALL, SHAPE OF SHIP)
		SHIP'S LENGTH (0.1 to 99.9 m; 10 m)
		SHIP'S WIDTH (0.1 to 99.9 m; 2 m)
		ANTENNA POSITION V a (0.1 to 99.9 m; 5 m)
		ANTENNA POS. SIDE b (0.1 to 99.9 m; 1 m)
		WAYPOINT OVERWRITE (CONFIRM , CANCEL)
		COG HOLD (LOW SPD) (YES (1kn) , YES (0.2kn), NO)
		WPT NAME DISPLAY (HIDE UNNECESSARY "0", DISPLAY ALL "0")
		SHIP'S DIRECTION (COG , HEADING)
		CURSOR SHAPE (CROSSING LINE , CROSS HAIR)
		CURSOR COLOR (Red, Yellow, Green, Light blue, Purple, Blue, White)
Page 5		DISPLAY OWN SHIP (SHOW , HIDE)
		OTHR SHIP INFO DISP. (SHOW , HIDE)
		VIDEO PILOT (WITH, NO)
		DRIFT/CURR. VCTR DISPLAY (TO , FROM)
		DISPLAY OS DRIFT VECTOR (SHOW, HIDE)
		OS CURR. VECTOR DISP (SHOW, HIDE)
		OTHER CURR VCT DISP* (SHOW, HIDE) *: Not in use.
		CURRENT DISPLAY 1 (1 L. to 5 L.; 1 L.)
		CURRENT DISPLAY 2 (1 L. to 5 L.; 2 L.)
		CURRENT DISPLAY 3 (1 L. to 5 L.; 3 L.)
		VECTOR DISPLAY LENGTH (1(SHORT) , 2, 3, 4(LONG))
		TARGET SMART TRACK (ON, OFF)
		ENTER MOB (OWN SHIP , CURSOR)
		NAV. DATA TRANSPARENCY (0 to 99; 50)
		INFORMATION TRANSPARENCY (0 to 99; 50)
Page 6		BKGD/LETTER COLOR (WHITE ON BLUE BACKGROUND , BLACK ON WHITE BACKGROUND, WHITE ON BLACK BACKGROUND, GREEN ON BLACK BACKGROUND)
		EVENT SWITCH 1 (NONE , ENTER MOB, SCREEN SHOT, INPUT MARK)
		EVENT SWITCH 2 (NONE , ENTER MOB, SCREEN SHOT, INPUT MARK)
		POP UP MESSAGES* (DISPLAY , NO DISPLAY)
②		

APPX. 1 MENU TREE

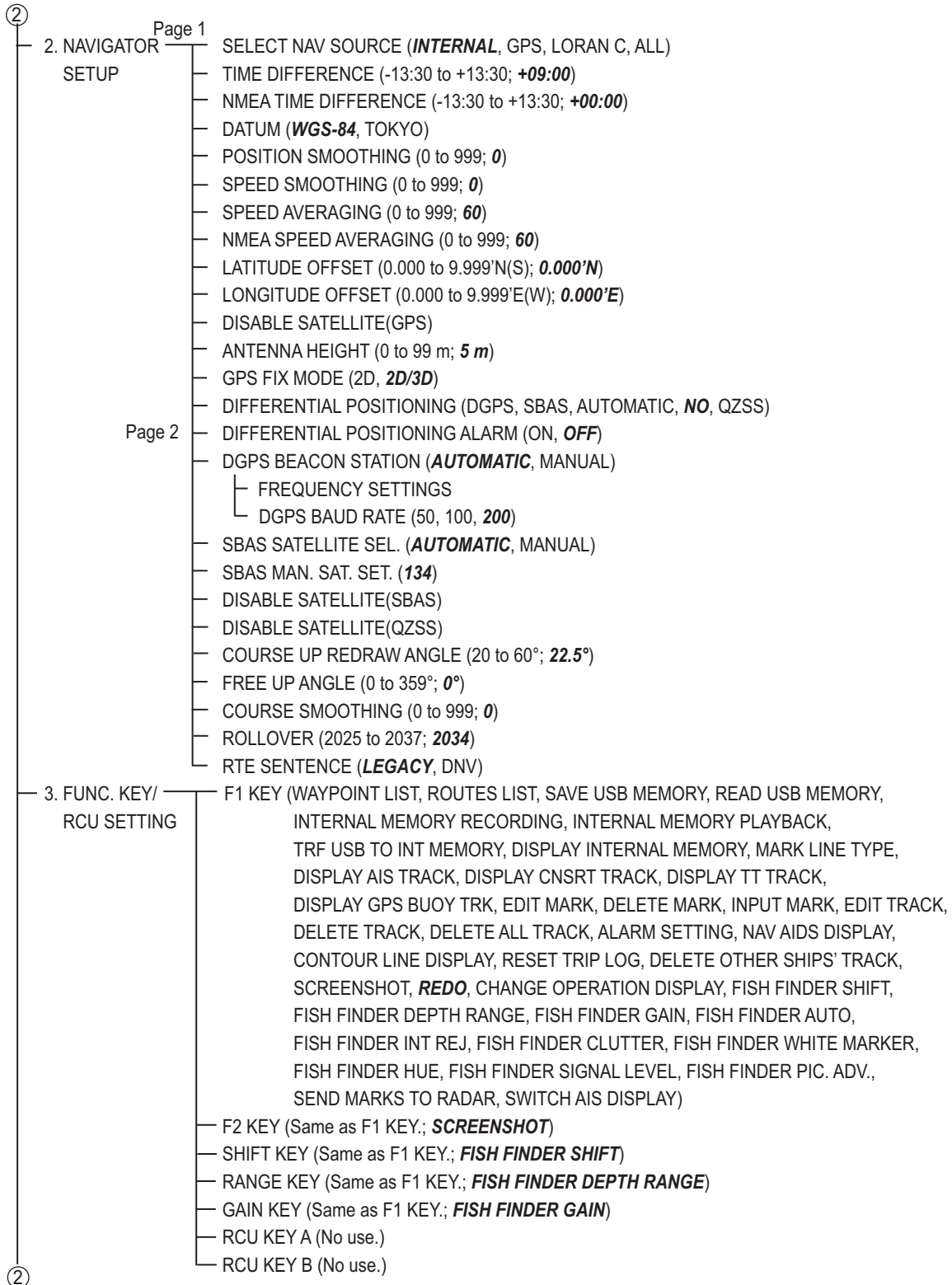

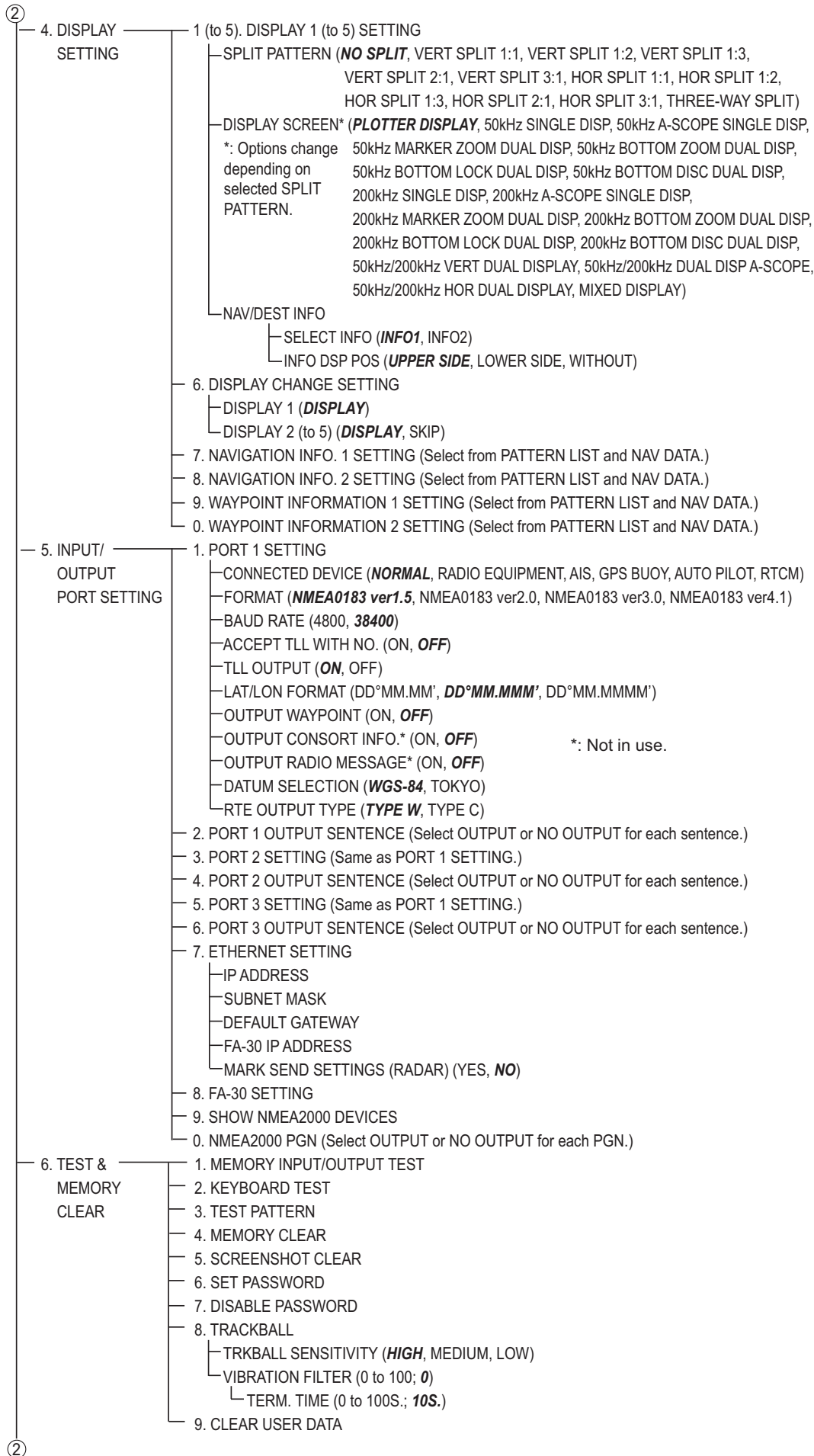

APPX. 1 MENU TREE

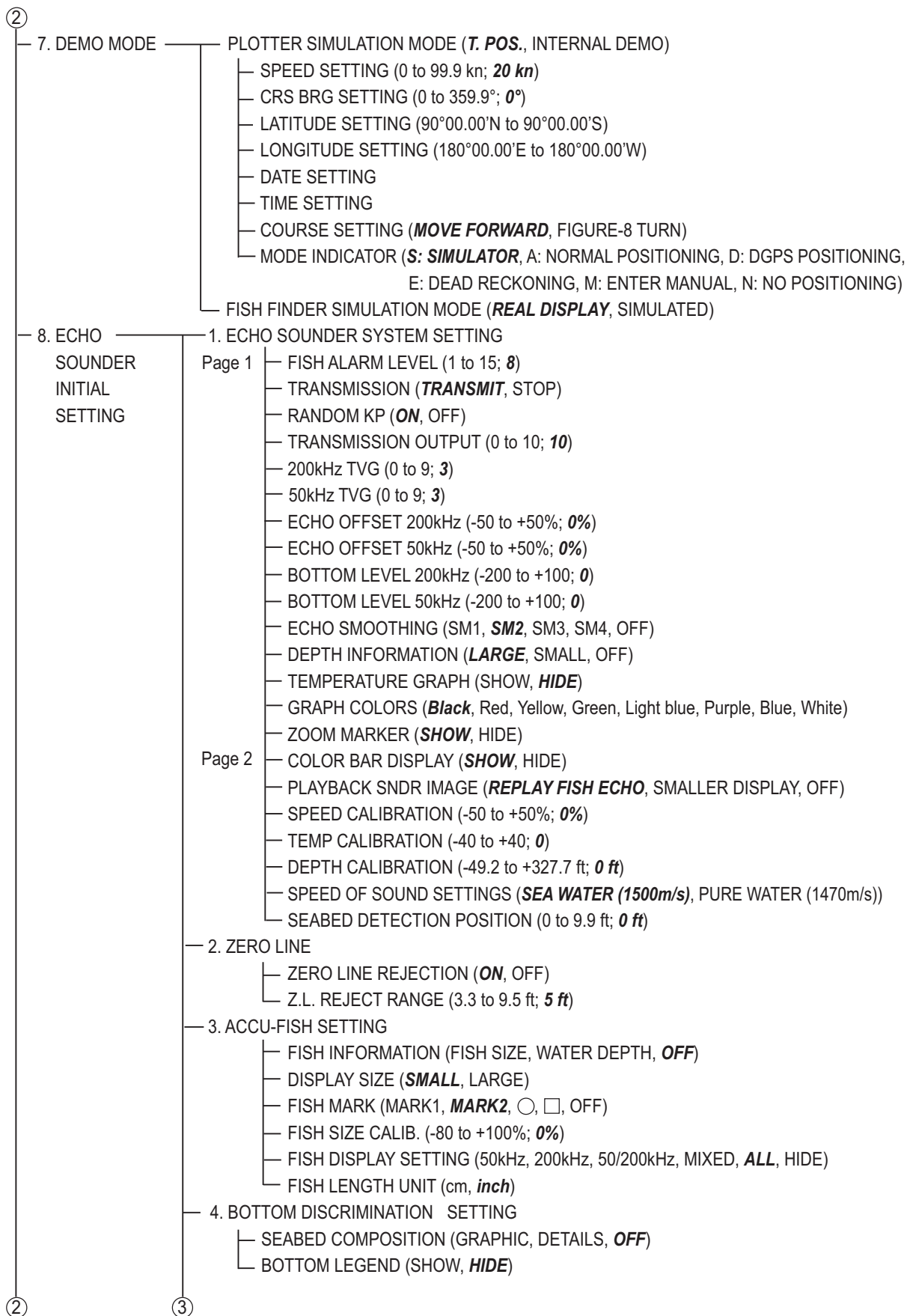

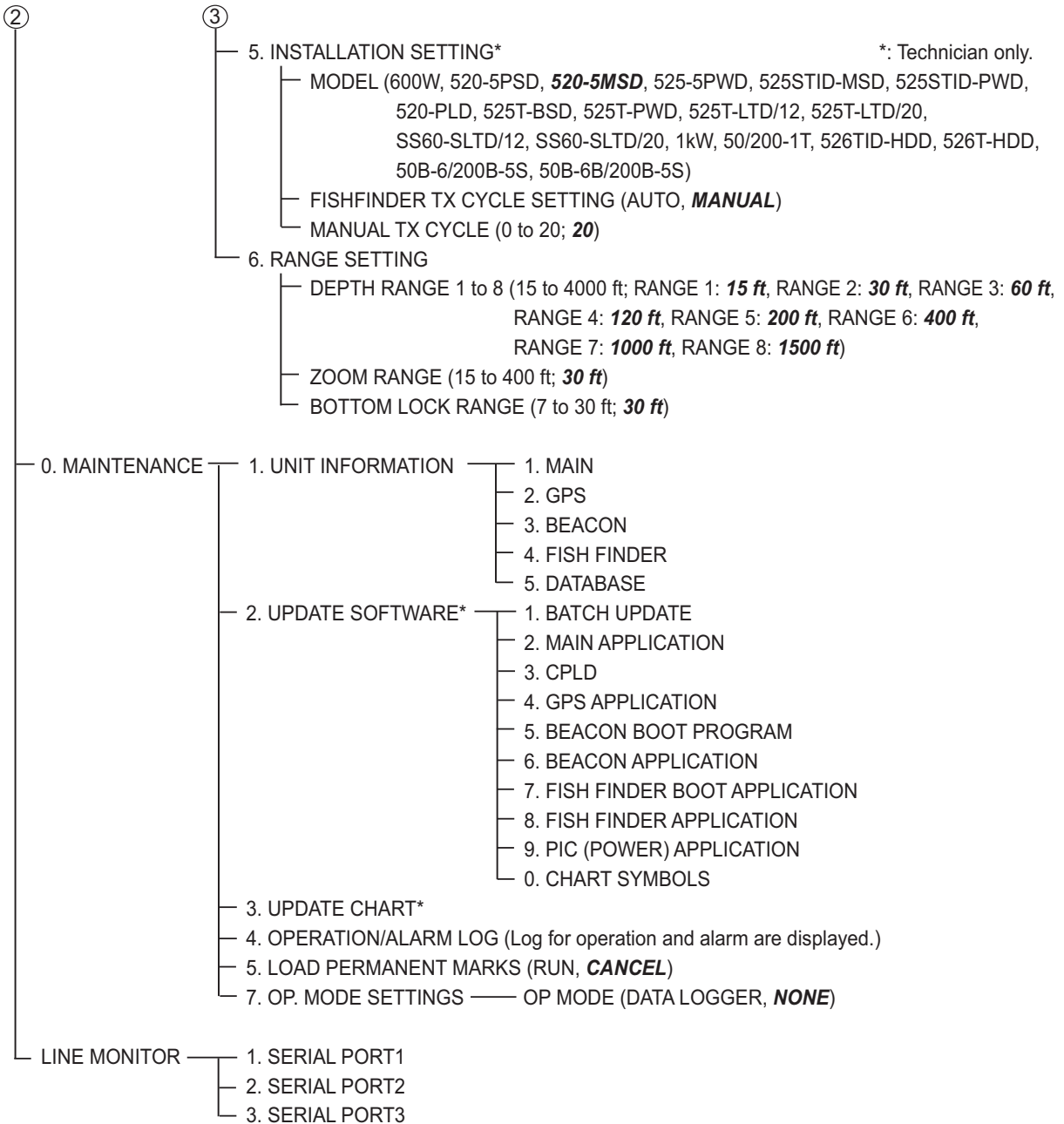

APPX. 2 ICONS

Icon	Meaning
	Mark
	Cursor (left: crossing line, right: cross-hair)
	Own ship (during track recording: filled, during stopping track recording: empty)
	MOB (left: normal (own ship position), middle: small (own ship position), right: cursor position)
	North mark
	TLL symbol (as an waypoint)
	State of chart (left: suitable chart scale, middle: unsuitable chart scale, right: no chart file)
	Shape of mark (left: numeral, right: graphic) Note: When excess points are culled, the icon color changes from white to yellow (see page 2-1).
	Latitude and longitude position offset applied.
	Track is not being recorded.
	Voyage-based route is being created.
	Track interval
	Alarm
	Currently active screen
	Demo mode
	Wind direction
	Tidal station (Its appearance changes according to the tide height.)
	XTD (cross track distance) on the compass display
	Direction to steer on the compass display
	Fish mark (upper: large fish, lower: small fish)
	State of communication between the FR-12 (with RT board) and the GP-3700F (left: sending marks data, middle: transmission is available, right: transmission is not available)
	Data logger function is activated.

APPX. 3 TIME DIFFERENCES

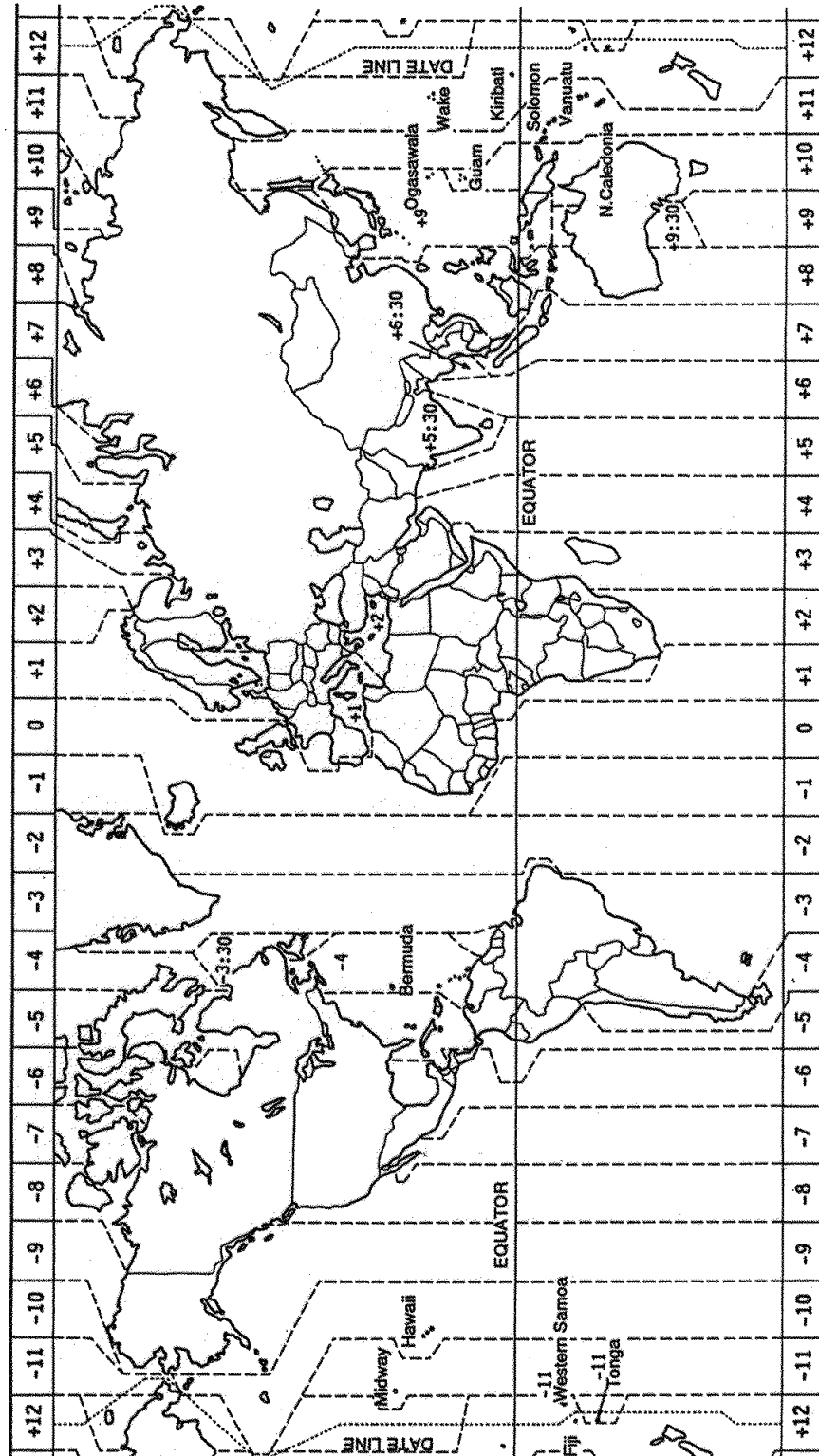

APPX. 4 WHAT IS SBAS/QZSS(SLAC)/DC REPORT?

SBAS

A satellite based augmentation system, or SBAS (Satellite Based Augmentation System), is an augmentation system that uses additional messages from satellite broadcasts to support regional and wide area augmentation. SBAS provides GPS signal corrections to SBAS users, for even better position accuracy, through the GPS error corrections that are widely broadcasted from the geostationary satellite.

SBAS is used in America, Europe, Japan and India. These four systems; WAAS, EGNOS, MSAS and GAGAN, have interoperability. The illustration below shows the coverage area for each provider. This manual uses "SBAS" for these four providers generically.

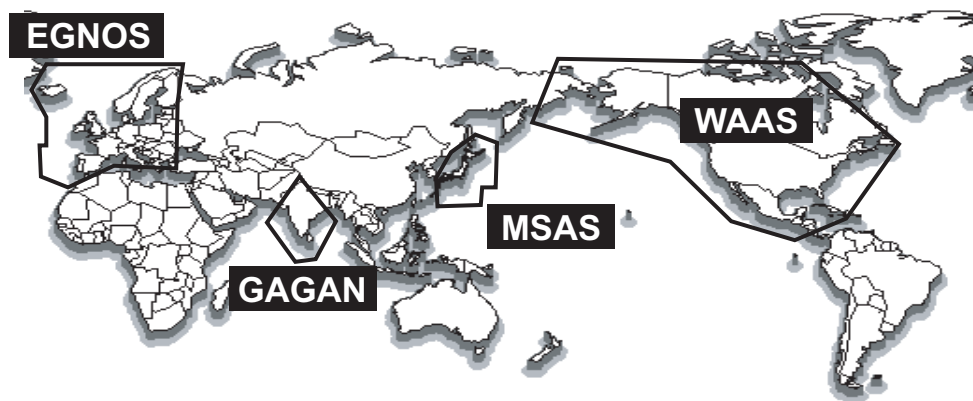

Provider	Satellite type	Longitude	Satellite No.
WAAS (Wide Area Augmentation System, America)	Intelsat Galaxy XV	133°W	135
	TeleSat Anik F1R	107.3°W	138
	Inmarsat-4-F3	98°W	133
EGNOS (Euro Geostationary Navigation Overlay Service, Europe)	Inmarsat-3-F2/AOR-E	15.5°W	120
	Artemis	21.5°E	124
	Inmarsat-4-F2	25°E	126
	SES-5	5°E	136
MSAS (Multi-Functional Satellite Augmentation System, Japan)	MTSAT-1R	140°E	129
	MTSAT-2	145°E	137
GAGAN (GPS And GEO Augmented Navigation, India)	GSAT-8	55°E	127
	GSAT-10	83°E	128

As of March 6th, 2014

QZSS (SLAS)

QZSS (SLAS) (Quasi-Zenith Satellite System) is the Japanese satellite positioning system composed mainly of satellites of quasi-zenith orbit. Since QZSS can be used together with GPS, QZSS secures the number of satellites that can perform stable high-accuracy positioning.

Note: Positioning correction cannot be guaranteed outside of the coverage area.

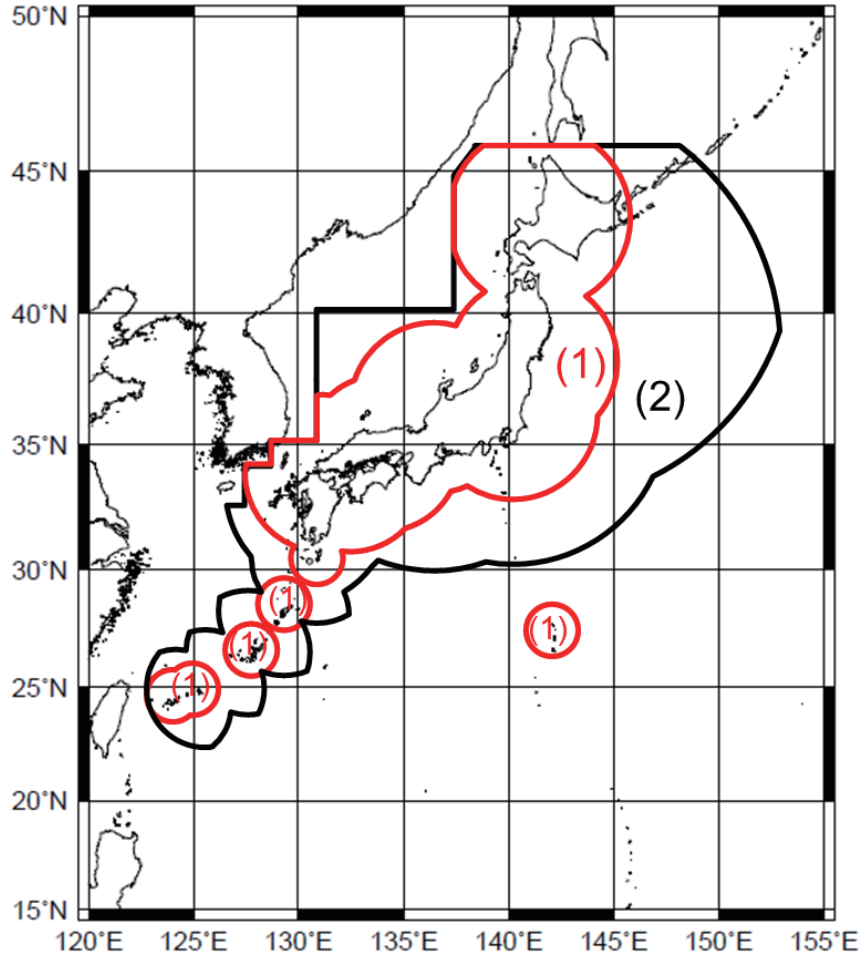

Source: Cabinet Office, Government of Japan, “PS-QZSS-001”, November 5, 2018, Figure 5.2-1 on page 16

The table below shows the positioning accuracy when using SLAS correction.

Positioning accuracy

Area	Positioning error (Horizontal)
Areas (1) and (2)	3.0 m approx. (2 drms)

APPX. 4 WHAT IS SBAS/QZSS(SLAC)/DC REPORT?

The table below shows the available QZSS (SLAS) satellites.

QZSS (SLAS)

Satellite name	Longitude	Satellite no.	PRN for positioning	PRN for correction
QZS-1	-	J001	193	183
QZS-2	-	J002	194	184
QZS-3	127°E	J003	199	189
QZS-4	-	J004	195	185

As of February 25th, 2019

The QZSS ground track is a figure eight track shown in the figure below. Satellites remain in the northern hemisphere for about 13 hours, and about 11 hours in the southern hemisphere.

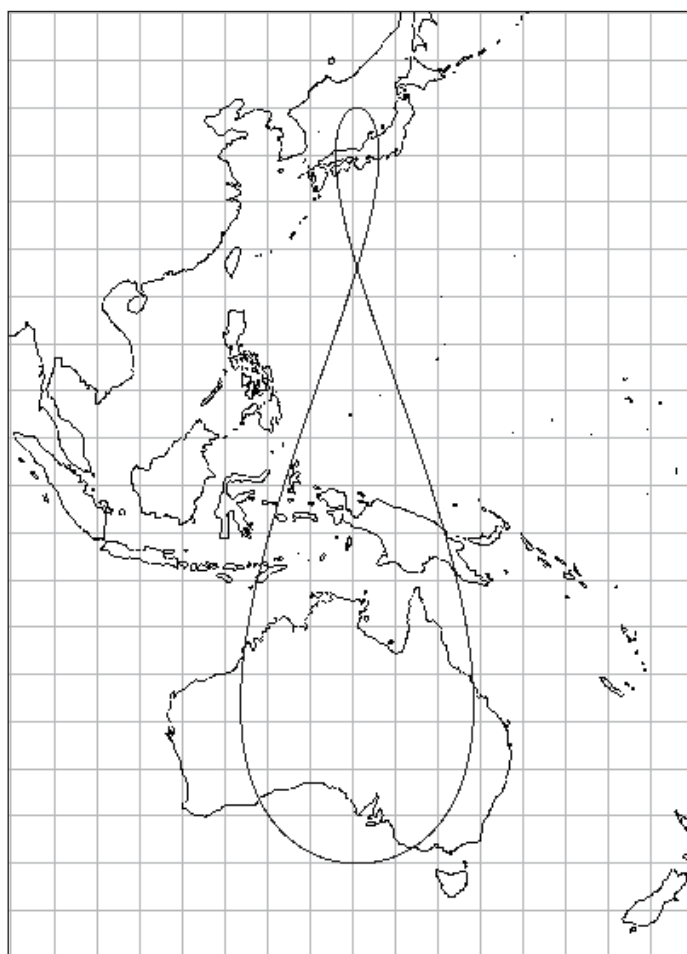

QZSS ground track (except for QZS-3)

Source: Cabinet Office, Government of Japan, "PS-QZSS-001", November 5, 2018, Figure 3.1-2 on page 9

APPX. 5 ALARM LIST

When an alarm occurs, the alarm icon and type appear at the bottom of the screen. When turning on the audio alarm, the buzzer sounds (see section 8.1). Also, when setting [ALARM] to display in the NAV information box, the alarm title appears in the box (see section 1.4.4 and section 2.1.2).

The table below shows the alarm title, meaning and remedy for each alarm. You may silence the buzzer by pressing the **CANCEL** key.

Title (indication in the information box)	Meaning	Remedy
POSN N/A	No calculation of position. The signal from GPS core is not received for three seconds.	Restart the GP-3700F. If the alarm occurs again, contact your dealer.
NO FIX	No positioning data.	If the same state continues for five minutes, contact your dealer.
DGPSLOST	The positioning system changes from DGPS (or SBAS) to GPS (see [DIFFERENTIAL POSITIONING ALARM] on page 9-18).	If this condition frequently occurs in the service area of the Beacon stations or the SBAS satellites, contact your dealer.
ARRIVAL	Your vessel is approaching a destination waypoint (see section 8.2).	-
DEPARTURE	Your vessel is moving when it should be at rest (see section 8.2).	Confirm own ship location and adjust as necessary.
XTE ERR	Your vessel is off its intended course (see section 8.4).	Check course and adjust as necessary.
INTRUSION	Your vessel crosses the area defined by the two waypoints (see section 8.4).	Check course and adjust as necessary.
SPEC OBJ	Your vessel nears a waypoint by the distance set for that waypoint on the waypoints list (see section 8.5 and section 5.1.3).	Confirm the proximity waypoint.
SPEED	Your boat's speed is within the speed range set (see section 8.6).	Check own ship's speed and adjust as necessary.
SPEED	Your boat's speed is over the speed range set (see section 8.6).	Check own ship's speed and adjust as necessary.
TRIP	You have traveled a certain distance (see section 8.7).	Reset the trip distance as necessary.
AIS PROX.	The range between an AIS target and your ship is within the preset setting (see section 12.5.2).	Confirm the location of the approximate AIS target.
CPA/TCPA	AIS/TT target is within CPA/TCPA threshold (see section 12.5.3).	Take evasive action if necessary. Adjust CPA/TCPA settings.
AIS LOST	AIS target is lost (see section 12.5.4).	Confirm the lost target and re-acquire it as necessary.
EXT. AIS	Something is wrong with the connected AIS unit (see section 12.5.5).	Check connection to AIS unit.
WTR TEMP	The water temperature is within the range set (see section 8.8),	-
WTR TEMP	The water temperature is higher or lower than the range set (see section 8.8).	-

APPX. 5 ALARM LIST

Title (indication in the information box)	Meaning	Remedy
CURRENT	The water temperature goes higher or lower than the preset value within the interval time set (see section 8.9).	-
DEPTH	The bottom echo is within the alarm range set (see section 8.10).	-
FISH SCH.	A fish echo is within the preset alarm range (see section 11.17.1).	-
BTM FISH	A fish echo is within a predetermined distance from the bottom (see section 11.17.2).	-
SNGL FSH	A fish of the specified length is in the alarm zone (see section 11.17.3).	-
BTM COMP	The bottom type (rock, gravel, sand, mud) matches both the bottom type and probability percentage selected (see section 11.17.4).	-

**SPECIFICATIONS OF COLOR GPS PLOTTER/SOUNDER
GP-3700F**

1 DISPLAY UNIT

- 1.1 Display system 12.1-inch IPS color LCD, 246 x 184.5 mm
- 1.2 Resolution 800 x 600 (SVGA)
- 1.3 Brilliance 400 cd/m² typical
- 1.4 Projection Mercator
- 1.5 Usable area 85° latitude or below
- 1.6 Display mode Plotter, Compass, Echo sounder, Satellite information, Tide graph

2 GPS RECEIVER

- 2.1 Receiving channels GPS: 12 channels, 12 satellite, parallel tracking
SBAS: 2 channels
QZSS: 2 channels
- 2.2 Rx frequency GPS: 1575.42 MHz
- 2.3 Rx code GPS/SBAS: L1C/A
- 2.4 Position accuracy GPS: 10 m approx., 95% of the time, 2 drms, HDOP<4, 2 drms
DGPS: 5 m approx., 95% of the time, 2 drms (optional kit required)
SBAS: 7 m approx., 95% of the time, 2 drms
- 2.5 Tracking velocity 999 kn
- 2.6 Position-fixing time 90 s approx.
- 2.7 Position update interval 1 s
- 2.8 Beacon receiver (internal kit, option)
 - Frequency range 283.5 to 325.0 kHz
 - Channel interval 500 Hz
 - Baudrate 50, 100, 200 bps
 - Channel selection Auto or manual

3 PLOTTER

- 3.1 Effective projection area 0.025 to 1,024 NM (at equatorial area)
- 3.2 Track display Plot interval: by time (1s to 99m 59s) or distance (0.01 to 9.99 NM)
- 3.3 Memory capacity 1,100,000 points (recording memory 1 block + storage 10 block)

	<u>Number of point for one block</u>	<u>Maximum display points</u>
Own ship's track:	30,000 pts	3,000 pts
Mark/ line:	30,000 pts	3,000 pts
Other ship's track		
-Friend ship:	10,000 pts	1,000 pts
-TT:	10,000 pts	1,000 pts
-AIS:	10,000 pts	1,000 pts
-GPS buoy:	10,000 pts	1,000 pts
Waypoint:	3,500 points with comment (QP 100 points)	
Route:	200 routes and 1 simple route with 100 points each	
- 3.4 Alarms Arrival and Anchor watch, Cross track error and border, Point approach, Ship's speed in/out, Trip distance,

Water temperature*, Water depth*, Tide*, AIS approach/ vanishing, External AIS, CPA/TCPA, Differential positioning suspended
*: external data required

- 3.5 Electronic chart Mapmedia
- 3.6 Information display Ship's position (L/L), Ship's speed, Track color/type, Date and Time, Waypoint position, Range and bearing to destination waypoint, Cursor intersection L/L position, Range and bearing to cursor intersection, Water temperature and depth (sensor data required)

4 SOUNDER

- 4.1 Transmit frequency 50/200 kHz
- 4.2 Transmission 600 Wrms or 1k Wrms
- 4.3 Display range 5/10/20/40/80/150/300/500 m, shift; 0 to 1200 m
- 4.4 Extension mode Marker zoom, Bottom zoom, Bottom rock, Bottom distinction
- 4.5 Auto mode Cruising/Fishing selected
- 4.6 Picture advance 6 steps

5 INTERFACE

- 5.1 Number of ports
 - IEC61162-1 (NMEA) 3 ports, NMEA0183 V1.5/2.0/3.0/4.1, 4800/38400 bps
 - LAN 1 port, Ethernet, 100Base-TX
 - USB 2 ports, USB2.0, Type-A (for control unit connection/ maintenance)
 - NMEA2000 1 port
 - External speaker 1 port, 5W/4 ohm (no use)
 - External video output 1 port, Analog VGA
 - Contact closure BK: 1 port, Event switch: 2 ports
- 5.2 Data sentences
 - Input ALR, BLV, CRQ, CUR, DBK, DBS, DBT, DPT, GGA, GLL, GNS, HDG, HDM, HDT, MSK, MTW, MWV, RMA, RMB, RMC, THS, TLL, TTM, VDM, VDR, VHW, VTG, VWR, VWT, XDR, ZDA
 - Output AAM, APB, BOD, BWC/BWR, DBT/DPT, DTM, GGA, GLL, GNS, GSA, GSV, GTD, HDG, HDT, MSK, MSS, MTW, MWV, RMA, RMB, RMC, RTE, THS, TLL, TTM, VHW, VTG, WPL, XTE, ZDA
- 5.3 Output proprietary sentences
 - PFEC drcmd, pidat
- 5.4 NMEA2000 PGN
 - Input 059392/904, 060928, 061184, 126208/464/720/996, 127237/250, 129038/039/040/041/538/793/794/798/809/810, 130577/816/817/818/819/820/821/827
 - Output 059392/904, 060928, 061184, 126208/464/720/992/993, 127258, 128267/275, 129025/026/029/033/283/284/285/538/539, 130822/823/827

6 POWER SUPPLY

12-24 VDC (10.8-31.2 V): 2.8-1.5 A (1 kWrms)

7 ENVIRONMENTAL CONDITIONS

- 7.1 Ambient temperature
- | | |
|--------------|----------------|
| Antenna unit | -25°C to +70°C |
| Display unit | -15°C to +55°C |
- 7.2 Relative humidity 93% or less (+40°C)
- 7.3 Degree of protection
- | | |
|----------------------|------|
| Antenna unit | IP56 |
| Display/control unit | IP22 |
- 7.4 Vibration IEC60945 Ed.4

8 UNIT COLOR

- 8.1 Antenna unit N9.5 (white)
- 8.2 Display unit N2.5

INDEX

A

- AC up mode angle9-19
- ACCU-FISH™ 11-20
- Active screen 1-9
- AIS
 - activated target..... 12-2
 - automatic activation 12-6
 - CPA/TCPA alarm 12-7
 - external AIS alarm..... 12-8
 - list..... 12-5
 - lost alarm..... 12-7
 - proximity alarm..... 12-6
 - recording track 12-3
 - showing/hiding track..... 12-3
 - sleeping target..... 12-2
 - symbol color 12-3
 - symbols 12-1
 - target data 12-4
 - track color..... 12-3
 - track line type 12-3
- Alarm list AP-17
- Alphanumeric data entry 1-10
- Anchor watch alarm 8-3
- Antenna height..... 9-17
- Arrival alarm..... 8-3
- A-scope display..... 11-5
- Audio alarm pattern..... 8-2
- Automatic echo sounder mode
 - gain 11-9
 - mode selection 11-8
 - range 11-8
- Autopilot selection..... 9-10

B

- Background color 9-2, 9-16
- Bearing mode..... 9-11
- Bearing offset..... 9-10
- Bearing sensor..... 9-10
- Border alarm 8-4
- Bottom discrimination..... 11-22
 - alarm 11-26
 - discription 11-23
 - display 11-5
- Bottom echoes 11-31
- Bottom level 11-27
- Bottom lock display 11-4
- Bottom zoom display..... 11-4
- Brilliance 1-4

C

- Character display 9-1
- Chart character size 9-2
- Chart icons 2-12
- Chart scale 2-6
- Chart type 9-4

- Clutter 11-14
- Color bar 11-28, 11-30
- Compass display..... 2-3
- Controls
 - Display unit..... 1-1
 - Trackball control unit RCU-030 1-3
- Course marker 9-12
- Course smoothing 9-19
- Current display 9-15
- Current vector
 - on own ship mark 9-15
 - other ship's track 3-4
 - own ship track 3-4
- Cursor
 - color 9-14
 - Configuration..... 2-10
 - operation 2-6
 - shape 9-14

D

- Data logger 10-13
- Datum 9-17
- DECCA 9-8
- Demo mode 1-14
- Depth alarm 8-8
- Depth calibration 11-28
- Depth contour 9-4
- Depth indication 11-28
- Depth sensor..... 9-10
- Destination
 - quick point..... 7-1
 - route 7-6
 - skip waypoint..... 7-7
 - stop navigation 7-8
 - waypoint..... 7-4
 - waypoint switching method 7-7
- Destination information 1-8
- DGPS
 - baud rate 9-18
 - beacon station..... 9-18
- DGPS/SBAS
 - alarm 9-18
 - position-fixing 9-17
- Disable satellite
 - GPS..... 9-17
 - QZSS 9-19
 - SBAS..... 9-19
- Display setting..... 1-5
- Display shifting 2-8
- Display skipping 1-7
- Display switching..... 1-5
- Display waypoint 9-2
- Drift average time..... 9-10
- Drift vector
 - own ship track 3-5

Drift vector on own ship mark..... 9-15
 Drift/Current vector display..... 9-15
 Dual frequency display..... 11-3

E

Echo offset..... 11-27
 Echo smoothing..... 11-28
 Echo sounder display colors..... 11-17
 Echo sounder hue..... 11-16
 Echo sounder range..... 11-29
 Ethernet setting..... 9-21
 Event switch..... 9-16

F

FA-30 setting..... 9-22
 False echo..... 11-34
 Fish alarm (bottom lock)..... 11-25
 Fish alarm (fish size)..... 11-26
 Fish alarm (normal)..... 11-24
 Fish alarm level..... 11-27
 Fish school echoes..... 11-32
 Free up angle..... 9-19
 Function keys..... 1-12
 Fuse replacement..... 13-2

G

GPS buoy list..... 3-18, 3-19
 GPS fix mode..... 9-17

H

Heading marker..... 9-12
 Heading offset..... 9-10

I

Icon list..... AP-12
 Interference rejection..... 11-13
 Internal memory
 automatic backup..... 10-10
 display..... 10-3
 erasing..... 10-5
 loading backup data..... 10-11
 manual backup..... 10-10
 playback..... 10-4
 recording..... 10-1
 Intrusion point alarm..... 8-5

K

Key beep..... 9-10
 Keyboard test..... 13-8

L

Land color..... 9-2
 Language..... 9-10
 Latitude/longitude
 display format..... 9-11
 grid..... 9-1
 offset..... 9-17
 Letter color..... 9-16
 Line
 editing..... 4-7
 entering..... 4-5
 erasing..... 4-6

 type..... 4-2
 Line monitor..... 9-26
 Loading data from other equipment..... 10-14
 Log (operation/alarm)..... 13-6
 LOP formula..... 9-8
 Loran A..... 9-6
 Loran C..... 9-6

M

Magnetic bearing offset..... 9-11
 Main menu overview..... 1-9
 Maintenance..... 13-1
 Manual echo sounder mode
 gain..... 11-11
 mode setting..... 11-9
 range..... 11-10
 shift..... 11-10

Mark

 color..... 4-1
 editing..... 4-7
 entering..... 4-3
 erasing..... 4-6
 filter..... 4-15
 fish type..... 4-3
 information..... 4-9
 list..... 4-11
 size..... 4-2

Marker zoom display..... 11-3

Measurement

 depth, time between locations..... 11-12
 range and bearing between two points... 2-9

Memory clear..... 13-9

Memory I/O test..... 13-7

Menu tree..... AP-1

Minute mark..... 11-30

Mix display..... 11-6

MOB operations..... 1-11

MOB position..... 9-15

N

NAV aids..... 9-2

NAV information

 box..... 2-2

 setting..... 1-8

NMEA

 depth offset..... 9-10

 device information..... 9-23

 PGN setting..... 9-23

 speed averaging..... 9-17

 speed offset..... 9-10

 time difference..... 9-17

 water temperature offset..... 9-10

Numeric data entry..... 1-10

O

Orientation mode..... 2-7

Other ship information..... 3-18

Other ship's symbol (showing/hiding)..... 3-4

Other ship's track

 color..... 3-10

INDEX

- erasing3-21
- line type3-11
- plotting intervals3-13
- showing/hiding3-4
- Output setting9-19
- Own ship information3-16
- Own ship mark size9-13
- Own ship track
 - color3-7
 - editing3-15
 - erasing3-13
 - line type3-11
 - plotting intervals3-12
 - plotting method3-12
 - recording3-5
 - showing/hiding3-1
- P**
- Password
 - cancel9-25
 - change9-24
 - setting9-24
- Past picture review11-18
- Peak hold display11-6
- Picture advance speed11-18
- Pitch offset9-11
- Place name display9-2
- Plotter display2-1
- Plotter/echo sounder display11-7
- Position data source9-16
- Position smoothing9-17
- Power on/off1-3
- R**
- Radar target position5-10
- Random KP11-27
- Range (plotter display)9-9
- Range and bearing mode9-12
- Remove excess coords9-1
- Roll offset9-11
- Route
 - creating using own ship position6-3
 - creating with existing waypoints6-1
 - creating with selected tracks6-4
 - deleting6-6
 - editing6-5
 - searching6-6
 - speed for TTG calculation6-7
- Route alarm8-4
- RTE sentence9-19
- S**
- Satellite display2-4
- SBASAP-14
- SBAS satellite selection9-18
- Screenshot10-12
- Seabed detection position11-28
- Shear alarm8-7
- Ship speed alarm8-5
- Ship's direction9-14
- Ship's length9-13
- Ship's width9-13
- Simple calculation of drift3-17
- Single frequency display11-2
- Sound speed11-28
- Speed averaging9-17
- Speed calibration11-28
- Speed sensor9-10
- Speed smoothing9-17
- T**
- Target number3-20
- Target smart track9-15
- Temperature calibration11-28
- Temperature graph11-28
- Test pattern13-9
- Time difference setting9-17
- Time differencesAP-13
- Time display format9-11
- Trackball
 - maintenance13-2
 - replacement13-2
 - sensitivity9-25
- Transmission11-27
- Transmission power11-27
- Transparency
 - information box9-16
 - NAV data9-15
- Trimming border line9-2
- Trip range alarm8-6
- Troubleshooting13-3
- TT track
 - changing color3-10
 - changing line type3-12
- TVG11-27
- U**
- Unit
 - depth9-11
 - range9-11
 - speed9-11
 - water temperature9-11
 - wind speed9-11
- Unit information13-5
- USB flash memory
 - automatic backup10-9
 - insert10-5
 - loading backup data10-11
 - manual backup10-10
 - playback10-7
 - recording10-6
 - remove10-6
 - transfer10-8
- V**
- Vector display length9-15
- Video pilot9-15
- W**
- Water temperature alarm8-6
- Water temperature sensor9-10

Waypoint	
editing.....	5-7
entering at cursor position.....	5-1
entering at own ship position.....	5-1
entering by Decca LOPs.....	5-6
entering by latitude/longitude position.....	5-2
entering by Loran A/C LOPs.....	5-5
entering by range and bearing.....	5-4
erasing.....	5-8
information.....	5-9, 9-13
mark size.....	5-10
searching.....	5-8
speed for TTG calculation.....	5-9
Waypoint name display.....	9-2
Waypoint status.....	9-13
Weak echoes erasing.....	11-14
White line.....	11-16
White marker.....	11-15
X	
XTE alarm.....	8-4
Z	
Zero line.....	11-30
Zero line rejection.....	11-28
Zoom marker.....	11-28

Declaration of Conformity

[GP-3700F]

Bulgarian (BG)	С настоящото Furuno Electric Co., Ltd. декларира, че гореспоменат тип радиосъоръжение е в съответствие с Директива 2014/53/ЕС, СИ 2017/1206. Цялостният текст на ЕС/УК декларацията за съответствие може да се намери на следния интернет адрес:
Spanish (ES)	Por la presente, Furuno Electric Co., Ltd. declara que el tipo de equipo radioeléctrico arriba mencionado es conforme con la Directiva 2014/53/UE, SI 2017/1206. El texto completo de la declaración de conformidad de la EU/UK está disponible en la siguiente dirección Internet:
Czech (CS)	Tímto Furuno Electric Co., Ltd. prohlašuje, že výše zmíněné typ rádiového zařízení je v souladu se směrnicí 2014/53/EU, SI 2017/1206. Úplné znění EU/SK prohlášení o shodě je k dispozici na této internetové adrese:
Danish (DA)	Hermed erklærer Furuno Electric Co., Ltd., at ovennævnte radioudstyr er i overensstemmelse med direktiv 2014/53/EU, SI 2017/1206. EU/UK-overensstemmelseserklæringens fulde tekst kan findes på følgende internetadresse:
German (DE)	Hiermit erkläre die Furuno Electric Co., Ltd., dass der oben genannte Funkanlagentyp der Richtlinie 2014/53/EU, SI 2017/1206 entspricht. Der vollständige Text der EU/UK-Konformitätserklärung ist unter der folgenden Internetadresse verfügbar:
Estonian (ET)	Käesolevaga deklareerib Furuno Electric Co., Ltd., et ülalmainitud raadioseadme tüüp vastab direktiivi 2014/53/EL, SI 2017/1206 nõuetele. EL/GB vastavusdeklaratsiooni täielik tekst on kättesaadav järgmisel internetiaadressil:
Greek (EL)	Με την παρούσα η Furuno Electric Co., Ltd., δηλώνει ότι ο προαναφερθέντας ραδιοεξοπλισμός πληροί την οδηγία 2014/53/ΕΕ, SI 2017/1206. Το πλήρες κείμενο της δήλωσης συμμόρφωσης ΕΕ/UK διατίθεται στην ακόλουθη ιστοσελίδα στο διαδίκτυο:
English (EN)	Hereby, Furuno Electric Co., Ltd. declares that the above-mentioned radio equipment type is in compliance with Directive 2014/53/EU, SI 2017/1206. The full text of the EU/UK declaration of conformity is available at the following internet address:
French (FR)	Le soussigné, Furuno Electric Co., Ltd., déclare que l'équipement radioélectrique du type mentionné ci-dessus est conforme à la directive 2014/53/UE, SI 2017/1206. Le texte complet de la déclaration UE/RU de conformité est disponible à l'adresse internet suivante:
Croatian (HR)	Furuno Electric Co., Ltd. ovime izjavljuje da je gore rečeno radijska oprema tipa u skladu s Direktivom 2014/53/EU, SI 2017/1206. Cjeloviti tekst EU/UK izjave o sukladnosti dostupan je na sljedećoj internetskoj adresi:
Italian (IT)	Il fabbricante, Furuno Electric Co., Ltd., dichiara che il tipo di apparecchiatura radio menzionato sopra è conforme alla direttiva 2014/53/UE, SI 2017/1206. Il testo completo della dichiarazione di conformità UE/RU è disponibile al seguente indirizzo Internet:
Latvian (LV)	Ar šo Furuno Electric Co., Ltd. deklarē, ka augstāk minēts radioiekārta atbilst Direktīvai 2014/53/ES, SI 2017/1206. Pilns ES/AK atbilstības deklarācijas teksts ir pieejams šādā interneta vietnē:
Lithuanian (LT)	Aš, Furuno Electric Co., Ltd., patvirtinu, kad pirmiau minėta radijo įrenginių tipas atitinka Direktyvą 2014/53/ES, SI 2017/1206. Visas ES/JK atitikties deklaracijos tekstas prieinamas šiuo interneto adresu:
Hungarian (HU)	Furuno Electric Co., Ltd. igazolja, hogy fent említett típusú rádióberendezés megfelel a 2014/53/EU, SI 2017/1206 irányszabványnak. Az EU/EK-megfelelőségi nyilatkozat teljes szövege elérhető a következő internetes címen:
Maltese (MT)	B'dan, Furuno Electric Co., Ltd., niddikjara li msemmija hawn fuq-tip ta' tagħmir tar-radju huwa konformi mad-Direttiva 2014/53/UE, SI 2017/1206. It-test kollu tad-dikjarazzjoni ta' konformità tal-UE/RU huwa disponibbli f'dan l-indirizz tal-Internet li ġej:
Dutch (NL)	Hierbij verklaar ik, Furuno Electric Co., Ltd., dat het hierboven genoemde type radioapparatuur conform is met Richtlijn 2014/53/EU, SI 2017/1206. De volledige tekst van de EU/VK-conformiteitsverklaring kan worden geraadpleegd op het volgende internetadres:
Polish (PL)	Furuno Electric Co., Ltd. niniejszym oświadcza, że wyżej wymieniony typ urządzenia radiowego jest zgodny z dyrektywą 2014/53/UE, SI 2017/1206. Pełny tekst deklaracji zgodności UE/UK jest dostępny pod następującym adresem internetowym:
Portuguese (PT)	O(a) abaixo assinado(a) Furuno Electric Co., Ltd. declara que o mencionado acima tipo de equipamento de rádio está em conformidade com a Diretiva 2014/53/UE, SI 2017/1206. O texto integral da declaração de conformidade da EU/UK está disponível no seguinte endereço de Internet:
Romanian (RO)	Prin prezenta, Furuno Electric Co., Ltd. declară că echipamentul radio menționat mai sus este în conformitate cu Directiva 2014/53/UE, SI 2017/1206. Textul integral al declarației de conformitate UE/RU este disponibil la următoarea adresă internet:
Slovak (SK)	Furuno Electric Co., Ltd. týmto vyhlasuje, že vyššie spomínané rádiové zariadenie typu je v súlade so smernicou 2014/53/EÚ, SI 2017/1206. Úplné EÚ/SK vyhlásenie o zhode je k dispozícii na tejto internetovej adrese:
Slovenian (SL)	Furuno Electric Co., Ltd. potrjuje, da je zgoraj omenjeno tip radijske opreme skladen z Direktivo 2014/53/EU, SI 2017/1206. Celotno besedilo izjave EU/ZK o skladnosti je na voljo na naslednjem spletnem naslovu:
Finnish (FI)	Furuno Electric Co., Ltd. vakuuttaa, että yllä mainittu radiolaitetyyppi on direktiivin 2014/53/EU, SI 2017/1206 mukainen. EU/UK-vaatimustenmukaisuusvakuutuksen täysimittainen teksti on saatavilla seuraavassa internetosoitteessa:
Swedish (SV)	Härmed försäkrar Furuno Electric Co., Ltd. att ovan nämnda typ av radioutrustning överensstämmer med direktiv 2014/53/EU, SI 2017/1206. Den fullständiga texten till EU/Storbritannien-försäkran om överensstämmelse finns på följande webbadress:

Online Resource

http://www.furuno.com/en/support/red_doc

Notice for radiated immunity

The test for the radiated immunity is performed up to 2.7 GHz only without the special condition of spot frequency being applied. There is a chance that this equipment may interfere with allocated services in the frequency range of 2.7 GHz to 6 GHz, particularly in harbors, rivers, lake banks, etc.