

GARMIN®

GPSMAP®

8400/8600/8700 SERIES



**Owner's
Manual**

Table of Contents

Introduction..... 13

Protective Cover.....	13
Device Overview.....	13
Using the Touchscreen.....	13
On-Screen Buttons.....	14
Locking and Unlocking the Touchscreen.....	14
Connector View (8x10, 8x12, and 8x16 models).....	14
Connector View (8x17, 8x22, and 8x24 models).....	15
Connector View (8700 models).....	16
Tips and Shortcuts (MFD models).....	16
Tips and Shortcuts (Black Box models).....	17
Accessing Owner's Manuals on the Chartplotter.....	17
Accessing the Manuals from the Web.....	18
Garmin® Support Center.....	18
Memory Cards.....	18
Inserting Memory Cards (GPSMAP® 8x10/8x12/8x16).....	18
Inserting a Memory Card (GPSMAP® 8x17/8x22/8x24/87xx).....	19
Acquiring GPS Satellite Signals.....	20
Selecting the GPS Source.....	20

Customizing the Chartplotter..... 21

Home Screen.....	21
Pinning a Feature Button.....	22
Rearranging the Category Items.....	22
Menu Bar.....	22
Hiding and Showing the Menu Bar..	23
Setting the Vessel Type.....	23
Adjusting the Backlight.....	23
Adjusting the Color Mode.....	23
Adjusting the Color Theme.....	23
Enabling Screen Lock.....	23
Turning On the Chartplotter Automatically.....	23
Automatically Turning Off the System.....	24
Customizing Pages.....	24
Creating a New Combination Page..	24

Adding a SmartMode™ Layout.....	24
Customizing the Layout of a SmartMode™ or Combination Page.....	24
Deleting a Combination Page.....	25
Customizing the Data Overlays.....	25
Resetting the Station Layouts.....	25
Customizing the Startup Screen.....	25
Presets.....	26
Managing Presets.....	26
Saving a New Preset.....	26

Controlling the Chartplotter..... 27

Voice Control.....	27
Changing the Voice Control Language on a Garmin® Chartplotter.....	27
Supported Headsets.....	27
Pairing a Wireless Headset with a Garmin® Chartplotter.....	27
Using a Wireless Headset with a Garmin® Chartplotter.....	27
Pairing a Garmin® Watch with a Garmin Chartplotter for Voice Control.....	27
Using a Garmin® Watch with a Garmin Chartplotter for Voice Control.....	28
Chartplotter Voice Commands.....	28
GRID™ Remote Control.....	32
Pairing the GRID™ Device with the Chartplotter from the Chartplotter... 32	
Pairing the GRID™ Device with the Chartplotter from the GRID Device..	32
Pairing the GRID™ 20 Device with the Chartplotter from the GRID 20 Device.....	32
Rotating the GRID™ Remote Input Device.....	32

ActiveCaptain® App..... 33

ActiveCaptain® and Garmin BlueNet™ Considerations.....	33
ActiveCaptain® Roles.....	33
Getting Started with the ActiveCaptain® App.....	33
Enabling Smart Notifications.....	34
Receiving Notifications.....	34

Managing Notifications.....	35
Making Notifications Private.....	35
Updating Software with the ActiveCaptain® App.....	35
Updating Charts with ActiveCaptain® ..	36
Chart Subscriptions.....	36

Communication with Wireless Devices..... 37

Wi-Fi® Network.....	37
Setting Up the Wi-Fi® Network.....	37
Connecting a Wireless Device to the Chartplotter.....	37
Changing the Wireless Channel.....	37
Changing the Wi-Fi® Host.....	37
Wireless Remote Control.....	37
Pairing the Wireless Remote Control With the Chartplotter.....	37
Turning On and Off the Remote Backlight.....	37
Disconnecting the Remote Control from All Chartplotters.....	38
Pairing a Garmin® Watch to Control a Garmin Chartplotter.....	38
Wireless Wind Sensor.....	38
Connecting a Wireless Sensor to the Chartplotter.....	38
Adjusting the Wind Sensor Orientation.....	38
Viewing Boat Data on a Garmin® Watch.....	38

Charts and 3D Chart Views..... 40

Detailed Charts.....	40
Activating a Marine Chart Subscription.....	40
Purchasing a Chart Subscription with ActiveCaptain®	40
Renewing Your Subscription.....	41
Navigation Chart and Fishing Chart....	41
Chart Symbols.....	41
Zooming In and Out Using the Touchscreen.....	41
Measuring a Distance on the Chart.....	41
Creating a Waypoint on the Chart... ..	42

Viewing Location and Object Information on a Chart.....	42
Viewing Details about Navaids.....	42
Navigating to a Point on the Chart..	42
Premium Chart Features.....	42
Fish Eye 3D Chart View.....	43
Viewing Tide Station Information....	43
Showing Satellite Imagery on the Navigation Chart.....	44
Viewing Aerial Photos of Landmarks.....	44
Automatic Identification System.....	45
AIS Targeting Symbols.....	45
Heading and Projected Course of Activated AIS Targets.....	46
Viewing a List of AIS Threats.....	46
Activating a Target for an AIS Vessel.....	46
Setting the Safe-Zone Collision Alarm.....	47
AIS Aids to Navigation.....	47
Turning Off AIS Reception.....	48
Chart Menu.....	49
Chart Layers.....	49
Chart Settings.....	52
Fish Eye 3D Settings.....	52
Supported Maps.....	53

Garmin Quickdraw™ Contours Mapping..... 54

Mapping a Body of Water Using the Garmin Quickdraw™ Contours Feature.....	54
Adding a Label to a Garmin Quickdraw™ Contours Map.....	54
Garmin Quickdraw™ Community.....	54
Connecting to the Garmin Quickdraw™ Community with ActiveCaptain®	55
Garmin Quickdraw™ Contours Settings.....	55

Navigation with a Chartplotter..... 56

Basic Navigation Questions.....	56
Route Color Coding.....	57
Destinations.....	57
Searching for a Destination by Name.....	57

Selecting a Destination Using the Navigation Chart.....	57	Tracks.....	64
Searching for a Marine Services Destination.....	57	Showing Tracks.....	64
Setting and Following a Direct Course Using Go To.....	57	Setting the Color of the Active Track.....	64
Stopping Navigation.....	58	Saving the Active Track.....	64
Waypoints.....	58	Viewing a List of Saved Tracks.....	64
Marking Your Present Location as a Waypoint.....	58	Editing a Saved Track.....	64
Creating a Waypoint at a Different Location.....	58	Saving a Track as a Route.....	65
Marking a Man Overboard or Other SOS Location.....	58	Browsing for and Navigating a Recorded Track.....	65
Projecting a Waypoint.....	58	Deleting a Saved Track.....	65
Viewing a List of all Waypoints.....	59	Deleting All Saved Tracks.....	65
Editing a Saved Waypoint.....	59	Retracing the Active Track.....	65
Moving a Saved Waypoint.....	59	Clearing the Active Track.....	65
Browsing for and Navigating to a Saved Waypoint.....	59	Managing the Track Log Memory During Recording.....	65
Deleting a Waypoint or an MOB.....	60	Configuring the Recording Interval of the Track Log.....	65
Deleting All Waypoints.....	60	Boundaries.....	66
Routes.....	60	Creating a Boundary.....	66
Creating and Navigating a Route From Your Present Location.....	60	Converting a Route to a Boundary... ..	66
Creating and Saving a Route.....	60	Converting a Track to a Boundary... ..	66
Viewing a List of Routes and Auto Guidance Paths.....	60	Editing a Boundary.....	66
Editing a Saved Route.....	60	Linking a Boundary to a SmartMode™ Layout.....	66
Finding and Navigating a Saved Route.....	61	Setting a Boundary Alarm.....	67
Browsing for and Navigating Parallel to a Saved Route.....	61	Disabling all Boundary Alarms.....	67
Initiating a Search Pattern.....	62	Deleting a Boundary.....	67
Deleting a Saved Route.....	62	Deleting All Saved Waypoints, Tracks, Routes, and Boundaries.....	67
Deleting All Saved Routes.....	62	Sailing Features.....	68
Auto Guidance.....	62	Setting the Vessel Type for Sailing Features.....	68
Setting and Following an Auto Guidance Path.....	62	Sail Racing.....	68
Creating and Saving an Auto Guidance Path.....	62	Starting Line Guidance.....	68
Adjusting a Saved Auto Guidance Path.....	63	Starting the Race Timer.....	69
Canceling an Auto Guidance Calculation in Progress.....	63	Stopping the Race Timer.....	69
Setting a Timed Arrival.....	63	Setting the Distance between the Bow and the GPS Antenna.....	69
Auto Guidance Path Configurations.....	63	Sailing Navigation Chart Presets.....	70
		SmartMode™ Layouts for Sailing.....	70
		Laylines Settings.....	70
		Polar Tables.....	70
		Selecting a Preloaded Polar Table..	71
		Viewing Polar Table Details.....	71
		Showing Polar Data in Data Fields..	71

Adjusting the Scale of the Polar Table.....	72
Turning Off Polar Table Data.....	72
Steer Assist.....	72
Setting the Keel Offset.....	73
Sailboat Autopilot Operation.....	74
Wind Hold.....	74
Tack and Gybe.....	75
Heading Line and Angle Markers.....	76
Setting the Heading Line and Angle Markers.....	76
Viewing Sailing Vessel Data.....	76

Sonar Fishfinder..... 77

Stopping the Transmission of Sonar Signals.....	77
Traditional Sonar View.....	77
Split-Frequency Sonar View.....	77
Garmin ClearVü™ Sonar View.....	77
Garmin SideVü™ Sonar View.....	78
SideVü Scanning Technology.....	79
Measuring Distance on the Sonar Screen.....	79
Panoptix™ Sonar Views.....	80
LiveVü Down Sonar View.....	80
LiveVü Forward Sonar View.....	80
RealVü 3D Forward Sonar View.....	81
RealVü 3D Down Sonar View.....	82
RealVü 3D Historical Sonar View....	82
Garmin FrontVü™ Sonar View.....	84
Triple Beam Sonar View.....	84
LiveScope™ Sonar View.....	84
Zooming in a Panoptix™ LiveVü or LiveScope™ Sonar View.....	85
Perspective View.....	85
OneVü™ Scanning Sonar.....	86
Starting and Stopping OneVü™ Scanning.....	86
Interacting with the OneVü™ Sonar View.....	86
Changing Between 2D and 3D Views.....	86
OneVü™ Sonar Options.....	87
Sonar Views in Combo Screens.....	87
Selecting the Transducer Type.....	88
Selecting a Sonar Source.....	88
Renaming a Sonar Source.....	88

Sonar Sharing.....	88
Synchronizing Sonar Scroll Rates...	89
Pausing and Resuming the Sonar Display.....	89
Paused Sonar Considerations.....	89
Viewing Sonar History.....	89
Creating a Waypoint on the Sonar Screen.....	90
Adjusting the Level of Detail.....	90
Adjusting the Color Intensity.....	90
Sonar Setup.....	90
Setting the Zoom Level on the Sonar Screen.....	91
Setting the Scroll Speed.....	91
Adjusting the Range.....	91
Sonar Noise Rejection Settings.....	92
Sonar Appearance Settings.....	92
Sonar Alarms.....	93
Advanced Sonar Settings.....	93
Transducer Installation Settings.....	94
Sonar Frequencies.....	94
Turning On the A-Scope.....	95
Heave Compensation.....	96
Panoptix™ Sonar Setup.....	96
Adjusting the RealVü Viewing Angle and Zoom Level.....	96
Adjusting the RealVü Sweep Speed.....	97
LiveVü Forward and Garmin FrontVü™ Sonar Settings.....	97
RealVü Appearance Settings.....	98
Panoptix™ Transducer Installation Settings.....	98
LiveScope and Perspective Sonar Settings.....	100
LiveScope and Perspective Sonar Setup.....	100
LiveScope and Perspective Appearance Settings.....	100
LiveScope and Perspective Layout Settings.....	101
LiveScope and Perspective Transducer Installation Settings...	101

Spy Pole Control..... 102

Connecting a Spy Pole to a Garmin® Chartplotter.....	102
--	-----

Adding the Spy Pole Controls to Screens.....	102
Spy Pole Control Bar.....	102
Pairing with a Force® Trolling Motor..	103
SpyLink™ Synchronization.....	103
SpyLink™ Feature Requirements....	103
SpyLock™ Feature.....	103
SpyLock™ Feature Requirements...	103
Setting a SpyLock™ Point on a Chart or Sonar View.....	104
SpyScan™ Search Mode.....	104
Spy Pole Options and Settings.....	104
Configuring a Spy Pole.....	105
Pairing Spy Pole Accessories.....	106

Radar..... 108

Radar Interpretation.....	108
Radar Overlay.....	108
Radar Overlay and Chart Data Alignment.....	108
Transmitting Radar Signals.....	109
Stopping the Transmission of Radar Signals.....	109
Setting Up the Timed Transmit Mode.....	109
Enabling and Adjusting a Radar No Transmit Zone.....	109
Adjusting the Radar Range.....	109
Tips for Selecting a Radar Range..	109
MotionScope™ Doppler Radar Technology.....	110
Enabling Guard Zones.....	110
Defining a Circular Guard Zone.....	110
Defining a Partial Guard Zone.....	111
MARPA.....	111
MARPA Targeting Symbols.....	111
Acquiring MARPA Targets Automatically.....	112
Removing MARPA Targets Automatically.....	112
Assigning a MARPA Tag to an Object.....	112
Removing a MARPA Tag from a Targeted Object.....	112
Viewing Information about a MARPA-tagged Object.....	112
Viewing a List of AIS Threats.....	112

Showing AIS Vessels on the Radar Screen.....	112
Combining the Same MARPA and AIS Target.....	112
MARPA Dangerous Target Alarm Settings.....	113
VRM and EBL.....	113
Echo Trails.....	114
Turning on Echo Trails.....	114
Adjusting the Length of the Echo Trails.....	114
Clearing the Echo Trails.....	114
Radar Settings.....	114
Radar Gain.....	114
Radar Filter Settings.....	115
Radar Options Menu.....	116
Radar Setup Menu.....	116
Radar Appearance Settings.....	116
Radar Installation Settings.....	117
Radar My Vessel Layer Settings....	117
Radar Overlay Chart Settings.....	117
Selecting a Different Radar Source...	117

Autopilot..... 118

Autopilot Configuration.....	118
Selecting the Preferred Heading Source.....	118
Opening the Autopilot Screen.....	118
Autopilot Screen.....	119
Adjusting the Step Steering Increment.....	119
Setting the Power Saver.....	119
Enabling the Shadow Drive™ Feature.....	119
Autopilot Overlay Bar.....	120
Engaging the Autopilot.....	120
Adjusting the Heading Using the Helm.....	120
Adjusting the Heading with the Chartplotter in Step Steering Mode.....	120
Autopilot Navigation.....	121
Steering Patterns.....	121
Following the U-Turn Pattern.....	121
Setting Up and Following the Circles Pattern.....	121
Setting Up and Following the Zigzag Pattern.....	121

Following the Williamson Turn Pattern.....	121
Following an Orbit Pattern.....	121
Setting Up and Following the Cloverleaf Pattern.....	122
Setting Up and Following a Search Pattern.....	122
Cancelling a Steering Pattern.....	122
Adjusting the Autopilot Response....	122
Enabling Auto Response.....	122
Low-Speed Autopilot Mode.....	122
Enabling and Disabling Low-Speed Autopilot Mode.....	122
Engaging and Disengaging Low Speed Autopilot Mode.....	123
Enabling the Autopilot Controls on a Garmin® Watch.....	123
Customizing the Autopilot Button Actions.....	123
Controlling the Autopilot with a GRID™ 20 Remote Control.....	123
Reactor™ Autopilot Remote Control..	123
Pairing a Reactor™ Autopilot Remote Control With a Chartplotter.....	124
Changing the Functions of the Reactor™ Autopilot Remote Control Action Keys.....	124
Updating the Reactor™ Autopilot Remote Control Software.....	124
Autopilot Keypad.....	124
Function Key Default Actions.....	124
Configuring the Function Keys.....	124
Power Steering Mode.....	125
Enabling Power Steering Mode.....	125
Yamaha® Autopilot.....	125
Yamaha® Autopilot Screen.....	126
Yamaha® Autopilot Overlay Bar.....	126

Force® Trolling Motor Control..... 128

Connecting to a Trolling Motor.....	128
Adding the Trolling Motor Controls to Screens.....	128
Trolling Motor Control Bar.....	128
Reverse Thrust.....	129
Trolling Motor Settings.....	129

Assigning a Shortcut to the Trolling Motor Remote Control Shortcut Keys.....	130
Calibrating the Trolling Motor Compass.....	130
Setting the Bow Offset.....	130
Calibrating the Steering Alignment	130

Digital Selective Calling..... 132

Networked Chartplotter and VHF Radio Functionality.....	132
Turning On DSC.....	132
DSC List.....	132
Viewing the DSC List.....	132
Adding a DSC Contact.....	132
Incoming Distress Calls.....	132
Navigating to a Vessel in Distress.	132
Man-Overboard Distress Calls Initiated from a VHF Radio.....	133
Man-Overboard and SOS Distress Calls Initiated from the Chartplotter.....	133
Position Tracking.....	133
Viewing a Position Report.....	133
Navigating to a Tracked Vessel....	133
Creating a Waypoint at the Position of a Tracked Vessel.....	133
Editing Information in a Position Report.....	133
Deleting a Position-Report Call....	134
Viewing Vessel Trails on the Chart	134
Individual Routine Calls.....	134
Selecting a DSC Channel.....	134
Making an Individual Routine Call..	134
Making an Individual Routine Call to an AIS Target.....	134

Gauges and Graphs..... 136

Viewing the Gauges.....	136
Engine Alert Icons.....	136
Changing the Data Shown in a Gauge.....	136
Customizing the Gauges.....	136
Customizing Engine Gauge and Fuel Gauge Limits.....	137
Selecting the Number of Engines Shown in Gauges.....	137

- Customizing the Engines Shown in Gauges..... 137
- Enabling Status Alarms for Engine Gauges..... 137
- Enabling Some Engine Gauge Status Alarms..... 137
- Yamaha® Engine and Motor Gauges.. 137
 - Engine and Motor Function Icons.. 138
 - Engine and Motor Status Icons..... 139
 - Engine and Motor Warning Icons.. 139
 - Setting Up the Gauges..... 139
- Mercury® Engine Gauges..... 140
- Setting the Fuel Alarm..... 141
 - Synchronizing the Fuel Data with the Actual Vessel Fuel..... 141
- Viewing the Wind Gauges..... 142
 - Configuring the Sailing Wind Gauge..... 142
 - Configuring the Speed Source..... 142
 - Configuring the Heading Source of the Wind Gauge..... 142
 - Customizing the Close-Hauled Wind Gauge..... 142
- Viewing Trip Gauges..... 143
 - Resetting Trip Gauges..... 143
- Viewing Graphs..... 143
 - Setting the Graph Range and Time Scales..... 143
 - Disabling Graph Filtering..... 143

Garmin OnBoard™ Man Overboard Engine Cutoff System..... 144

- MOB Tag..... 144
 - Attaching the Band or Carabiner Loop..... 144
 - MOB Tag Roles..... 145
 - Turning an MOB Tag On and Off... 146
 - Checking the Status of an MOB Tag..... 146
 - Disarming an MOB Tag..... 146
 - Initiating an MOB Procedure from an MOB Tag Manually..... 147
 - Replacing the MOB Tag Battery.... 147
- Configuration..... 147
 - Adding the MOB Tags Overlay..... 148
 - Pairing an MOB Tag..... 148
 - Changing the Role of an MOB Tag. 149

- Changing the Name of an MOB Tag..... 149
- Changing the Reacquisition Time for an MOB Tag..... 149
- Removing an MOB Tag..... 149
- Restoring the Garmin OnBoard™ Engine Cutoff System to Factory Default Settings..... 149
- Restoring an MOB Tag to Factory Default Settings..... 149
- System Bypass..... 150
 - Bypassing the System From a Chartplotter..... 150
 - Bypassing the System from the GOS™ 10 Hub..... 150

inReach® Messages..... 152

- Connecting an inReach® Device to the Chartplotter..... 152
- Receiving Messages..... 152
- Replying to a Message..... 152
- Sending a Check-In Message..... 153
- Starting a New Conversation..... 153
- Sending a Quick Message..... 153
- Sending a Custom Message..... 153
- inReach® SOS Calls..... 153
 - Sending an inReach® SOS Call..... 154
 - Communicating with the Garmin Response™ Team During an SOS Call..... 154
 - Cancelling an inReach® SOS Call... 154
- Changing inReach® Tracking Settings..... 154

Digital Switching..... 155

- Adding and Editing a Digital Switching Page..... 155
- Garmin Boat Switch™ 155
 - Configuring the Garmin Boat Switch™ Device..... 155
 - Using the Bilge Pump Switches.... 156
 - Using Dimmable Lights..... 156
 - Configuring Digital Switches for Voice Control..... 156

Controlling Third-Party Equipment Installed on Your Boat..... 158

Power-Pole® Anchor System.....	158
Enabling the Power-Pole® Anchor or CHARGE™ Overlay.....	158
Setting Up the Power-Pole® Anchor.....	158
Power-Pole® Overlay.....	158
Power-Pole® Advanced Boat Control.....	159
CHARGE™ Overlay.....	159
Enabling the Mercury® Helm.....	160
Mercury® Troll Control Features.....	160
Adding the Mercury® Troll Control Overlay.....	160
Mercury® Troll Overlay.....	160
Mercury® Cruise Control.....	161
Enabling the Mercury® Cruise Control Overlay.....	161
Mercury® Cruise Control Overlay...	161
Mercury® Engine Details.....	161
Adding the Mercury® Engine Overlay.....	161
Mercury® Engine Overlay.....	161
Enabling the Mercury® Engine Sport Exhaust Setting.....	162
Mercury® Active Trim Control.....	162
Adding the Mercury® Active Trim Overlay.....	162
Mercury® Active Trim Overlay.....	162
Skyhook® Digital Anchor Control.....	163
Adding the Skyhook® Digital Anchor Control Overlay.....	163
Original Skyhook Digital Anchor Overlay.....	163
Skyhook Digital Anchor 2.0 Overlay.....	163
Dometic® Optimus® Features.....	164
Activating the Optimus® Overlay Bar.....	164
Optimus® Overlay Bar Overview.....	164
Optimus® Overlay Symbols.....	164
Optimus® Limp Home Mode.....	165

Tide, Current, and Celestial Information..... 166

Tide and Current Overlays.....	166
Adding Tide and Current Overlays.	166
Tide Station Information.....	166
Current Station Information.....	166
Celestial Information.....	167
Viewing Tide Station, Current Station, or Celestial Information for a Different Date.....	167
Viewing Information for a Different Tide or Current Station.....	167
Viewing Almanac Information from the Navigation Chart.....	167

Messages and Warnings..... 168

Viewing Messages and Warnings.....	168
Sorting and Filtering Messages.....	168
Saving Messages to a Memory Card	168
Clearing all Messages and Warnings	168

Media Player..... 169

Opening the Media Player.....	169
Media Player Icons.....	169
Selecting the Media Device and Source.....	169
Adjusting the Volume and Audio Levels.....	169
Adjusting the Volume.....	169
Adjusting the Audio Level.....	169
Muting the Media Volume.....	170
Automatic Volume Adjustment Based on Speed.....	170
Stereo Zones and Groups.....	171
Selecting the Home Zone.....	171
Adjusting the Zone Volume.....	171
Disabling a Speaker Zone.....	171
Creating a Group.....	171
Playing Music.....	172
Browsing for Music.....	172
Setting a Song to Repeat.....	173
Setting All Songs to Repeat.....	173
Setting Songs to Shuffle.....	173
Radio.....	173
Setting the Tuner Region.....	173
Changing the Radio Station.....	173
Changing the Tuning Mode.....	173

Presets.....	173
DAB Playback.....	174
Setting the DAB Tuner Region.....	174
Scanning for DAB Stations.....	174
Changing DAB Stations.....	174
DAB Presets.....	174
SiriusXM® Satellite Radio.....	175
Locating a SiriusXM® Radio ID.....	175
Activating a SiriusXM®	
Subscription.....	175
Customizing the Channel Guide....	175
Saving a SiriusXM® Channel to the	
Presets List.....	175
Parental Controls.....	175
Setting the Device Name.....	176
Updating the Media Player Software.	176
Audio Return Channel.....	176

Configuring a Stereo from the Chartplotter..... 177

SiriusXM® Weather..... 178

SiriusXM® Equipment and Subscription	
Requirements.....	178
Weather Data Broadcasts.....	178
Weather Warnings and Weather	
Bulletins.....	178
Viewing Precipitation Information....	178
Storm Cell and Lightning	
Information.....	178
Hurricane Information.....	179
Forecast Information.....	179
Viewing a Marine Forecast or an	
Offshore Forecast.....	179
Viewing Forecast Information for	
Another Time Period.....	179
Weather Fronts and Pressure	
Centers.....	179
City Forecasts.....	179
Viewing Fish Mapping Data.....	180
Viewing Sea Conditions.....	180
Surface Winds.....	180
Wave Height, Wave Period, and Wave	
Direction.....	180
Viewing Forecast Sea Conditions	
Information for Another Time	
Period.....	180

Viewing Sea Temperature	
Information.....	180
Surface Pressure and Water	
Temperature Data.....	180
Changing the Sea Surface	
Temperature Color Range.....	181
Visibility Information.....	181
Viewing Forecast Visibility Information	
for Another Time Period.....	181
Viewing Buoy Reports.....	181
Viewing Local Weather Information	
near a Buoy.....	181
Weather Overlay.....	181
Viewing Weather Subscription	
Information.....	182

Viewing Video..... 183

Video Source Considerations.....	183
Video Source Types.....	183
Changing the Video Source Name and	
Type.....	183
Networked Video Devices.....	184
Using Video Presets on Networked	
Video Cameras.....	184
Camera Settings.....	184
Video Settings.....	185
Video Camera Movement Control.	185
Configuring the Video Appearance... 185	
Changing the Camera View.....	186
Mirroring or Rotating the Camera	
Image.....	186
Configuring Guidance Lines.....	186
Alternating Among Multiple Camera	
Sources.....	187
Camera Tracking.....	187
Setting the Camera Angle and	
Height.....	187
Using Compass Lock.....	187
Using Vessel Lock.....	188
HDMI® Video Considerations.....	188
Controlling HDMI® Audio.....	189
Pairing the GC™ 100 Camera with a	
Garmin® Chartplotter.....	189

Surround View Camera System..... 190

Changing a Camera.....	190
Viewing a Camera Feed Full Screen..	190

Changing the Surround View Camera System Layout.....	191
Showing and Hiding the Visual Bumper.....	191
Adjusting the Visual Bumper.....	191
Showing the Distance Marker.....	191
Surround View Camera Movement Control.....	191
Renaming a Camera.....	191
Setting the Camera to Mirrored Stern View.....	191
Object Detection and Proximity Alert	191
Enabling the Proximity Beeper.....	192
Proximity Beeper Mute Behavior...	193

LED Lighting Control..... 194

LED Light Controller Configuration...	194
Initializing Connected LED Lights..	194
Renaming an LED Light.....	194
Associating LED Lights with an Audio Zone.....	195
Renaming an LED Lighting Controller.....	195
Removing an LED Lighting Controller.....	195
LED Lighting Control Screen.....	195
Turning LED Lights On and Off.....	196
Adjusting LED Light Brightness.....	196
Changing LED Light Color.....	196
Changing LED Light Effects.....	196
Setting LED Lights to React to Music.....	197
LED Light Scenes.....	197
Creating a new LED Light Scene...	197
Editing an LED Light Scene.....	197
Starting an LED Light Scene.....	198
Deleting an LED Light Scene.....	198
LED Light Groups.....	198
Creating and Adding Lights to an LED Light Group.....	198
Editing an LED Light Group.....	198
Renaming an LED Light Group.....	199

Device Configuration..... 200

System Settings.....	200
Sounds and Display Settings.....	200
Satellite Positioning (GPS) Settings.....	200

Station Settings.....	201
Viewing System Software Information.....	201
Viewing E-label Regulatory and Compliance Information.....	201
Preferences Settings.....	201
Units Settings.....	202
Navigation Settings.....	202
Communications Settings.....	203
Viewing Connected Devices.....	203
NMEA® 0183 Settings.....	203
NMEA 2000® Settings.....	204
The Garmin BlueNet™ Network and the Legacy Garmin® Marine Network...	204
Setting Alarms.....	205
Navigation Alarms.....	205
System Alarms.....	205
Sonar Alarms.....	205
Setting Weather Alarms.....	206
Setting the Fuel Alarm.....	206
My Vessel Settings.....	206
Setting the Keel Offset.....	207
Setting the Water Temperature Offset.....	207
Fuel Settings.....	208
Calibrating a Water-Speed Device.	208
Other Vessels Settings.....	208
Settings that are Synced on the Garmin® Marine Network.....	209
Restoring the Original Chartplotter Factory Settings.....	209

Sharing and Managing User Data.. 211

Selecting a File Type for Third-Party Waypoints and Routes.....	211
Copying User Data from a Memory Card.....	211
Copying All User Data to a Memory Card.....	211
Copying User Data from a Specified Area to a Memory Card.....	211
Updating Built-In Maps with a Memory Card and Garmin Express™	212
Backing Up Data to a Computer.....	212
Restoring Backup Data to a Chartplotter.....	212

Saving System Information to a Memory Card.....	212
---	-----

Appendix..... 213

Device Care.....	213
Cleaning the Screen.....	213
ActiveCaptain® and Garmin Express™	213
Garmin Express™ App.....	213
Installing the Garmin Express™ App on a Computer.....	214
Registering Your Device Using the Garmin Express™ App.....	214
Updating Your Charts Using the Garmin Express™ App.....	214
Software Updates.....	215
NMEA® 0183 with Audio Cable.....	216
Touchscreen Controls for a Connected Computer (GPSMAP® 8x10/8x12/8x16).....	216
Touchscreen Controls for a Connected Computer (GPSMAP® 9500 Black Box).....	217
Controlling a Computer with the Chartplotter.....	218
Viewing Images on a Memory card...	218
Screenshots.....	218
Capturing Screenshots.....	218
Copying Screenshots to a Computer.....	218
Troubleshooting.....	219
My device will not acquire GPS signals.....	219
My device will not turn on or keeps turning off.....	219
My device is not creating waypoints in the correct location.....	219
Specifications.....	220
GPSMAP® 8x10 Specifications.....	220
GPSMAP® 8x12 Specifications.....	220
GPSMAP® 8x16 Specifications.....	221
GPSMAP® 8x17 Specifications.....	221
GPSMAP® 8x22 Specifications.....	222
GPSMAP® 8x24 Specifications.....	223
GPSMAP® 8700 Specifications.....	223
Sonar Models Specifications.....	224

Recommended Startup Image Dimensions.....	224
NMEA 2000® PGN Information.....	224
J1939 Information.....	226
NMEA® 0183 Information.....	227
Network Interfaces and Services...	228

Introduction

⚠ WARNING

See the *Important Safety and Product Information* guide in the product box for product warnings and other important information.

All route and navigation lines displayed on the chartplotter are only intended to provide general route guidance or to identify proper channels, and are not intended to be precisely followed. Always defer to the nav aids and conditions on the water when navigating to avoid groundings or hazards that could result in vessel damage, personal injury, or death.

Not all features are available on all models.

The Garmin® website at support.garmin.com presents up-to-date information about your product. The support pages will provide answers to frequently asked support questions, and you can download software and chart updates. There is also contact information to Garmin support should you have any questions.

Protective Cover

⚠ WARNING

Some protective covers may contain magnets. Under certain circumstances, magnets may cause interference with some medical devices, including pacemakers and insulin pumps. Protective covers that contain magnets should be kept away from such medical devices. Protective covers that contain magnets are flat and stick to the screen of the device, whereas covers without magnets have a lip that holds the cover to the sides of the device.

NOTICE

Some protective covers contain magnets. Under certain circumstances, magnets may cause damage to some electronic devices, including hard drives in laptop computers. Use caution when the protective cover is near electronic devices.

Before moving the vessel, remove the sun cover. Leaving the sun cover in place while the boat is moving could result in the sun cover becoming detached and possibly becoming lost or falling into the water.

The protective cover protects the screen when the device is not in use.

Device Overview



①	Touchscreen
②	Power key
③	Automatic backlight sensor





















Using the Touchscreen

- Tap the screen to select an item.
- Drag or swipe your finger across the screen to pan or scroll.
- Pinch two fingers together to zoom out.

- Spread two fingers apart to zoom in.



On-Screen Buttons

These on-screen buttons may be displayed on some screens and functions. Some buttons are accessible only in a combination page or SmartMode™ layout or when accessories, such as a radar, are connected.

Button	Function
	Clears the on-screen icons and re-centers the screen on the boat
	Opens a full-screen view of the item
	Creates a new waypoint
	Creates a route, with turns, to the destination
	Adds a turn to the route at the selected location
	Removes the last added turn from the route
	Creates a direct route, without turns, to the destination
	Creates an Auto Guidance route to the destination
	Begins navigation
	Ends navigation
	Stops and starts radar transmission
	Opens the radar gain adjustment menu
	Opens the radar sea clutter adjustment menu
	Opens the radar rain clutter adjustment menu
	Turns on and off the radar echo trails
	Acquires a radar target and begins tracking it
	Shows and sets the VRM/EBL line
	Opens the menu for the page or function
	Opens the Weather menu for the page or function
	Opens the Radar menu for the page or function
	Opens the Favorites menu for the page or function

Locking and Unlocking the Touchscreen

You can lock the touchscreen to prevent inadvertent screen touches.

- 1 Select  > **Lock Touchscreen** to lock the screen.
- 2 Select  to unlock the screen.

Connector View (8x10, 8x12, and 8x16 models)

The connectors and locations vary based upon the model. A GPSMAP® 8612xsv model is shown below.



①	2 microSD® memory card slots, 32 GB max card size.
NETWORK	Garmin® Marine Network
HDMI IN	HDMI® in
HDMI OUT	HDMI out
CVBS IN	Composite video in
AUDIO	NMEA® 0183 and audio out
POWER	Power
USB	Micro-USB to connect a compatible Garmin card reader, or to connect and control a computer using the chartplotter touchscreen
12-PIN XDCR	12-pin transducer
LVS XDCR	LiveScope™ single-array transducer
8-PIN XDCR	8-pin transducer
NMEA 2000	NMEA 2000® network
J1939	J1939 network

Connector View (8x17, 8x22, and 8x24 models)

The connectors and locations vary based upon the model. A GPSMAP® 8622 model is shown below.



POWER	Power
NETWORK	Garmin® Marine Network
HDMI IN	HDMI® in

HDMI OUT	HDMI out
CVBS IN	Composite video in
NMEA 0183	NMEA® 0183 and audio out
USB	Micro-USB to connect a compatible Garmin card reader, or to connect and control a computer using the chartplotter touchscreen
NMEA 2000	NMEA 2000® network
ENGINE/J1939	J1939 engine network

Connector View (8700 models)





POWER	Power cable connection
NETWORK	Garmin® Marine Network
HDMI IN	HDMI® in
HDMI OUT	HDMI out to connect the chartplotter to a monitor. Required for device functionality.
CVBS IN	Composite video in
①	Status LED
⏏	Power ground
⏻	Power button
NMEA 0183	NMEA® 0183 and audio out
USB HOST	Micro-USB output for connecting a touchscreen monitor
USB OTG	Micro-USB input from compatible Garmin card reader ¹ , computer, or other supported USB accessory
NMEA 2000	NMEA 2000® network
J1939	J1939 network

Tips and Shortcuts (MFD models)



- Press ⏻ to turn on the chartplotter.
- From any screen, press ⏻ repeatedly to scroll through the brightness levels, if available. This can be helpful when the brightness is so low you cannot see the screen.
- Select 🏠 from any screen to open to the home screen.
- Select **Options** to open additional settings about that screen.
- Select **Toolbars** to quickly add a toolbar overlay to the current page.
- Select ✕ to close the menu when finished.
- Press ⏻ to open additional options, such as adjusting the backlight.
- Press ⏻, and select **Power > Turn Off System**, or hold ⏻ until the **Turn Off System** bar fills to turn off the chartplotter, when available.

¹ Only compatible Garmin card readers recommended. Third-party card readers are not guaranteed to be fully compatible.

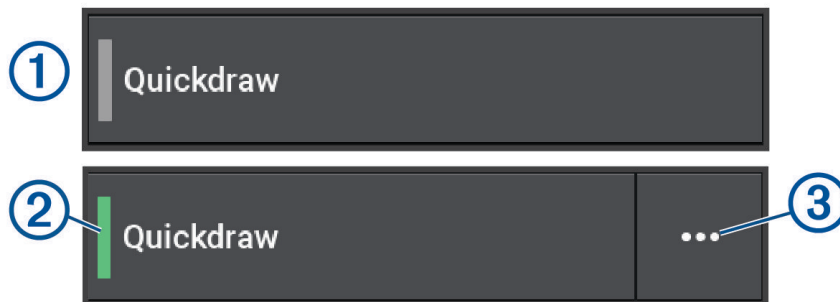





- Press , and select **Power > Sleep Station** to set the chartplotter to standby mode, when available.
To exit standby mode, select .
- Depending on the features of your chartplotter, not all feature buttons are visible are on the home screen. Swipe right or left to view the additional feature buttons.
- On some menu buttons, select the button  to enable the option.





A green light on an option indicates the option is enabled .

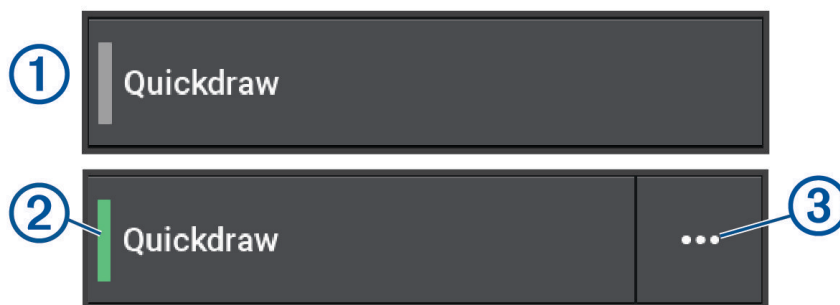

- When available, select   to open the menu.

Tips and Shortcuts (Black Box models)

- Press  to turn on the GPSMAP® 8700 device.
You can also turn on and off the device using a Garmin® chartplotter on the network or a GRID™ remote control.
You can put the device to sleep using a GRID 20 remote control, although you cannot use a GRID 20 remote control to turn it on.
- From any screen, press  repeatedly to scroll through the brightness levels when connected to a GRID remote control, or a GRID 20 remote control. This can be helpful when the brightness is so low you cannot see the screen.
- Select  from any screen to open to the home screen.
- Select **Options** to open additional settings about that screen.
- Select  to close the menu when finished.
- Press  to open additional options, depending on your installation.
- Depending on the features of your chartplotter, not all feature buttons are visible are on the home screen. Swipe right or left to view the additional feature buttons.
- On some menu buttons, select the button  to enable the option.



A green light on an option indicates the option is enabled .

- When available, select   to open the menu.

Accessing Owner's Manuals on the Chartplotter

- 1 Select  > **Owner's Manual**.
- 2 Select a manual.
- 3 Select **Open**.

Accessing the Manuals from the Web

You can get the latest owner's manual and translations of manuals from the Garmin® website. The owner's manual includes instructions for using device features and accessing regulatory information.

- 1 Go to garmin.com/manuals/GPSMAP8400-8600.
- 2 Select the *Owner's Manual*.

A web manual opens. You can download the entire manual by selecting Download PDF.

Garmin® Support Center

Go to support.garmin.com for help and information, such as product manuals, frequently asked questions, videos, software updates, and customer support.

Memory Cards

You can use optional memory cards with the chartplotter. Map cards allow you to view high-resolution satellite imagery and aerial reference photos of ports, harbors, marinas, and other points of interest. You can use blank memory cards to record Garmin Quickdraw™ Contours mapping, record sonar (with a compatible transducer), transfer data such as waypoints and routes to another compatible chartplotter or a computer, and use the ActiveCaptain® app.

The internal card readers support up to 32 GB memory cards, formatted to FAT32 with speed class 4 or higher. Use of an 8 GB or larger memory card with speed class 10 is recommended.

NOTE: When you insert a new memory card into the chartplotter, the chartplotter starts writing private information onto the newly-added card.

Model	Memory Card Location	Memory Card Type	Memory Card Size and Format
8x10	Back of the device	microSD®	Up to 32 GB, FAT32 ³
8x12	Back of the device	microSD	Up to 32 GB, FAT32 ³
8x16	Back of the device	microSD	Up to 32 GB, FAT32 ³
8x17	External card reader	SD®	Up to 1 TB, exFAT Up to 32 GB, FAT32
8x22	External card reader	SD	Up to 1 TB, exFAT Up to 32 GB, FAT32
8x24	External card reader	SD	Up to 1 TB, exFAT Up to 32 GB, FAT32
87xx	External card reader	SD	Up to 1 TB, exFAT Up to 32 GB, FAT32

Inserting Memory Cards (GPSMAP® 8x10/8x12/8x16)

The internal card readers support up to 32 GB microSD® memory cards, formatted to FAT32 with speed class 4 or higher. Use of an 8 GB or larger memory card with speed class 10 is recommended.

NOTE: When you insert a new memory card into the chartplotter, the chartplotter starts writing private information onto the newly-added card.

- 1 Open the weather cap ① on the back of the chartplotter.

As of software version 34.00, you can connect an external USB card reader and use a memory card up to 1 TB, formatted to exFAT with speed class 10 or higher.

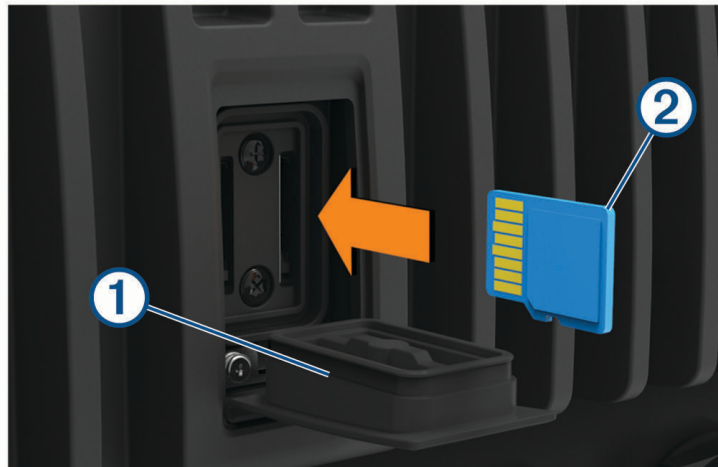

- 2 Insert the memory card ②.

There is no difference between the two card slots on the chartplotter. Any compatible card can be inserted into any open card slot, and it will be read by the chartplotter.

- 3 Press the card in until it clicks.
- 4 Clean and dry the weather cap.

NOTICE

To prevent corrosion, be sure the memory card and weather cap are thoroughly dry before closing the cap.

- 5 Press the weather cap firmly shut.

Inserting a Memory Card (GPSMAP® 8x17/8x22/8x24/87xx)

NOTE: The memory card reader is not included with the chartplotter. It is sold as a separate accessory. You can connect a USB memory card reader to the chartplotter, or you can connect the chartplotter to a Garmin BlueNet™ network or Garmin® Marine Network with another chartplotter model that has a built-in memory card slot.

As of software version 34.00, the external USB card reader supports up to a 1 TB SD® memory card, formatted to exFAT with speed class 10 or higher.

- 1 Open the door ① on the memory card reader.

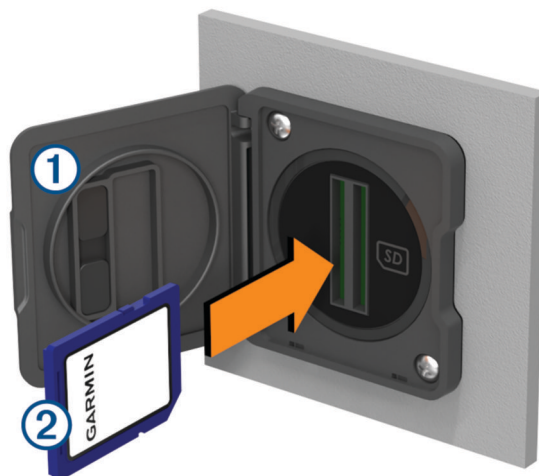

- 2 Insert the memory card ② with the label facing away from the door.
- 3 Press the card in until it clicks.
- 4 Clean and dry the gasket and door.

NOTICE

To prevent corrosion, be sure the memory card, gasket, and door are thoroughly dry before closing the door.

- 5 Close the card reader door.

Acquiring GPS Satellite Signals

The device may need a clear view of the sky to acquire satellite signals. The time and date are set automatically based on the GPS position.

- 1 Turn on the device.
- 2 Wait while the device locates satellites.
It may take 30 to 60 seconds to acquire satellite signals.

To view the GPS satellite signal strength, select  > **System** > **Satellite Positioning**.

If the device loses satellite signals, a flashing question mark appears over the boat position indicator () on the chart.

For more information about GPS, go to garmin.com/aboutGPS. For help acquiring satellite signals, see [My device will not acquire GPS signals, page 219](#).

Selecting the GPS Source

You can select your preferred source for GPS data, if you have more than one GPS source.

- 1 Select  > **System** > **Satellite Positioning** > **Source**.
- 2 Select the source for GPS data.

Customizing the Chartplotter

Home Screen

The home screen is an overlay that provides access to all of the features in the chartplotter. The features are dependent on the accessories you have connected to the chartplotter. You may not have all of the options and features discussed in this manual.

When viewing any screen, you can return to the home screen by selecting .

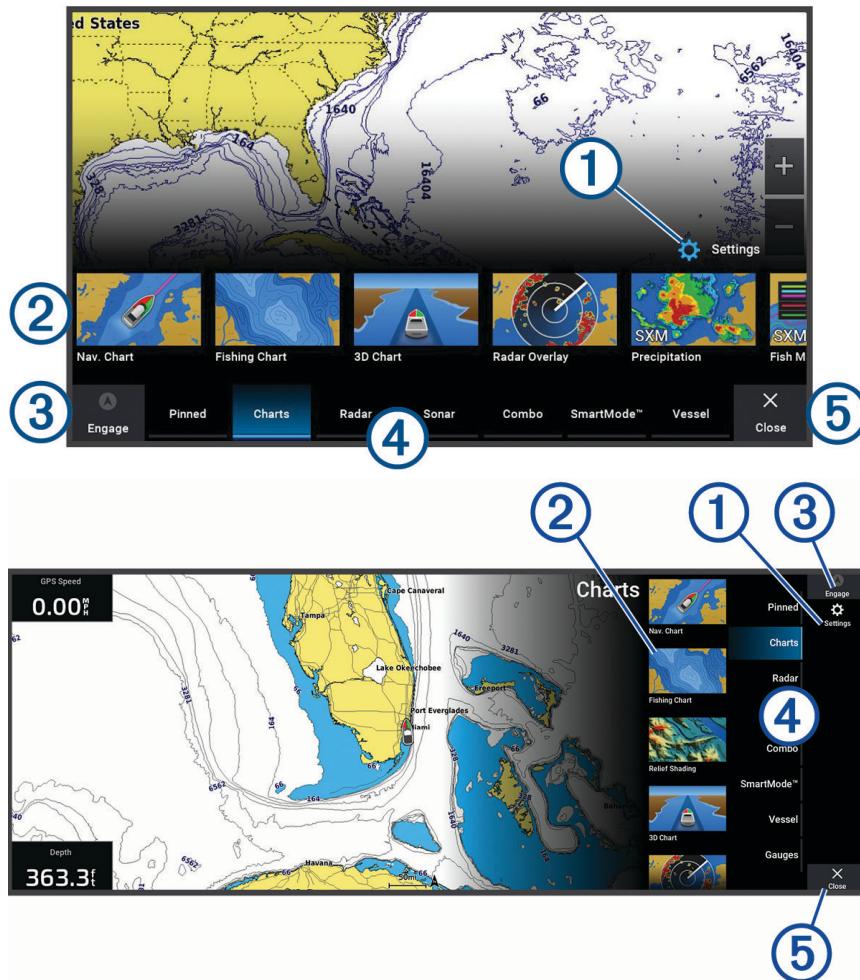

①	Settings menu button
②	Features buttons
③	Present time, present depth, or autopilot control button
④	Category tabs
⑤	Closes the home screen and returns to the previously open page

The categories tabs provide quick access to the main features of your chartplotter. For example, the Sonar tab displays the views and screens related to the sonar feature. You can save items you commonly access to the Pinned category.

TIP: To view the available categories tabs, you may need to hold and drag a tab to scroll.

The SmartMode™ items are geared toward an activity, such as cruising or docking. When a SmartMode button is selected from the home screen, each display in the station can show unique information. For example, when Cruising is selected from the home screen, one display can show the navigation chart and another display can show the radar screen.

When multiple displays are installed on the Garmin BlueNet™ network or Garmin® Marine Network, you can group them together into a station. A station enables the displays to work together, instead of as several separate

displays. You can customize the layout of the screens on each display, making each screen different on each display. When you change the layout of a screen in one display, the changes appear on only that display. When you change the name and symbol of the layout, those changes appear on all displays in the station, to maintain a consistent appearance.

Pinning a Feature Button

You can add features, such as a chart, combo screen, or gauge to the Pinned category.

NOTE: If your chartplotter has been customized by the boat manufacturer, the Pinned category contains customized items for your boat. You cannot edit the Pinned category.

- 1 Select a category, such as **Charts**.
 - 2 Hold a feature button, such as **Nav. Chart**.
 - 3 Select **Add to Pinned > OK**.
- The feature is added to the Pinned category.

To see the Pinned items, select a Pinned item, and swipe to the left or right.

To remove a feature from the Pinned category, press and hold the feature to remove, select **Remove Pin > Yes**.

Rearranging the Category Items

You can customize the screen by rearranging the items in the categories.



- 1 Select a category to customize, such as **Charts**
- 2 Hold the button you want to move, such as **Nav. Chart**, until the menu appears.
- 3 Select **Rearrange**.
Arrows appear on the feature buttons.
- 4 Reselect the button to move.
- 5 Select the new location for the button.
- 6 Repeat until you finish customizing the screen.
- 7 Select **Back** or **Close** when finished.

Menu Bar

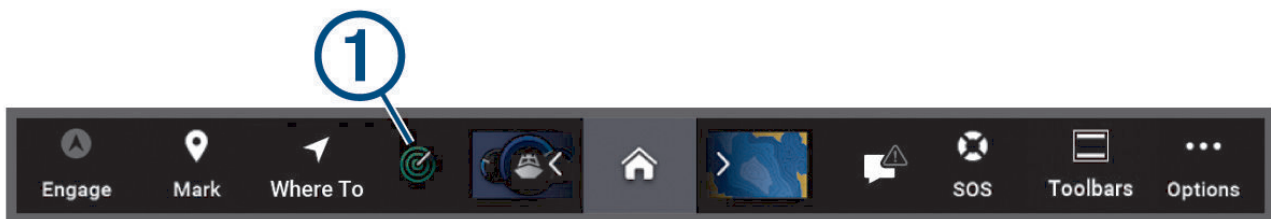
The menu bar along the bottom or the side of the screen provides access to many functions of the chartplotter, the options menu, and the home screen.



	Engages and disengages the autopilot
Engage	
	Creates a waypoint at your location
Mark	
	Opens a menu to access navigation features
Where To	
	Shows certain active function such as radar
	Opens the home screen TIP: Use the arrows to scroll through the Pinned features.
	This is shown when there are no active alerts or warnings to resolve. Opens a menu to view warnings and alerts and to access other communication such as AIS and DSC information.
	Replaces the when there is an active alert or warning to view. TIP: The icon changes color to indicate severity.

 SOS	Creates an SOS
 Toolbars	Allows you to add an overlay to the current page
	Opens the options menu

Hiding and Showing the Menu Bar

You can hide the menu bar automatically to make more screen space available.

- 1 Select  > **Preferences > Menu Bar Display > Auto.**
After a short period of time on a main page, such as a chart, the menu bar collapses down.
- 2 Swipe the screen from the bottom up to show the menu bar again.

Setting the Vessel Type

You can select the type of vessel to configure the chartplotter settings and to use features customized for your vessel.



- 1 Select  > **My Vessel > Vessel Type.**
- 2 Select an option.

Adjusting the Backlight

- 1 Select  > **System > Sounds and Display > Backlight.**
- 2 Adjust the backlight.

TIP: From any screen, press  repeatedly to scroll through the brightness levels. This can be helpful when the brightness is so low you cannot see the screen.

Adjusting the Color Mode

- 1 Select  > **System > Sounds and Display > Color Mode.**
TIP: Select  > **Color Mode** from any screen to access the color settings.
- 2 Select an option.

Adjusting the Color Theme

You can change the highlight and accent color used on most chartplotter screens.

- 1 Select  > **System > Sounds and Display > Color Theme.**
- 2 Select an option.

Enabling Screen Lock

For anti-theft protection and to prevent unauthorized use of your device, you can enable the Screen Lock feature which requires a PIN (Personal Identification Number). When enabled, you must enter the PIN to unlock the screen each time you turn on the device. You can set up recovery questions and answers as prompts in case you forget the PIN.

NOTICE

If you enable the Screen Lock feature, Garmin® Support cannot retrieve the PIN or access your device. It is your responsibility to provide the PIN to anyone authorized to use the vessel.



- 1 Select  > **System > Sounds and Display > Screen Lock > Setup.**
- 2 Enter a memorable numeric PIN of 6 digits.
- 3 Reenter the PIN to verify.
- 4 When prompted, choose and answer three PIN recovery questions.

You can Disable or Reset the PIN and recovery questions as needed.

Turning On the Chartplotter Automatically

You can set the chartplotter to turn on automatically when the power is applied. Otherwise, you must turn on the chartplotter by pressing .

Select  > **System > Auto Power Up.**

When Auto Power Up is On, and the chartplotter is turned off using , and power is removed and reapplied within less than two minutes, you may need to press  to restart the chartplotter.

Automatically Turning Off the System

You can set the chartplotter and the whole system to turn off automatically after it has been asleep for the selected length of time. Otherwise, you must press and hold  to turn off the system manually.

- 1 Select  > **System** > **Auto Power Off**.
- 2 Select an option.

Customizing Pages

Creating a New Combination Page

You can create a custom combination page to suit your needs.

- 1 Select **Combo** > **Add Combo**.
- 2 Select a window.
- 3 Select a function for the window.
- 4 Repeat these steps for each window of the page.
- 5 Hold a window to rearrange it.
- 6 Hold a data field to select new data.
- 7 Select **Layout**, and select a layout.

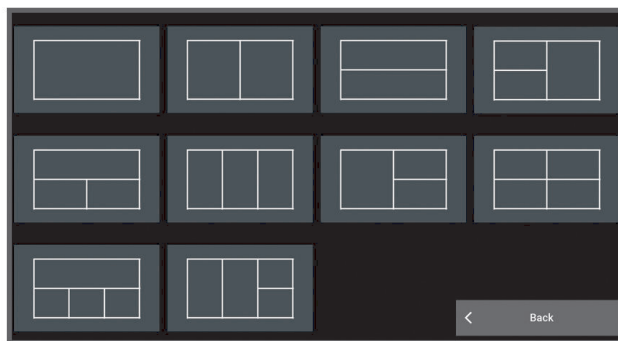

- 8 Select **Name**, enter a name for the page, and select **Done**.
- 9 Select **Overlays**, and select which data to show.
- 10 Select **Done** when you have finished customizing the page.

Adding a SmartMode™ Layout

You can add SmartMode layouts to suit your needs. Each customization made to one SmartMode layout in a station appears on all displays in the station.

- 1 Select **SmartMode™** > **Add Layout**.
- 2 Select an option:
 - To change the name, select **Name & Symbol** > **Name**, enter a new name, and select **Done**.
 - To change the SmartMode symbol, select **Name & Symbol** > **Symbol**, and select a new symbol.
 - To change the number of functions shown and the layout of the screen, select **Layout**, and select an option.
 - To change the function of a portion of the screen, select the window to change, and select a function.
 - To change how the screens are split, drag the arrows to a new location.
 - To change the data shown on the page and additional data bars, select **Overlays**, and select an option.
 - To assign a preset to a portion of the SmartMode screen, select **Favorites** > **Include**, and select a preset.

Customizing the Layout of a SmartMode™ or Combination Page

You can customize the layout and data shown in the combination pages and SmartMode layouts. When you change the layout of a page in a display you are interacting with, the change appears only on that display, except for the SmartMode name and symbol. When you change the SmartMode name or symbol for the layout, the new name or symbol appears on all displays in the station.

- 1 Open a page to customize.
- 2 Select **Options**.
- 3 Select **Edit Layout** or **Edit Combo**.
- 4 Select an option:
 - To change the name, select **Name** or **Name & Symbol > Name**, enter a new name, and select **Done**.
 - To change the SmartMode symbol, select **Name & Symbol > Symbol**, and select a new symbol.
 - To change the number of functions shown and the layout of the screen, select **Layout**, and select an option.
 - To change the function of a portion of the screen, select the window to change, and select a function from the list on the right.
 - To change how the screens are split, drag the arrows to a new location.
 - To change the data shown on the page and additional data bars, select **Overlays**, and select an option.

TIP: While viewing a screen with data overlay, hold an overlay box to quickly change the data in it.

 - To assign a preset to a portion of the SmartMode screen, select **Favorites > Include**, and select a preset from the list on the right.

Deleting a Combination Page

- 1 Select **Combo**.
- 2 Press and hold a combination page to delete.
- 3 Select **Delete Combo > Yes**.

Customizing the Data Overlays

You can customize the data in the data overlays shown on a screen.

- 1 Select an option based on the type of screen you are viewing:
 - From a full screen view, select **Options > Edit Overlays**.
 - From a combination screen, select **Options > Edit Combo > Overlays**.
 - From a SmartMode™ screen, select **Options > Edit Layout > Overlays**.

TIP: To quickly change the data shown in an overlay box, hold the overlay box.
- 2 Select an item to customize the data and data bar:
 - To show the data overlays, select **Data**, select the location, and select **Back**.
 - To change the data shown in an overlay box, select the overlay box, select the new data to show, and select **Back**.
 - To customize the information shown when navigating, select **Navigation**, and select an option.
 - To turn on other data bars, select **Top Bar**, **Bottom Bar**, **Left Bar**, or **Right Bar**, and select the necessary options.
- 3 Select **Done**.

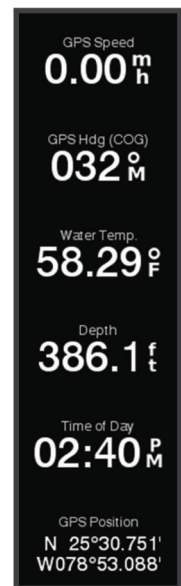

Resetting the Station Layouts

You can restore the layouts in this station to the factory default settings.

Select **⚙ > System > Station Information > Reset Layouts**.

Customizing the Startup Screen

You can personalize the image that is displayed when the chartplotter is turning on. For the best fit, the image should be 50 MB or less and conform to the recommended dimensions ([Recommended Startup Image Dimensions, page 224](#)).

- 1 Insert a memory card that contains the image you want to use.
- 2 Select **⚙ > System > Sounds and Display > Startup Image > Select Image**.
- 3 Select the memory card slot.
- 4 Select the image.
- 5 Select **Set as Startup Image**.

The new image is shown when turning on the chartplotter.

Presets

A preset is a collection of settings that optimize the screen or view. You can use particular presets to optimize groups of settings for your activity. For example, some settings might be optimal for when you are fishing, and others might be optimal for when you are cruising. Presets are available on some screens, such as charts, sonar views, and radar views.

To select a preset for a compatible screen, select **Options** > , and select the preset.

When you are using a preset and you make changes to the settings or view, you can save the changes to the preset or create a new preset based on the new customizations.

Managing Presets

You can customize the pre-loaded presets and edit presets you created.

- 1 From a compatible screen, select **Options** >  > **Manage**.
- 2 Select a preset.
- 3 Select an option:
 - To rename the preset, select **Rename**, enter a name, and select **Done**.
 - To edit the preset, select **Edit**, and update the preset.
 - To delete the preset, select **Delete**.
 - To reset all presets to factory settings, select **Reset All**.

Saving a New Preset

After you have customized the settings and view of a screen, you can save the customization as a new preset.

- 1 From a compatible screen, change the settings and view.
- 2 Select **Options** >  > **Save** > **New**.
- 3 Enter a name, and select **Done**.
- 4 Select an item, and select **Include** to include or exclude the item from the preset.

Controlling the Chartplotter

You can control the chartplotter using the touchscreen, using GRID™ remote controls, and using a Garmin® voice control device.

Voice Control

After installing the Garmin® Voice Control USB module (010-13194-00), you can use your voice to control the chartplotter using a compatible headset.

You can also use your voice to control the chartplotter using a compatible Garmin watch.

NOTE: Both headsets and Garmin watches connect to the chartplotter using Bluetooth® technology for voice control. Due to Bluetooth standards, this is not a secure, private connection.

Changing the Voice Control Language on a Garmin® Chartplotter

- 1 From the home screen, select  > **System** > **Sounds and Display** > **Voice Control**.
- 2 Select **Voice Control** > **Voice Language**.
- 3 Select the voice control language.

NOTE: The voice control language can be different than the text language.

Supported Headsets

The Garmin® chartplotter supports headsets and speakers with the following specifications:

- Bluetooth® hands-free profile version 1.6 or higher
- mSBC audio codec (16 kHz)

Headset manufacturers often list these as "HD Voice" or "Wideband Speech" headsets.

A list of supported headsets is available at support.garmin.com/marine.

Pairing a Wireless Headset with a Garmin® Chartplotter

- 1 On the chartplotter, select  > **Communications** > **Wireless Devices** > **Voice Control**.
- 2 Select **Search for Devices**.
- 3 Enable pairing mode on your headset according to the manufacturer's instructions.
The name of your headset appears on the chartplotter after it is detected.
- 4 Select the name of your headset.
- 5 Select **Connect**.

Your headset appears on the chartplotter as Paired.

Using a Wireless Headset with a Garmin® Chartplotter

Before using a wireless headset for voice control, make sure the volume on your headset is sufficient to hear voice responses.

- 1 Say **OK Garmin**.
- 2 Say a command (*Chartplotter Voice Commands, page 28*).
The chartplotter completes the action or provides a voice response.

Pairing a Garmin® Watch with a Garmin Chartplotter for Voice Control

Before you can pair a compatible Garmin watch with the chartplotter, you must enable Boat Mode on the watch.

You can pair a compatible Garmin watch to the chartplotter to send voice commands and hear replies through the watch. For more information, see the owner's manual for your compatible Garmin watch.

TIP: In addition to voice control, you can also use a compatible Garmin watch to control or view other features on the chartplotter:

- You can use the screen and buttons as a remote control to navigate the user interface (*Pairing a Garmin® Watch to Control a Garmin Chartplotter, page 38*).
- You can control a compatible connected autopilot system (*Enabling the Autopilot Controls on a Garmin® Watch, page 123*).
- You can view important data about your boat, such as depth and speed (*Viewing Boat Data on a Garmin® Watch, page 38*).

- 1 On the chartplotter, select  > **Communications** > **Wireless Devices** > **Wearables** > **Voice Control**.
- 2 Select **Search for Devices**.
- 3 Bring the Garmin watch within range (3 m) of the chartplotter.

- 4 From the watch face, hold , then select **Watch Settings > Connectivity > Chartplotter > Pair New**.
- 5 On the chartplotter, select the name of your watch.
- 6 Select **Connect**.
Your watch appears on the chartplotter as Paired.

Enabling Boat Mode on a Garmin® Watch

You must enable Boat Mode on your compatible Garmin watch before you can access some of the chartplotter-linked features, such as voice control.

- 1 On the watch, hold  to open the controls menu.
- 2 Select **Boat Mode**.

Using a Garmin® Watch with a Garmin Chartplotter for Voice Control

Before you can use Boat Command with your compatible Garmin watch, you must enable Boat Mode on the watch ([Enabling Boat Mode on a Garmin® Watch, page 28](#)).

After you pair a compatible Garmin watch with the chartplotter for voice control, you can speak a command to the watch. The chartplotter hears your voice commands, and speaks a reply through the wearable device, when applicable.

NOTE: Boat Command is available only on select quatix® models.

NOTE: If you do not hear spoken replies through your watch, make sure the volume on the watch is set high enough for the environment.

- 1 On the watch, press , and select the **Boat Command** app.

TIP: If you have not changed the default Hold START function on your watch, you can hold  to open the Boat Command app.

The app opens on the watch, and a line appears just above the menu bar on the chartplotter.

The watch beeps when it is ready for you to speak a command.

- 2 After you hear the beep from the watch, speak a voice command.

The watch beeps again to indicate it has heard the command, and the chartplotter performs the command. If it is applicable to the command, the watch speaks a reply.

Chartplotter Voice Commands

The voice command system is designed to detect natural speech. This is a list of commonly used voice commands, but the device does not require these exact phrases (other than *OK Garmin*). You can try saying variations of these commands in a way that is natural to you.

Voice Wake Word	Function
OK Garmin	Wakes up the chartplotter to listen for voice commands

Voice Help Command	Function
What can I say?	Shows a list of common voice commands

Device and Screen Functions

Voice Command	Function
Show Navigation Chart	Opens the navigation chart screen
Show Fishing Chart	Opens the fishing chart screen
Show Radar	Opens the radar screen
Show Sonar	Opens the sonar screen
Zoom In	Zooms in
Zoom Out	Zooms out
Raise Brightness	Raises the display brightness
Lower Brightness	Lowers the display brightness
Automatic Brightness	Enables automatic display brightness adjustment
Set brightness to 80	Set the brightness to a specified level. For example, you can say "Set brightness to 80," and the brightness level will adjust to 80 percent.
Sleep Display	Puts the display to sleep

Voice Command	Function
Wake Display	Wakes the display
Beeper Off	Disables the chartplotter beeper
Beeper On	Enables the chartplotter beeper
Lock Screen	Locks the chartplotter screen
Unlock Screen	Unlocks the chartplotter screen
Home Screen	Opens the home screen
Screenshot	Captures a screenshot

Vessel Functions

Voice Command	Function
What's the fuel level?	Replies with the present fuel level
What's the engine temperature?	Replies with the present engine temperature
What's the system unit voltage?	Replies with the present system unit voltage

Navigation Functions

Voice Command	Function
Mark Waypoint	Marks a waypoint at your present location
Show Waypoints	Shows a list of all waypoints saved to the device
Clear Active Track	Clears all active track information
What's the distance to the next waypoint?	Replies with the distance to next set waypoint

Media Functions

Voice Command	Function
Show Media Player	Opens the media player
Play Music	Plays the presently selected media
Pause Music	Pauses the presently selected media
Resume	Resumes playing the presently selected media
Previous Track	Returns to the previous track
Next Track	Skips to the next track
Mute	Mutes the media volume
Unmute	Unmutes the media volume
Lower Volume	Lowers the media volume
Raise Volume	Raises the media volume

Weather and Condition Functions

Voice Command	Function
What's the water temperature?	Replies with the present water temperature
What's the air temperature?	Replies with the present air temperature
What's the wind speed?	Replies with the present wind speed
What's the wind direction?	Replies with the present wind direction
When is sunrise?	Replies with the sunrise time for the present location
When is sunset?	Replies with the sunset time for the present location
Tell me the Tide Info	Replies with the present tide information
What time is it?	Replies with the present time
What's the depth?	Replies with the water depth at the present location

Radar Functions

Voice Command	Function
Start Radar Transmission	When a radar is in standby, this starts the radar transmission
Stop Radar Transmission	Stops the radar transmission and places the radar in standby
Enable Echo Trail	Enables the echo trail
Disable Echo Trail	Disables the echo trail
Clear Echo Trail	Clears the echo trail
Increase Radar Gain	Increases the radar gain
Decrease Radar Gain	Decreases the radar gain
Increase Radar Range	Increases the radar range
Decrease Radar Range	Decreases the radar range
Automatic Radar Gain High	Sets the automatic radar gain to the highest setting
Automatic Radar Gain Low	Sets the automatic radar gain to the lowest setting
Automatic Radar Gain Bird	Sets the automatic radar gain to the setting best for locating birds
Manual Radar Gain	Sets the radar gain to the last manual setting
Radar Rain Clutter On	Turns on the rain clutter filter
Radar Rain Clutter Off	Turns off the rain clutter filter
Increase Radar Rain Clutter	Increases the level of the rain clutter setting
Decrease Radar Rain Clutter	Decreases the level of the rain clutter setting
Radar Sea Clutter On	Turns on the sea clutter filter
Radar Sea Clutter Off	Turns off the sea clutter filter
Increase Radar Sea Clutter	Increases the level of the sea clutter setting
Decrease Radar Sea Clutter	Decreases the level of the sea clutter setting
Start MotionScope	Turns on the MotionScope™ feature
Stop MotionScope	Turns off the MotionScope feature

Sonar Functions

Voice Command	Function
Show Traditional Sonar	Opens the traditional sonar screen
Show Clear View	Opens the Garmin ClearVü™ sonar screen
Show Side View	Opens the Garmin SideVü™ sonar screen
Show Live Scope	Opens the LiveScope™ screen
Increase Sonar Gain	Increases the sonar gain level
Decrease Sonar Gain	Decreases the sonar gain level
Sonar Gain Automatic	Sets the sonar gain level to adjust automatically
Increase Sonar Range	Increases the sonar range
Decrease Sonar Range	Decreases the sonar range
Sonar Range Automatic	Sets the sonar range to adjust automatically
Show Front View	Opens the Garmin FrontVü™ sonar screen
Show Live Scope Down	Opens the LiveScope down sonar screen
Show Live Scope Forward	Opens the LiveScope forward sonar screen
Show Live View	Opens the LiveVü sonar screen
Show Live View Down	Opens the LiveVü down sonar screen
Show Live View Forward	Opens the LiveVü forward sonar screen
Show Real View Down	Opens the RealVü down sonar screen
Show Real View Historical	Opens the RealVü historical sonar screen

Voice Command	Function
Show Real View Forward	Opens the RealVü forward sonar screen
Increase Sonar Forward Range	Increases the sonar forward range
Decrease Sonar Forward Range	Decreases the sonar forward range
Sonar Forward Range Automatic	Sets the sonar forward range to adjust automatically
Increase Sonar Depth Range	Increases the sonar depth range
Decrease Sonar Depth Range	Decreases the sonar depth range
Sonar Depth Range Automatic	Sets the sonar depth range to adjust automatically

Garmin® Trolling Motor Functions

Voice Command	Function
Anchor Lock Enabled	Turns on and sets anchor lock
Disengage Anchor Lock	Disengages and turns off anchor lock
Cruise Control On	Turns on and engages cruise control
Disable Cruise	Disengages and turns off cruise control
Set Cruise to 3 Knots	Adjusts the cruise control speed to the spoken value
Turn to Starboard	Uses the trolling motor to turn the vessel to the starboard (right) side
Step Turn Left	Uses the trolling motor to make a small step turn to the left (port)
Set Heading Hold	Engages heading hold
Disable Heading Hold	Disengages heading hold
Jog Left	Adjusts the position of the vessel slightly left (port) when in anchor lock
Bump Port	Adjusts the position of the vessel slightly port (left) when in anchor lock
Jog Front	Adjusts the position of the vessel slightly forward when in anchor lock
Adjust Backward	Adjusts the position of the vessel slightly backward when in anchor lock
Prop On	Turns on the propeller
Motor Off	Turns off the trolling motor
Speed Up	Increases the trolling motor propeller speed one level
Speed Up by 3	Increases the trolling motor propeller speed three levels
Slow down	Decreases the trolling motor propeller speed one level
Set Speed to 10	Sets the trolling motor propeller speed to level 10
Speed to Half	Sets the trolling motor propeller to half of full speed
Speed to Full	Sets the trolling motor propeller to full speed
Turbo	Sets the trolling motor propeller speed to turbo

Before you can use voice commands to control your Garmin trolling motor, you must connect the chartplotter to the trolling motor ([Connecting to a Trolling Motor, page 128](#)).

Garmin Boat Switch™ Digital Switching Functions

Voice Command	Function
Turn on the Anchor Lights	Turns on the digital switch assigned to the anchor lights
White Light Off	Turns off the digital switch assigned to the white light, which may be referred to as the anchor light
Start Bilge 1	Turns on the digital switch assigned to the first bilge pump
Stop Bilge 1	Turns off the digital switch assigned to the first bilge pump
Run Bilge 3 Continuously	Turns on and runs the digital switch assigned to the third bilge pump in a manner where it will not turn off automatically
Set Primary Light to 80	Adjusts the brightness of the digital switch assigned to the primary light
Switch off Light 3	Turns off the digital switch assigned to the third light
Turn On Light 1	Turns on the digital switch assigned to the first light

Voice Command	Function
Raise Brightness of Light 2	Steps up the brightness for the digital switch assigned to the second light
Make Lamp 2 Not So Bright	Reduces the brightness of the digital switch assigned to the second light
Sound Horn 1	Triggers the digital switch assigned to the first horn
Stop Primary Horn	Turns off the digital switch assigned to the first horn
Sound Primary Horn for 2 Seconds	Triggers the digital switch assigned to the first horn for two seconds
Turn on Baitwell 1	Turns on the digital switch assigned to the first baitwell or live well pump
Stop Live Well 2	Turns off the digital switch assigned to the second baitwell or live well pump
Continuously Run the Sixth Bait Tank	Turns on and runs the digital switch assigned to the sixth baitwell or live well pump in a manner where it will not turn off automatically
Turn on the Navigation Lights	Turns on the digital switch assigned to the navigation lights
Switch Navigation Lights Off	Turns off the digital switch assigned to the navigation lights
Turn on Steaming Lights	Turns on the digital switch assigned to the steaming lights
Switch the Steaming Lights Off	Turns off the digital switch assigned to the steaming lights

Before you can use voice commands to control functions of your Garmin Boat Switch digital switching system, you must configure your Garmin Boat Switch device to assign identifying information to the switches you want to control using voice control ([Configuring Digital Switches for Voice Control](#), page 156).

GRID™ Remote Control

Pairing the GRID™ Device with the Chartplotter from the Chartplotter

NOTE: These steps are applicable to both the GRID device and the GRID 20 device.

Before you can pair the GRID 20 device with the chartplotter to make the data connection, you must supply power using batteries, the included power cable, or a NMEA 2000® network connection.

Before you can pair the GRID device with the chartplotter, you must connect it to the Garmin® Marine Network.

- 1 Select  > **System** > **Station Information** > **GRID™ Pairing** > **Add**.
- 2 Select an action:
 - On the GRID remote input device, press **SELECT**.
 - On the GRID 20 remote input device, press ◀ and ▶ until the remote control beeps three times.

Pairing the GRID™ Device with the Chartplotter from the GRID Device

NOTE: This is not applicable to the GRID 20 device.

- 1 On the GRID remote input device, press **+** and **HOME** at the same time.
A selection page opens on all of the chartplotters on the Garmin® Marine Network.
- 2 Rotate the wheel on the GRID remote input device to highlight **Select** on the chartplotter you want to control with the GRID remote input device.
- 3 Press **SELECT**.

Pairing the GRID™ 20 Device with the Chartplotter from the GRID 20 Device

- 1 On the GRID 20 device connected to the same NMEA 2000® network as the chartplotter, hold ◀ and ▶ until the device beeps.
A GRID™ Pairing page opens on all of the chartplotters on the network.
- 2 Press ◀ or ▶ repeatedly on the GRID20 device until **Add** is highlighted on the chartplotter you want to control with the GRID 20 device.
- 3 Press the knob to confirm.

Rotating the GRID™ Remote Input Device

For certain installation situations, you can rotate the orientation of the GRID device.

NOTE: This is not applicable to the GRID 20 device.

- 1 Select  > **Communications** > **Marine Network**.
- 2 Select the GRID device.
- 3 Select **GRID Direction** and select the installation orientation.

ActiveCaptain® App

⚠ WARNING

This feature allows users to submit information. Garmin® makes no representations about the accuracy, completeness, or timeliness of information submitted by users. Any use or reliance on the information submitted by users is at your own risk.

The ActiveCaptain app provides a connection to your GPSMAP® chartplotter, maps and charts, and the ActiveCaptain community for a connected boating experience.

On your mobile device with the ActiveCaptain app, you can download, purchase, and update maps and charts. You can use the app to easily and quickly transfer user data, such as waypoints and routes, connect to the Garmin Quickdraw™ Contours Community, update device software, and plan your trip. You can also control the GPSMAP chartplotter from the app using the Garmin Helm™ feature.

You can connect to the ActiveCaptain community for up-to-date feedback on marinas and other points of interest. The app can push smart notifications, such as calls and texts, to your chartplotter display when paired.

ActiveCaptain® and Garmin BlueNet™ Considerations

All ActiveCaptain features are compatible with Garmin BlueNet devices and legacy Garmin® Marine Network devices. When using the ActiveCaptain app with Garmin BlueNet devices, observe these considerations.

- If you have only Garmin BlueNet devices on your boat, you can insert the memory card required for the ActiveCaptain app into any chartplotter connected to the Garmin BlueNet network.
- If you connected a legacy Garmin Marine Network chartplotter to the Garmin BlueNet network using a Garmin BlueNet 30 gateway, you must insert the memory card required for the ActiveCaptain app into a Garmin BlueNet chartplotter, such as a GPSMAP® 9000 chartplotter.
 - Inserting the ActiveCaptain memory card into a legacy Garmin Marine Network chartplotter connected to a Garmin BlueNet network can result in poor system performance. For example, software updates started from the ActiveCaptain app will update only legacy Garmin Marine Network devices, and none of the Garmin BlueNet devices will be updated.
 - Inserting the ActiveCaptain memory card into a Garmin BlueNet chartplotter will result in expected performance. Software updates started from the ActiveCaptain app will update all connected devices, including all Garmin BlueNet devices and all legacy Garmin Marine Network devices.

For more information about Garmin BlueNet technology, go to garmin.com/manuals/bluenet.

ActiveCaptain® Roles

Your level of interaction with the GPSMAP® device using the ActiveCaptain app depends on your role.

Feature	Owner	Guest
Register device, built-in maps, and supplemental map cards to account	Yes	No
Update software	Yes	Yes
Automatically transfer Garmin Quickdraw™ contours you have downloaded or created	Yes	No
Push smart notifications	Yes	Yes
Automatically transfer user data, such as waypoints and routes	Yes	No
Begin navigating to a specific waypoint or navigating a specific route, and send that waypoint or route to the GPSMAP device	Yes	Yes

Getting Started with the ActiveCaptain® App

You can connect a mobile device to the GPSMAP® device using the ActiveCaptain app. The app provides a quick and easy way for you to interact with your GPSMAP device and complete such tasks as sharing data, registering, updating the device software. When configured, you can also receive mobile device notifications.

- 1 From the GPSMAP device, select **⚙ > ActiveCaptain**.
- 2 From the **ActiveCaptain** page, select **Wi-Fi Network > Wi-Fi > On**.
- 3 Enter a name and password for this network.
- 4 Insert a memory card in the GPSMAP device's card slot (*Memory Cards, page 18*).
- 5 Select **Set ActiveCaptain Card**.

NOTICE

You might be prompted to format the memory card. Formatting the card deletes all information saved on the card. This includes any saved user data, such as waypoints. Formatting the card is recommended, but not required. Before formatting the card, you should save the data from the memory card onto the device internal memory (*Copying User Data from a Memory Card, page 211*). After formatting the card for the ActiveCaptain app, you can transfer the user data back to the card (*Copying All User Data to a Memory Card, page 211*).

NOTE: Formatting the memory card in the chartplotter retains the format type and is not able to change it. If you want to change a card format from FAT32 to exFAT, for example, you must make that change using a computer or other device before using the card in the chartplotter.

Be sure the card is inserted each time you want to use the ActiveCaptain feature.

- 6 From the application store on your mobile device, install and open the ActiveCaptain app.

TIP: You can scan this QR code using your mobile device to download the app.

- 7 Bring the mobile device within 32 m (105 ft.) of the GPSMAP device.
- 8 From your mobile device settings, open the Wi-Fi® connections page, and connect to the GPSMAP device, using the name and password you entered in step 3.



Enabling Smart Notifications

⚠ WARNING

Do not read or reply to notifications while operating the vessel. Failure to pay attention to the conditions on the water can result in vessel damage, personal injury, or death.

Before your GPSMAP® device can receive notifications, you must connect it to your mobile device and to the ActiveCaptain app.

- 1 From the GPSMAP device, select **ActiveCaptain > Smart Notifications > Enable Notifications**.
- 2 Turn on Bluetooth® technology in the mobile device settings.
- 3 Bring the devices within 10 m (33 ft.) of each other.
Stay 10 m (33 ft.) away from other wireless devices while pairing.
- 4 From the ActiveCaptain app on the mobile device, select **Smart Notifications > Pair with Chartplotter**.
- 5 Follow the on-screen instructions to pair the app to the GPSMAP device.
Open Bluetooth connections are not encrypted or authenticated. For more information, see garmin.com/connectiontypes.
- 6 When prompted, enter the key on your mobile device.
- 7 If necessary, adjust which notifications you receive in your mobile device settings.

Receiving Notifications

⚠ WARNING

Do not read or reply to notifications while operating the vessel. Failure to pay attention to the conditions on the water can result in vessel damage, personal injury, or death.

Before your GPSMAP® device can receive notifications, you must connect it to your mobile device and enable the Smart Notifications feature (*Enabling Smart Notifications, page 34*).

When the Smart Notifications feature is enabled and your mobile device receives a notification, a pop-up notification appears on the GPSMAP screen briefly.

NOTE: The available actions depend on the type of notification and your phone operating system.

- To answer a phone call on your phone, select **Answer**.
TIP: Have your phone nearby. The phone call is answered on your mobile phone, not on the chartplotter.
- To not answer the phone call, select **Decline**.
- To review the full message, select **Review**.
- To dismiss the pop-up notification, select **OK** or wait for the notification to close automatically.
- To remove the notification from the chartplotter and your mobile device, select **Clear**.

Managing Notifications

WARNING

Do not read or reply to notifications while operating the vessel. Failure to pay attention to the conditions on the water can result in vessel damage, personal injury, or death.

Before you can manage the notifications, you must enable the Smart Notifications feature ([Enabling Smart Notifications, page 34](#)).

When the Smart Notifications feature is enabled and your mobile device receives a notification, a pop-up notification appears on the GPSMAP® screen briefly. You can access and manage the notifications from the ActiveCaptain screen.

1 Select **ActiveCaptain** > **Smart Notifications** > **Messages**.

TIP: You can also access these notifications from **All Communications** > **Conversations** in the messages and warnings menu ([Messages and Warnings, page 168](#)).

A list of notifications appear.

2 Select a notification.

3 Select an option:

NOTE: The available options vary based on your mobile device and the notification type.

- To dismiss and remove the notification from the chartplotter and your mobile device, select **Clear** or **Delete**.

NOTE: This does not delete the message from the mobile device. This only dismisses and removes the notification.

- To call the phone number back, select **Call Back** or **Dial**.

Making Notifications Private

You can turn off the pop-up notifications and disable the messages list on specific chartplotters for privacy. For example, the captain could disable pop-up notifications and messages on the chartplotter used for fishing, but allow notifications on the chartplotter used at the helm.

1 From the chartplotter you want notifications to be private, select **ActiveCaptain** > **Smart Notifications**.

2 Select an option:

- To turn off pop-up notifications on this chartplotter, select **Popups**.
- To turn off pop-up notifications and disable access to the messages list on this chartplotter, select **Visibility**.

Updating Software with the ActiveCaptain® App

If your device has Wi-Fi® technology, you can use the ActiveCaptain app to download and install the latest software updates for your device.

NOTICE

Software updates may require the app to download large files. Regular data limits or charges from your Internet service provider apply. Contact your Internet service provider for more information about data limits or charges.

The installation process can take several minutes.

1 Connect the mobile device to the GPSMAP® device ([Getting Started with the ActiveCaptain® App, page 33](#)).

2 When a software update is available and you have internet access on your mobile device, select **Software Updates** > **Download**.

The ActiveCaptain app downloads the update to the mobile device. When you reconnect the app to the GPSMAP device, the update is transferred to the device. After the transfer is complete, you are prompted to install the update.

3 When you are prompted by the GPSMAP device, select an option to install the update.

- To update the software immediately, select **OK**.
- To delay the update, select **Cancel**. When you are ready to install the update, select **ActiveCaptain** > **Software Updates** > **Install Now**.

For the best experience, you should keep the software on your device up to date. Software updates provide changes and improvements to privacy, security, and features.

Updating Charts with ActiveCaptain®

NOTE: Before you can update your charts, you must register them ([Getting Started with the ActiveCaptain® App, page 33](#)).

You can use the ActiveCaptain app to download and transfer the latest chart updates for your device. To shorten download time and conserve storage space, you can download only the areas of the chart you need. After you download a chart or area for the first time, updates are automatic each time you open ActiveCaptain. If you are downloading an entire chart, you can use the Garmin Express™ app to download the map onto a memory card ([Updating Your Charts Using the Garmin Express™ App, page 214](#)). The Garmin Express app downloads large charts more quickly than the ActiveCaptain app.

NOTICE

Chart updates may require the app to download large files. Regular data limits or charges from your internet service provider apply. Contact your internet service provider for more information about data limits or charges.

- 1 When you have internet access on your mobile device, select **Chart** >  > **Download Charts**.
- 2 Select the area to download.
- 3 Select **Download**.
- 4 If necessary, select the map to update.

The ActiveCaptain app downloads the update to the mobile device. When you reconnect the app to the GPSMAP® device, the update is transferred to that device. After the transfer is complete, the updated charts are available for use.

Chart Subscriptions

A chart subscription allows you to access the latest chart updates and additional content using the ActiveCaptain® mobile app. You can download updated charts and content each day.

You can purchase, activate, and renew chart subscriptions using the ActiveCaptain mobile app ([Detailed Charts, page 40](#)).

Communication with Wireless Devices

This chartplotter can host a wireless network to which you can connect wireless devices. Connecting wireless devices allows you to use Garmin® apps, such as ActiveCaptain®.

Wi-Fi® Network

Setting Up the Wi-Fi® Network

This device can host a Wi-Fi network to which you can connect wireless devices such as another chartplotter or your phone. The first time you access the wireless network settings, you are prompted to set up the network.

- 1 Select  > **Communications** > **Wi-Fi Network** > **Wi-Fi** > **On** > **OK**.
- 2 If necessary, enter a name for this wireless network.
- 3 Enter a password.

You will need this password to access the wireless network from a wireless device, such as your phone. The password is case-sensitive.

Connecting a Wireless Device to the Chartplotter

Before you can connect a wireless device to the chartplotter wireless network, you must configure the chartplotter wireless network ([Setting Up the Wi-Fi® Network, page 37](#)).

You can connect multiple wireless devices to the chartplotter to share data.

- 1 From the wireless device, turn on the Wi-Fi® technology and search for wireless networks.
- 2 Select the name of your chartplotter wireless network ([Setting Up the Wi-Fi® Network, page 37](#)).
- 3 Enter the chartplotter password.

Changing the Wireless Channel

You can change the wireless channel if you have trouble finding or connecting to a device, or if you experience interference.

- 1 Select  > **Communications** > **Wi-Fi Network** > **Advanced** > **Channel**.
- 2 Enter a new channel.

You do not need to change the wireless channel of devices connected to this network.

Changing the Wi-Fi® Host

If there are multiple chartplotters with Wi-Fi technology on the Garmin® marine network, you can change which chartplotter is the Wi-Fi host. This can be helpful if you are having trouble with Wi-Fi communications. Changing the Wi-Fi host allows you to select a chartplotter that is physically closer to your mobile device.

- 1 Select  > **Communications** > **Wi-Fi Network** > **Advanced** > **Wi-Fi Host**.
- 2 Follow the on-screen instructions.

Wireless Remote Control

These steps are not applicable to the GRID™ remote input devices [Pairing the GRID™ Device with the Chartplotter from the Chartplotter, page 32](#).

Pairing the Wireless Remote Control With the Chartplotter

Before you can use the wireless remote control with a chartplotter, you must pair the remote with the chartplotter.

You can connect a single remote to multiple plotters, and then press the pairing key to switch between the chartplotters.

- 1 Select  > **Communications** > **Wireless Devices** > **Wireless Remotes** > **GPSMAP® Remote**.
- 2 Select **New Connection**.
- 3 Follow the on-screen instructions.

Turning On and Off the Remote Backlight

Turning off the remote backlight can significantly increase the battery life.

- 1 On the chartplotter, select  > **Communications** > **Wireless Devices** > **Wireless Remotes** > **GPSMAP® Remote** > **Backlight**.
- 2 Follow the on-screen instructions.

Disconnecting the Remote Control from All Chartplotters



- 1 On the chartplotter, select  > **Communications** > **Wireless Devices** > **Wireless Remotes** > **GPSMAP® Remote** > **Disconnect All**.
- 2 Follow the on-screen instructions.

Pairing a Garmin® Watch to Control a Garmin Chartplotter

You can pair a compatible Garmin watch with your chartplotter and use the watch as a remote control to navigate the user interface. For more information, see the owner's manual for your compatible Garmin watch.

TIP: In addition to this remote-control feature, you can also use a compatible Garmin watch to control or view other features on the chartplotter:

- You can send voice commands and hear replies through the watch (*Pairing a Garmin® Watch with a Garmin Chartplotter for Voice Control, page 27*).
- You can control a compatible connected autopilot system (*Enabling the Autopilot Controls on a Garmin® Watch, page 123*).
- You can view important data about your boat, such as depth and speed (*Viewing Boat Data on a Garmin® Watch, page 38*).

- 1 On the chartplotter, select  > **Communications** > **Wireless Devices** > **Wireless Remotes** > **GPSMAP® Remote**.
- 2 Select **New Connection**.
- 3 On the compatible Garmin watch, , and select the **MFD Remote** app.
The watch should connect to the chartplotter, and the watch face shows remote control buttons that you can use to control the chartplotter.

Wireless Wind Sensor

Connecting a Wireless Sensor to the Chartplotter

You can view data from a compatible wireless sensor on the chartplotter.

- 1 Select  > **Communications** > **Wireless Devices**.
- 2 Select the wind sensor.
- 3 Select **Enable**.

The chartplotter begins searching for and connecting to the wireless sensor.

To view data from the sensor, add the data to a data field or gauge.

Adjusting the Wind Sensor Orientation

You should adjust this setting if the sensor does not face the front of the boat, exactly parallel to the center line.

The opening where the cable connects to the pole indicates the front of the sensor.



- 1 Estimate the angle, in degrees clockwise around the mast, by which the sensor points away from the center of the front of the boat:
 - If the sensor is facing starboard, the angle should be between 1 and 180 degrees.
 - If the sensor is facing port, the angle should be between -1 and -180 degrees.
- 2 Select  > **Communications** > **Wireless Devices**.
- 3 Select the wind sensor.
- 4 Select **Wind Angle Offset**.
- 5 Enter the angle observed in step 1.
- 6 Select **Done**.

Viewing Boat Data on a Garmin® Watch

You can connect a compatible Garmin watch to a compatible chartplotter to view data from the chartplotter. For more information, see the owner's manual for your compatible Garmin watch.

TIP: In addition to viewing boat data, you can also use a compatible Garmin watch to control or view other features on the chartplotter:

- You can use the screen and buttons as a remote control to navigate the user interface (*Pairing a Garmin® Watch to Control a Garmin Chartplotter, page 38*).
- You can send voice commands and hear replies through the watch (*Pairing a Garmin® Watch with a Garmin Chartplotter for Voice Control, page 27*).

- You can control a compatible connected autopilot system ([Enabling the Autopilot Controls on a Garmin® Watch, page 123](#)).
- 1 Bring the Garmin watch within range (3 m) of the chartplotter.
 - 2 From the watch face, select  > **Boat Data** > .
- NOTE:** If you have already connected to a chartplotter, and would like to connect to a different chartplotter, open the Boat Data screen, hold UP, and select Pair New.
- 3 On the chartplotter, select  > **Communications** > **Wireless Devices** > **Wearables** > **Boat Data** > **Enable Connections** > **New Connection**.
- The chartplotter begins searching for and connecting to the watch.
- After the devices are paired, they connect automatically when they are turned on and within range.

Charts and 3D Chart Views

The charts and 3D chart views that are available depend on the map data and accessories used.

NOTE: 3D chart views are available with premium charts, in some areas.

You can access the charts and 3D chart views by selecting Charts.

Nav. Chart: Shows navigation data available on your pre-loaded maps and from supplemental maps, if available. The data includes buoys, lights, cables, depth soundings, marinas, and tide stations in an overhead view.

Fishing Chart: Provides a detailed view of the bottom contours and depth soundings on the chart. This chart removes navigational data from the chart, provides detailed bathymetric data, and enhances bottom contours for depth recognition. This chart is best for offshore deep-sea fishing.

NOTE: The Fishing chart is available with premium charts, in some areas.

Perspective 3D: Provides a view from above and behind the boat (according to your course) and provides a visual navigation aid. This view is helpful when navigating tricky shoals, reefs, bridges, or channels, and is beneficial when trying to identify entry and exit routes in unfamiliar harbors or anchorages.

3D Chart: Shows a detailed, three-dimensional view from above and behind the boat (according to your course) and provides a visual navigation aid. This view is helpful when navigating tricky shoals, reefs, bridges, or channels, and when trying to identify entry and exit routes in unfamiliar harbors or anchorages.

Fish Eye 3D: Provides an underwater view that visually represents the sea floor according to the chart information. When a sonar transducer is connected, suspended targets (such as fish) are indicated by red, green, and yellow spheres. Red indicates the largest targets and green indicates the smallest.

Relief Shading: Provides high resolution elevation shading of lakes and coastal waters. This chart can be helpful for fishing and diving.

The Relief Shading chart is available with premium charts, in some areas.

Detailed Charts

This chartplotter is compatible with the latest Garmin Navionics+™ cartography and additional premium chart features. You can obtain these charts in three ways:

- You can purchase a chartplotter with preloaded detailed charts.
- You can purchase chart regions on a memory card from your Garmin® dealer or from garmin.com.
- You can purchase chart regions in the ActiveCaptain® app, and download them to your chartplotter.

NOTE: You must activate preloaded charts and charts purchased on a memory card using the ActiveCaptain app before you can access the full chart features on your chartplotter.

Activating a Marine Chart Subscription

Before you can use the full features of Garmin Navionics+™ charts that are preloaded on your device or purchased on a memory card, you must activate your subscription using the ActiveCaptain® app.

Your subscription allows you to access the latest chart updates and additional content included with your purchase.

- 1 If you purchased charts on a memory card, insert the card into a memory card slot on the chartplotter or Garmin® memory card reader.
- 2 Open the ActiveCaptain app on your mobile device, and connect it to the chartplotter (*Getting Started with the ActiveCaptain® App, page 33*).
- 3 After the ActiveCaptain app connects to the chartplotter, make sure your mobile device is connected to the internet.
- 4 In the ActiveCaptain app, select **Chart** >  > **My Charts**, and verify that an active subscription for the charts is shown in the list.
- 5 If necessary, connect the ActiveCaptain app to the chartplotter to complete the activation process. The ActiveCaptain app activates the subscription automatically after it connects to the internet and then to the chartplotter. The ActiveCaptain app shows the subscription status in the My Charts list.

NOTE: It might take a few hours to verify the new subscription.

Purchasing a Chart Subscription with ActiveCaptain®

- 1 Connect your mobile device to the internet and open the ActiveCaptain app.
- 2 Select **Chart** >  > **My Charts** > **Add a Chart Subscription**.
- 3 Select a chart.
- 4 Select **Subscribe Now**.

NOTE: It might take a few hours to display the new subscription.

Renewing Your Subscription

Your cartography subscription expires after one year. After the subscription expires, you can continue using the downloaded charts, but you are not able to download the latest chart updates or additional content.

- 1 Connect your mobile device to the internet and open the ActiveCaptain® app.
- 2 Select **Chart** >  > **My Charts**.
- 3 Select the chart to renew.
- 4 Select **Renew Now**.

NOTE: It might take a few hours to display the renewed subscription.

Navigation Chart and Fishing Chart

NOTE: The Fishing chart is available with premium charts, in some areas.



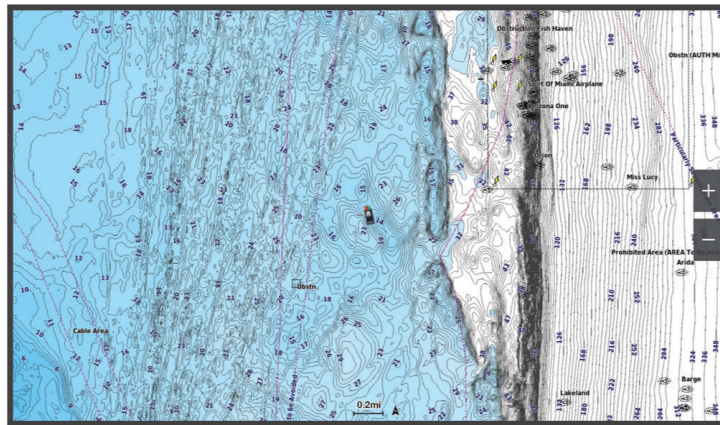



The Nav. Chart is optimized for navigation. You can plan a course, view map information, and use the chart as a navigational aid. To open the Nav. Chart, select **Charts** > **Nav. Chart**.



The Fishing Chart provides a detailed view with more bottom detail and fishing content. This chart is optimized for use when fishing. To open the Fishing Chart, select **Charts** > **Fishing Chart**.

Chart Symbols

This table contains some of the common symbols you might see on the detailed charts.

Icon	Description
	Buoy
	Information
	Marine services
	Tide station
	Current station
	Overhead photo available
	Perspective photo available

Other features common to most charts include depth contour lines, intertidal zones, spot soundings (as depicted on the original paper chart), navigational aids and symbols, obstructions, and cable areas.

Zooming In and Out Using the Touchscreen

You can quickly zoom in and out of many screens, such as the charts and sonar views.

- Pinch two fingers together to zoom out.
- Spread two fingers apart to zoom in.

Measuring a Distance on the Chart

- 1 From a chart, select a location.

2 Select **Measure**.

A push pin appears on the screen at your present location. The distance and angle from the pin is listed in the corner.

TIP: To reset the pin and measure from the current location of the cursor, select Set Reference.

Creating a Waypoint on the Chart

- 1 From a chart, select a location or object.
- 2 Select .

Viewing Location and Object Information on a Chart

You can view information, such as tide, current, celestial, chart notes, or local services, about a location or an object on the Navigation chart or the Fishing chart.

- 1 From the Navigation chart or Fishing chart, select a location or object.
A list of options appears. The options that appear vary based on the location or object you selected.
- 2 If necessary, select .
- 3 Select **Information**.

Viewing Details about Nav aids

From the Navigation chart, Fishing chart, Perspective 3D chart view, or Mariner's Eye 3D chart view, you can view details about various types of navigation aids, including beacons, lights, and obstructions.

NOTE: The Fishing chart is available with premium charts, in some areas.

NOTE: 3D chart views are available with premium charts, in some areas.

- 1 From a chart or 3D chart view, select a nav aid.
- 2 Select the name of the nav aid.

Navigating to a Point on the Chart

WARNING



All route and navigation lines displayed on the chartplotter are only intended to provide general route guidance or to identify proper channels, and are not intended to be precisely followed. Always defer to the nav aids and conditions on the water when navigating to avoid groundings or hazards that could result in vessel damage, personal injury, or death.

The Auto Guidance feature is based on electronic chart information. That data does not ensure obstacle and bottom clearance. Carefully compare the course to all visual sightings, and avoid any land, shallow water, or other obstacles that may be in your path.

When using Go To, a direct course and a corrected course may pass over land or shallow water. Use visual sightings, and steer to avoid land, shallow water, and other dangerous objects.

NOTE: The Fishing chart is available with premium charts, in some areas.

NOTE: Auto Guidance is available with premium charts, in some areas.

- 1 From the Navigation chart or Fishing chart, select a location.
- 2 If necessary, select **Navigate To**.
- 3 Select an option:
 - To navigate directly to the location, select **Go To** or .
 - To create a route to the location, including turns, select **Route To** or .
 - To use Auto Guidance, select **Auto Guidance** or .
- 4 Review the course indicated by the magenta line ([Route Color Coding, page 57](#)).
NOTE: When using Auto Guidance, a gray segment within any part of the magenta line indicates that Auto Guidance cannot calculate part of the Auto Guidance line. This is due to the settings for minimum safe water depth and minimum safe obstacle height.
- 5 Follow the magenta line, steering to avoid land, shallow water, and other obstacles.

Premium Chart Features

WARNING

All route and navigation lines displayed on the chartplotter are only intended to provide general route guidance or to identify proper channels, and are not intended to be precisely followed. Always defer to the nav aids and

conditions on the water when navigating to avoid groundings or hazards that could result in vessel damage, personal injury, or death.

The Auto Guidance feature is based on electronic chart information. That data does not ensure obstacle and bottom clearance. Carefully compare the course to all visual sightings, and avoid any land, shallow water, or other obstacles that may be in your path.

Not all models support all charts.

Optional premium charts, such as Garmin Navionics Vision+™, allow you to get the most out of your chartplotter. In addition to detailed marine charting, premium charts may contain these features, which are available in some areas.

NOTE: Not all premium chart features are available immediately after purchase. Before you can access all premium features you must activate your chart subscription and choose to download specific features using the ActiveCaptain® app ([Activating a Marine Chart Subscription, page 40](#)).

Mariner's Eye 3D: Provides a view from above and behind the boat for a three-dimensional navigation aid.

Fish Eye 3D: Provides an underwater, three-dimensional view that visually represents the sea floor according to the information on the chart.

Fishing Charts: Shows the chart with enhanced bottom contours and without navigational data. This chart works well for offshore deep-sea fishing.

High Resolution Satellite Imagery: Provides high-resolution satellite images for a realistic view of the land and water on the Navigation chart ([Showing Satellite Imagery on the Navigation Chart, page 44](#)).

Aerial Photos: Shows marinas and other navigationally significant aerial photos to help you visualize your surroundings ([Viewing Aerial Photos of Landmarks, page 44](#)).

Detailed Roads and POI data: Shows detailed road and point of interest (POI) data, which includes highly detailed coastal roads and POIs such as restaurants, lodging, and local attractions.

Auto Guidance: Uses specified information about your vessel and chart data to determine the best path to your destination.

Sonar Imagery: Shows sonar imagery to help show the density of the bottom.

Relief Shading: Shows the gradient of the bottom with shading.

Fish Eye 3D Chart View

Using the depth contour lines of the premium charts, such as Garmin Navionics Vision+™, the Fish Eye 3D chart view provides an underwater view of the sea floor or lake bottom.

Suspended targets, such as fish, are indicated by red, green, and yellow spheres. Red indicates the largest targets and green indicates the smallest.

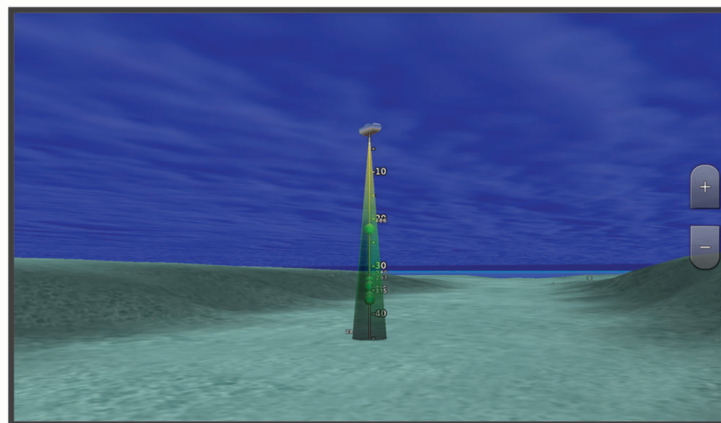

Viewing Tide Station Information

WARNING

Tide and current information is for information purposes only. It is your responsibility to heed all posted water-related guidance, to remain aware of your surroundings, and to use safe judgment in, on, and around the water at all times. Failure to heed this warning could result in property damage, serious personal injury, or death.

The  icon on the chart indicates a tide station. You can view a detailed graph for a tide station to help predict the tide level at different times or on different days.

NOTE: This feature is available with premium charts, in some areas.

1 From the Navigation chart or Fishing chart, select a tide station.

Tide direction and tide level information appear near .

2 Select the station name.

Animated Tide and Current Indicators

WARNING

Tide and current information is for information purposes only. It is your responsibility to heed all posted water-related guidance, to remain aware of your surroundings, and to use safe judgment in, on, and around the water at all times. Failure to heed this warning could result in property damage, serious personal injury, or death.

NOTE: This feature is available with premium charts, in some areas.

You can view indicators for animated tide station and current direction on the Navigation chart or the Fishing chart. You must also enable animated icons in the chart settings (*Showing Tides and Current Indicators*, page 44).

An indicator for a tide station appears on the chart as a vertical bar graph with an arrow. A red arrow pointing downward indicates a falling tide, and a blue arrow pointing upward indicates a rising tide. When you move the cursor over the tide station indicator, the height of the tide at the station appears above the station indicator.

Current direction indicators appear as arrows on the chart. The direction of each arrow indicates the direction of the current at a specific location on the chart. The color of the current arrow indicates the range of speed for the current at that location. When you move the cursor over the current direction indicator, the specific current speed at the location appears above the direction indicator.

Color	Current Speed Range
Yellow	0 to 1 knot
Orange	1 to 2 knots
Red	2 or more knots

Showing Tides and Current Indicators

NOTE: This feature is available with premium charts, in some areas.

You can show static or animated tide and current station indicators on the Navigation chart or Fishing chart.

1 From the Navigation or Fishing chart, select **Options > Layers > Chart > Tides & Currents**.

2 Select an option:

- To show animated tide station indicators and animated current direction indicators on the chart, select **Animated**.
- To enable the tides and current slider, which sets the time for which tides and currents are reported on the map, select **Slider**.

Showing Satellite Imagery on the Navigation Chart

NOTE: This feature is available with premium charts, in some areas.

You can overlay high-resolution satellite images on the land or on both land and sea portions of the Navigation chart.

NOTE: When enabled, high-resolution satellite images are present only at lower zoom levels. If you cannot see high-resolution images in your optional chart region, you can select  to zoom in. You also can set the detail level higher by changing the map zoom detail.

1 From the Navigation chart, select **Options > Layers > Chart > Satellite Photos**.

2 Select an option:

- Select **Land Only** to show standard chart information on the water, with photos overlaying the land. This setting must be enabled to view Standard Mapping® charts.
- Select **Photo Map** to show photos on both the water and the land at a specified opacity. Use the slider bar to adjust the photo opacity. The higher you set the percentage, the more the satellite photos cover both land and water.



Viewing Aerial Photos of Landmarks

Before you can view aerial photos on the Navigation chart, you must turn on the Photo Points setting in the chart setup (*Chart Layers*, page 49).

NOTE: This feature is available with premium charts, in some areas.

You can use aerial photographs of landmarks, marinas, and harbors to help orient yourself to your surroundings or to acquaint yourself with a marina or a harbor prior to arrival.

1 From the Navigation chart, select a camera icon:

- To view an overhead photo, select .
- To view a perspective photo, select . The photo was taken from the location of the camera, pointed in the direction of the cone.

2 Select **Photo**.

Automatic Identification System

WARNING

AIS and other broadcast messages are intended for situational awareness only and may not prevent collisions in all circumstances. You are responsible for the safe and prudent operation of your vessel, for remaining aware of your surroundings, and for using safe judgment on the water at all times.

The Automatic Identification System (AIS) enables you to identify and track other vessels, and alerts you to area traffic. When connected to an external AIS device, the chartplotter can show some AIS information about other vessels that are within range, that are equipped with a transponder, and that are actively transmitting AIS information.

The information reported for each vessel includes the Maritime Mobile Service Identity (MMSI), location, GPS speed, GPS heading, time that has elapsed since the last position of the vessel was reported, nearest approach, and time to the nearest approach.







Some chartplotter models also support Blue Force Tracking. Vessels being tracked with Blue Force Tracking are indicated on the chartplotter with a blue-green color.

In addition to receiving AIS information from vessels, you can also receive important broadcast messages, such as those sent for protection of marine mammals.

CAUTION

AIS broadcast messages are generated by third parties, and Garmin cannot guarantee the availability of these messages in all regions. Additionally, Garmin makes no representations about the accuracy, completeness, or timeliness of information provided by AIS broadcast messages. You must remain aware of your surroundings at all times, and any use or reliance on the information provided by AIS broadcast messages is at your own risk.

AIS Targeting Symbols

Symbol	Description
	AIS vessel. The vessel is reporting AIS information. The direction in which the triangle is pointing indicates the direction in which the AIS vessel is moving.
	Target is selected.
	Target is activated. The target appears larger on the chart. A green line attached to the target indicates the heading of the target. The MMSI, speed, and direction of the vessel appear beneath the target, if the details setting has been set to Show. If the AIS transmission from the vessel is lost, a message banner appears.
	Target is lost. A green X indicates that the AIS transmission from the vessel is lost, and the chartplotter displays a message banner asking whether the vessel should continue to be tracked. If you discontinue vessel tracking, the lost target symbol disappears from the chart or the 3D chart view.
	Dangerous target in range. The target flashes while an alarm sounds and a message banner appears. After the alarm has been acknowledged, a solid red triangle with a red line attached to it indicates the location and the heading of the target. If the safe-zone collision alarm has been set to Off, the target flashes, but the audible alarm does not sound and the alarm banner does not appear. If the AIS transmission from the vessel is lost, a message banner appears.
	Dangerous target is lost. A red X indicates that the AIS transmission from the vessel is lost, and the chartplotter displays a message banner asking whether the vessel should continue to be tracked. If you discontinue vessel tracking, the lost dangerous target symbol disappears from the chart or the 3D chart view.
	The location of this symbol indicates the closest point of approach to a dangerous target, and the numbers near the symbol indicate the time to the closest point of approach to that target.

NOTE: Vessels being tracked with the Blue Force Tracking feature are indicated with a blue-green color regardless of their status.

Heading and Projected Course of Activated AIS Targets

When heading and course over ground information are provided by an activated AIS target, the heading of the target appears on a chart as a solid line attached to the AIS target symbol. A heading line does not appear on a 3D chart view.

The projected course of an activated AIS target appears as a dashed line on a chart or a 3D chart view. The length of the projected course line is based on the value of the projected heading setting. If an activated AIS target is not transmitting speed information, or if the vessel is not moving, a projected course line does not appear. Changes in the speed, course over ground, or rate of turn information transmitted by the vessel can impact the calculation of the projected course line.

When course over ground, heading, and rate of turn information are provided by an activated AIS target, the projected course of the target is calculated based on the course over ground and the rate of turn information. The direction in which the target is turning, which is also based on the rate of turn information, is indicated by the direction of the barb at the end of the heading line. The length of the barb does not change.



When course over ground and heading information are provided by an activated AIS target, but rate of turn information is not provided, the projected course of the target is calculated based on the course over ground information.

Viewing a List of AIS Threats

- 1 From a chart or 3D chart view, select **⋮** > **Layers** > **Other Vessels** > **AIS** > **AIS List**.

TIP: You can quickly access the AIS list from the messages and warnings menu (*Messages and Warnings*, page 168).

- 2 If necessary, select **Display Options** to sort or filter the items in the list.

Activating a Target for an AIS Vessel

- 1 From a chart or 3D chart view, select **⋮** > **Layers** > **Other Vessels** > **AIS** > **AIS List**.

TIP: You can quickly access the AIS list from the messages and warnings menu (*Messages and Warnings*, page 168).

- 2 Select a vessel from the list.
- 3 Select **Review** and review the target information.
- 4 Select **Activate Target**.

Viewing Information about a Targeted AIS Vessel

You can view the AIS signal status, MMSI, GPS speed, GPS heading, and other information that is reported about a targeted AIS vessel.

- 1 From a chart or a 3D chart view, select an AIS vessel.
- 2 Select **AIS Vessel**.

Deactivating a Target for an AIS Vessel

- 1 From a chart or a 3D chart view, select an AIS vessel.
- 2 Select **AIS Vessel** > **Deactivate**.

Showing AIS Vessels on a Chart or 3D Chart View

Before you can use AIS, you must connect the chartplotter to an external AIS device and receive active transponder signals from other vessels.

You can configure how other vessels appear on a chart or on a 3D chart view. The display range configured for one chart or one 3D chart view are applied only to that chart or to that 3D chart view. The details, projected heading, and trails settings configured for one chart or one 3D chart view are applied to all charts and to all 3D chart views.

- 1 From a chart or 3D chart view, select **Options** > **Layers** > **Other Vessels** > **AIS**.
- 2 Select an option:
 - To show the tracks of AIS vessels, select **AIS Trails** and adjust the trail length if needed. .

- To indicate the distance from your location in which AIS vessels appear, select **Display Range**, and select a distance.
- To show a list of AIS-activated vessels, select **AIS List**.

Setting the Safe-Zone Collision Alarm

⚠ WARNING

The safe-zone collision alarm is a tool for situational awareness only and may not prevent collisions in all circumstances. You are responsible for the safe and prudent operation of your vessel, for remaining aware of your surroundings, and for using safe judgment on the water at all times.

⚠ CAUTION

The Beeper setting must be turned on to make alarms audible (*Sounds and Display Settings*, page 200). Failure to set audible alarms could lead to injury or property damage.

Before you can set a collision alarm, you must connect an AIS device to the same network as a compatible chartplotter.

The safe-zone collision alarm is used for AIS vessels. When a radar is connected to the same network, you can also use the safe-zone collision alarm for MARPA targets. The safe zone is used for collision avoidance and can be customized.

1 Select > **Alarms** > **Collision Alarm** > **On**.

A message banner appears and an alarm sounds when an AIS-activated vessel enters the safe-zone area around your boat. The vessel is also labeled as dangerous on the screen. When the alarm is off, the message banner and audible alarm are disabled, but the vessel is still labeled as dangerous on the screen.

2 Select **Range**, and select a distance for the safe-zone radius around your vessel.

3 Select **Time To**, and select a time at which the alarm will sound if a target is determined to intersect the safe zone.

For example, to be notified of a pending intersection 10 minutes before it will likely occur, set Time To to 10, and the alarm will sound 10 minutes before the vessel intersects the safe zone.

4 Select **MARPA Alarm**, and select an option for when the alarm sounds for MARPA-tagged objects.











A message banner appears and an alarm sounds when a MARPA-tagged object enters the safe-zone area around your boat. The object is also labeled as dangerous on the screen. When the alarm is off, the message banner and audible alarm are disabled, but the object is still labeled as dangerous on the screen.





AIS Aids to Navigation

An AIS aid to navigation (ATON) is any kind of navigational aid that is transmitted over the AIS radio. ATONs are displayed on the charts and have identifying information, such as position and type.

There are three main kinds of AIS ATONs. Real ATONs physically exist and send their identifying and location information from their actual location. Synthetic ATONs physically exist, and their identifying and location information is sent from another location. Virtual ATONs do not actually exist, and their identifying and location information is sent from another location.

You can view AIS ATONs on the chart when the chartplotter is connected to a compatible AIS radio. To show AIS ATONs, from a chart, select **Options** > **Layers** > **Chart** > **Navaid** > **ATONs**. You can view more information about an ATON if you select the ATON on the chart.

Symbol	Meaning
	Real or synthetic ATON
	Real or synthetic ATON: Topmark North
	Real or synthetic ATON: Topmark South
	Real or synthetic ATON: Topmark East
	Real or synthetic ATON: Topmark West
	Real or synthetic ATON: Topmark Special
	Real or synthetic ATON: Topmark Safe
	Real or synthetic ATON: Topmark Danger
	Virtual ATON
	Virtual ATON: Topmark North
	Virtual ATON: Topmark South

Symbol	Meaning
	Virtual ATON: Topmark East
	Virtual ATON: Topmark West
	Virtual ATON: Topmark Special
	Virtual ATON: Topmark Safe
	Virtual ATON: Topmark Danger

AIS Distress Signals





Self-contained AIS distress signal devices transmit emergency position reports when activated. The chartplotter can receive signals from Search and Rescue Transmitters (SART), Emergency Position Indicating Radio Beacons (EPIRB), and other man overboard signals. Distress signal transmissions are different than standard AIS transmissions, so they appear differently on the chartplotter. Instead of tracking a distress signal transmission for collision avoidance, you track a distress signal transmission to locate and assist a vessel or person.

Navigating to a Distress Signal Transmission

When you receive a distress signal transmission, a distress signal alarm appears.

Select **Review** > **Go To** to begin navigation to the transmission.

AIS Distress Signal Device Targeting Symbols

Symbol	Description
	AIS distress signal device transmission. Select to see more information about the transmission and begin navigation.
	Transmission lost.
	Transmission test. Appears when a vessel initiates a test of their distress signal device, and does not represent a true emergency.
	Transmission test lost.

Enabling AIS Transmission Test Alerts

To avoid a large number of test alerts and symbols in crowded areas such as marinas, you can select to receive or ignore AIS test messages. To test an AIS emergency device, you must enable the chartplotter to receive test alerts.

- 1 Select  > **Alarms** > **AIS**.
- 2 Select an option:
 - To receive or ignore Emergency Position Indicating Radio Beacon (EPRIB) test signals, select **AIS-EPIRB Test**.
 - To receive or ignore Man Overboard (MOB) test signals, select **AIS-MOB Test**.
 - To receive or ignore Search and Rescue Transponder (SART) test signals, select **AIS-SART Test**.

Turning Off AIS Reception

AIS signal reception is turned on by default.

Select  > **Other Vessels** > **AIS** > **Off**.

All AIS functionality on all charts and 3D chart views is disabled. This includes AIS vessel targeting and tracking, collision alarms that result from AIS vessel targeting and tracking, and the display of information about AIS vessels.

Turning Off AIS Broadcast Warning Messages

The reception of AIS Broadcast Warning Messages is turned on by default. This includes messages intended for the protection of marine mammals.

⚠ CAUTION

AIS broadcast messages must be turned on for you to receive them. If this feature is turned off, you will not receive these messages, including those intended for the protection of marine mammals. Failure to have these messages on could lead to injury or property damage.

Select  > **Other Vessels** > **AIS Broadcast Safety Messages**.

You will no longer receive AIS broadcast messages. You will continue to receive AIS addressed messages, because those message designations cannot be disabled.

Chart Menu

Not all settings apply to all charts. Some options require premium maps or connected accessories, such as radar.

The menus may contain some settings that are not supported by your installed charts or your present location. If you make changes to those settings, the changes will not impact the chart view.

From a chart, select **Options**.

Layers: Adjusts the appearance of the different items on the charts ([Chart Layers, page 49](#)).

Quickdraw Contours: Turns on bottom contour drawing, and allows you to create fishing map labels ([Garmin Quickdraw™ Contours Mapping, page 54](#)).

Settings: Adjusts the chart settings ([Chart Settings, page 52](#)).

Edit Overlays: Adjusts the data shown on the screen ([Customizing the Data Overlays, page 25](#)).

Chart Layers

You can turn on and off chart layers and customize features of the charts. Each setting is specific to the chart or chart view being used.

Not all settings apply to all charts and chartplotter models. Some options require premium maps or connected accessories.

The menus may contain some settings that are not supported by your installed charts or your present location. If you make changes to those settings, the changes will not impact the chart view.

From a chart, select **Options > Layers**.

Chart: Shows and hides chart-related items ([Chart Layer Settings, page 49](#)).

My Vessel: Shows and hides items relating to the boat ([My Vessel Layer Settings, page 50](#)).

Manage User Data: Shows and hides user data, such as waypoints, boundaries, and tracks, and opens user data lists ([User Data Layer Settings, page 50](#)).

Other Vessels: Adjusts how other vessels are shown ([Other Vessels Layer Settings, page 50](#)).

Water: Shows and hides depth items ([Water Layer Settings, page 51](#)).

Quickdraw Contours: Shows and hides Garmin Quickdraw™ Contours data ([Garmin Quickdraw™ Contours Settings, page 55](#)).

Weather: Shows and hides weather-related items ([Weather Layer Settings, page 51](#)).

Chart Layer Settings

From a chart, select **Options > Layers > Chart**.

Satellite Photos: Shows high-resolution satellite images on the land or on both land and sea portions of the Navigation chart, when certain premium maps are used ([Showing Satellite Imagery on the Navigation Chart, page 44](#)).

This setting must be enabled to view Standard Mapping® charts.

Tides & Currents: Shows current station indicators and tide station indicators on the chart ([Showing Tides and Current Indicators, page 44](#)) and enables the tides and current slider, which sets the time for which tides and currents are reported on the map.

Land POIs: Shows points of interest on land.

Navaid: Shows navigational aids, such as ATONs and flashing lights, on the chart. Allows you to select NOAA or IALA navaid type.

Service Points: Shows locations for marine services.

Depth: Adjusts the items on the depth layer ([Depth Layer Settings, page 49](#)).

Restricted Areas: Shows information about restricted areas on the chart.

Photo Points: Shows camera icons for aerial photos ([Viewing Aerial Photos of Landmarks, page 44](#)).

Depth Layer Settings

From a chart, select **Options > Layers > Chart > Depth**.

Depth Shading: Specifies an upper and lower depth to shade between.

Shallow Shading: Sets the shades from the shoreline to the specified depth.

Spot Depths: Turns on spot soundings and sets a dangerous depth. Spot depths that are equal to or more shallow than the dangerous depth are indicated by red text.

Fishing Contours: Sets the zoom level for a detailed view of bottom contours and depth soundings and simplifies map presentation for optimal use while fishing.

My Vessel Layer Settings

From a chart, select **Options > Layers > My Vessel**.

Heading Line: Shows and adjusts the heading line, which is a line drawn on the map from the bow of the boat in the direction of travel (*Setting the Heading Line and Angle Markers, page 76*).

Heading Line > Stern Line: Shows an extension from the stern of the boat in the opposite direction of travel.

Active Tracks: Shows the active track on the chart and opens the Active Track Options menu.

Wind Rose: Shows a visual representation of the wind angle or direction provided by the connected wind sensor and sets the wind source.

Compass Rose: Shows a compass rose around your boat, indicating compass direction oriented to the heading of the boat. Enabling this option disables the Wind Rose option.

Vessel Icon: Sets the icon that represents your present location on the chart.

Laylines Settings

To use the laylines features, you must connect a wind sensor to the chartplotter.

When in sailing mode (*Setting the Vessel Type for Sailing Features, page 68*), you can display laylines on the navigation chart. Laylines can be very helpful when racing.

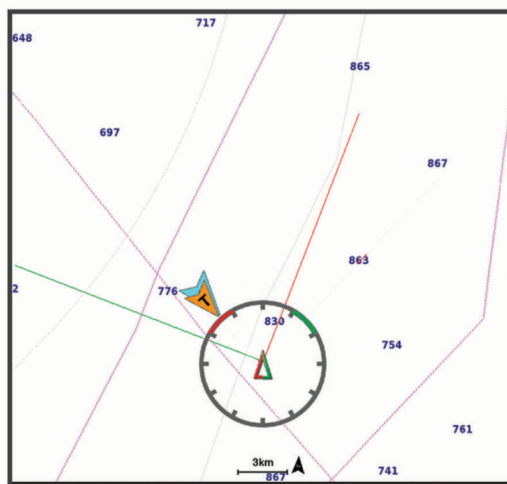

From the Navigation chart, select **Options > Layers > My Vessel > Laylines > Setup**.

Sailing Ang.: Allows you to select how the device calculates laylines. The Actual option calculates the laylines using the measured wind angle from the wind sensor. The Manual option calculates the laylines using manually entered windward and leeward angles. The Polar Table option calculates the laylines based on the imported polar table data (*Importing a Polar Table Manually, page 71*).

Windward Ang.: Allows you to set a layline based on the windward sailing angle.

Leeward Ang.: Allows you to set a layline based on the leeward sailing angle.

Layline Filter: Filters the layline data based on the time interval entered. For a smoother layline that filters out some of the changes in the boat's heading or true wind angle, enter a higher number. For laylines that display a higher sensitivity to changes in the boat's heading or true wind angle, enter a lower number.

User Data Layer Settings

You can show user data, such as waypoints, boundaries, and tracks, on the charts.

From a chart, select **Options > Layers > Manage User Data**.

Waypoints: Shows waypoints on the chart and opens the list of waypoints.

Boundaries: Shows boundaries on the chart and opens the list of boundaries.

Tracks: Shows tracks on the chart.

Other Vessels Layer Settings

These options require connected accessories, such as an AIS receiver or VHF radio.

From a chart, select **Options > Layers > Other Vessels**.

DSC: Sets how DSC vessels and trails appear on the chart, and shows the DSC list.

AIS: Sets how AIS vessels and trails appear on the chart, and shows the AIS list.

MARPA: Sets how MARPA vessels and trails appear on the chart, and shows the MARPA list.

Details: Shows other vessel details on the chart.

Proj. Heading: Sets the projected heading time for AIS-activated vessels. This also sets the projected heading time for MARPA-tagged vessels.

Collision Alarm: Sets the safe-zone collision alarm ([Setting the Safe-Zone Collision Alarm, page 47](#)).

Water Layer Settings

From a chart, select **Options > Layers > Water**.

The menu may contain some settings that are not supported by your installed charts or your present location. If you make changes to those settings, the changes will not impact the chart view.

NOTE: Not all settings apply to all charts, views, and chartplotter models. Some options require premium maps or connected accessories.

Depth Shading: Specifies an upper and lower depth to shade between ([Depth Range Shading, page 51](#)).

Shallow Shading: Sets the shades from the shoreline to the specified depth.

Spot Depths: Turns on spot soundings and sets a dangerous depth. Spot depths that are equal to or more shallow than the dangerous depth are indicated by red text.

Fishing Contours: Sets the zoom level for a detailed view of bottom contours and depth soundings and simplifies map presentation for optimal use while fishing.

Relief Shading: Shows the gradient of the bottom with shading. This feature is available only with some premium maps.

Sonar Imagery: Shows sonar imagery to help show the density of the bottom. This feature is available only with some premium maps.

Lake Level: Sets the present water level of the lake. This feature is available only with some premium maps.

Depth Range Shading

You can set color ranges on your map to show the water depths where your target fish are currently biting. You can set deeper ranges to monitor how quickly the bottom depth changes within a specific depth range. You can create up to ten depth ranges. For inland fishing, a maximum of five depth ranges can help reduce map clutter. The depth ranges apply to all charts and all bodies of water.

Some Garmin LakeVü™ and premium supplemental charts have multiple depth range shading by default.

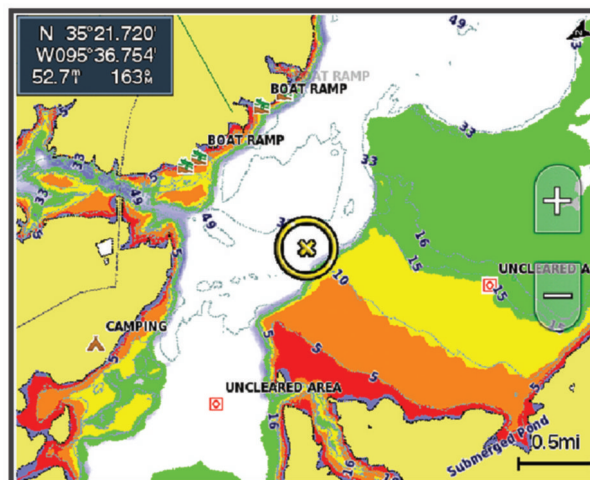

Red	From 0 to 1.5 m (from 0 to 5 ft.)
Orange	From 1.5 to 3 m (from 5 to 10 ft.)
Yellow	From 3 to 4.5 m (from 10 to 15 ft.)
Green	From 4.5 to 6.1 m (from 15 to 20 ft.)

To turn on and adjust, from a chart, select **Options > Layers > Water > Depth Shading**.

Weather Layer Settings

From the Navigation or Fishing chart, select **Options > Layers > Chart > Weather > ☁**.

From a weather chart, select **Options > Layers > Chart > Weather**.

Observed Layers: Sets which observed weather items are shown. Observed weather is the present weather condition that are visible now.

Forecast Layers: Sets which forecasted weather items are shown.

Layer Mode: Shows forecasted or observed weather information.

Loop: Shows a loop of forecasted or observed weather information.

Legend: Shows the weather legend, with the severity of the conditions increasing from left to right.

Weather Subscription: Shows weather subscription information.

Restore Defaults: Resets the weather settings to factory default values.

Edit Overlays: Adjusts the data shown on the screen (*Customizing the Data Overlays*, page 25).

Radar Overlay Settings

From the Navigation or Fishing chart, select **Options > Layers > Radar > **.

From a radar screen, select **Options**.

Radar To Standby: Stops radar transmission.

Gain: Adjusts the gain (*Adjusting Gain on the Radar Screen Automatically*, page 114).

Sea Clutter: Adjusts the sea clutter (*Adjusting Gain on the Radar Screen Automatically*, page 114).

Radar Options: Opens the radar options menu (*Radar Options Menu*, page 116).

Other Vessels: Sets how other vessels are displayed on the radar view (*Other Vessels Layer Settings*, page 50).

Radar Setup: Opens the radar display settings (*Radar Setup Menu*, page 116).

Edit Overlays: Adjusts the data shown on the screen (*Customizing the Data Overlays*, page 25).

Chart Settings

Not all settings apply to all charts and 3D chart views. Some settings require external accessories or applicable premium charts.

From a chart, select **Options > Chart Settings**.

Map Orientation: Sets the perspective of the map.

Look Ahead: Shifts your present location toward the bottom of the screen automatically as your speed increases. Enter your top speed for the best results.

Vessel Orientation: Sets the alignment of the vessel icon on the map. The Auto option aligns the vessel icon using GPS COG at high speeds and the magnetic heading at low speeds to better align the vessel icon with the active track line. The Heading option aligns the vessel icon with the magnetic heading. The GPS Heading (COG) option aligns the vessel icon using GPS COG. If the selected data source is not available, the available data source is used instead.

WARNING

The vessel orientation setting is for informational purposes and is not intended to be precisely followed. Always defer to the nav aids and conditions on the water to avoid groundings or hazards that could result in vessel damage, personal injury, or death.

You can set the Map Orientation and Vessel Orientation settings separately for two navigation charts used in a combination page.

Detail: Adjusts the amount of detail shown on the map, at different zoom levels.

Chart Size: Sets the visible size of the chart.

World Map: Uses either a basic world map or a shaded relief map on the chart. These differences are visible only when zoomed out too far to see the detailed charts.

Start Line: Sets the starting line for the sailing race (*Setting the Starting Line*, page 69).

Inset Map: Shows a small map centered on your present location.

Fish Eye 3D Settings

NOTE: This feature is available with premium charts, in some areas.

From the Fish Eye 3D chart view, select **Options**.

View: Sets the perspective of the 3D chart view.

Tracks: Shows tracks.

Sonar Cone: Shows a cone that indicates the area covered by the transducer.

Fish Symbols: Shows suspended targets.

Supported Maps

To help you have a safe and enjoyable time on the water, Garmin® devices only support official maps produced by Garmin or an approved third party producer.

You can purchase maps from Garmin. If you purchase maps from a seller other than Garmin, investigate the seller before purchasing. Be extra cautious with online sellers. If you have purchased an unsupported map, return it to the seller.

Garmin Quickdraw™ Contours Mapping

⚠ WARNING

The Garmin Quickdraw Contours mapping feature allows users to generate maps. Garmin® makes no representations about the accuracy, reliability, completeness or timeliness of the maps generated by third parties. Any use or reliance on the maps generated by third parties is at your own risk.

The Garmin Quickdraw Contours mapping feature allows you to instantly create maps with contours and depth labels for any body of water.

When Garmin Quickdraw Contours records data, a colored circle surrounds the vessel icon. This circle represents the approximate area of the map that is scanned by each pass.

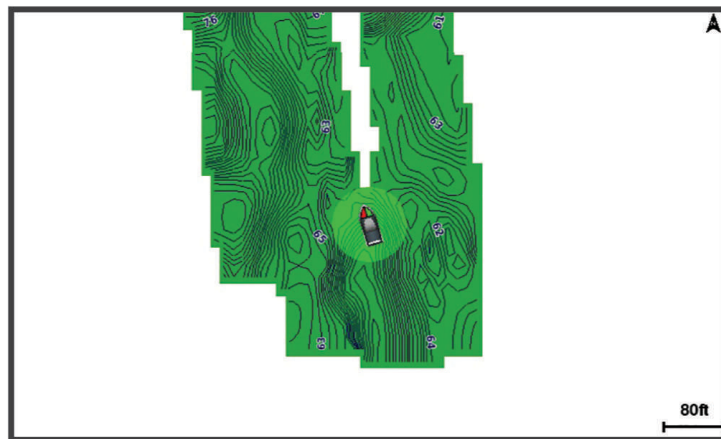

A green circle indicates good depth and GPS position, and a speed under 16 km/h (10 mph). A yellow circle indicates good depth and GPS position, and a speed between 16 and 32 km/h (10 and 20 mph). A red circle indicates poor depth or GPS position, and a speed above 32 km/h (20 mph).

You can view Garmin Quickdraw Contours in a combination screen or as a single view on the map.

The amount of saved data depends on the size of your memory card, your sonar source, and the speed of your boat as you record data. You can record longer when you use a single-beam sonar. It is estimated that you might be able to record about 1,500 hours of data onto a 2 GB memory card.

When you record data on a memory card in your chartplotter, the new data is added to your existing Garmin Quickdraw Contours map, and is saved on the memory card. When you insert a new memory card, the existing data does not transfer onto the new card.

Mapping a Body of Water Using the Garmin Quickdraw™ Contours Feature

Before you can use the Garmin Quickdraw Contours feature, you must have sonar depth, your GPS position, and a memory card with free space.

- 1 From a chart view, select **Options > Quickdraw Contours > Start Recording**.
- 2 When recording is complete, select **Options > Quickdraw Contours > Stop Recording**.
- 3 Select **Manage > Name**, and enter a name for the map.

Adding a Label to a Garmin Quickdraw™ Contours Map

You can add labels to a Garmin Quickdraw Contours map to mark hazards or points of interest.

- 1 From the Navigation chart, select a location.
- 2 Select **Quickdraw Lbl.**
- 3 Enter text for the label, and select **Done**.

Garmin Quickdraw™ Community

The Garmin Quickdraw Community is a free, public, online community that enables you to download maps other users have created. You can share your Garmin Quickdraw Contours maps with others. You must use the ActiveCaptain® app to access the Garmin Quickdraw Community ([Connecting to the Garmin Quickdraw™ Community with ActiveCaptain®, page 55](#)).

NOTE: The Garmin® device must have a memory card slot and Wi-Fi® technology to participate in the Garmin Quickdraw Community.

Connecting to the Garmin Quickdraw™ Community with ActiveCaptain®

- 1 From your mobile device, open the ActiveCaptain app and connect to the GPSMAP® device (*Getting Started with the ActiveCaptain® App*, page 33).
- 2 From the app, select **Quickdraw Community**.

You can download contours from others in the community (*Downloading Garmin Quickdraw™ Community Maps Using ActiveCaptain®*, page 55) and share the contours you have created (*Sharing Your Garmin Quickdraw™ Contours Maps with the Garmin Quickdraw Community Using ActiveCaptain®*, page 55).

Downloading Garmin Quickdraw™ Community Maps Using ActiveCaptain®

You can download Garmin Quickdraw Contours maps that other users have created and shared with the Garmin Quickdraw Community.

- 1 From the ActiveCaptain app on your mobile device, select **Quickdraw Community > Search for Contours**.
- 2 Use the map and search features to locate an area to download.
The red dots represent Garmin Quickdraw Contours maps that have been shared for that area.
- 3 Select **Select Download Region**.
- 4 Drag the box to select the area to download.
- 5 Drag the corners to change the download area.
- 6 Select **Download Area**.

The next time you connect the ActiveCaptain app to the GPSMAP® device, the downloaded contours are transferred to the device automatically.

Sharing Your Garmin Quickdraw™ Contours Maps with the Garmin Quickdraw Community Using ActiveCaptain®

You can share Garmin Quickdraw Contours maps that you have created with others in the Garmin Quickdraw Community.

When you share a contour map, only the contour map is shared. Your waypoints are not shared.

When you set up your ActiveCaptain app, you may have selected to share your contours with the community automatically. If not, follow these steps to enable sharing.

From the ActiveCaptain app on your mobile device, select **Sync with Plotter > Contribute to Community**.

The next time you connect the ActiveCaptain app to the GPSMAP® device, your contour maps are transferred to the community automatically.

Garmin Quickdraw™ Contours Settings

From a chart, select **Options > Quickdraw Contours > Settings**.

Recording Offset: Sets the distance between the sonar depth and the contour recording depth. If the water level has changed since your last recording, adjust this setting so the recording depth is the same for both recordings.

For example, if the last time you recorded had a sonar depth of 3.1 m (10.5 ft.), and today's sonar depth is 3.6 m (12 ft.), enter -0.5 m (-1.5 ft.) for the a Recording Offset value.

User Display Offset: Sets differences in contour depths and depth labels on your own contours maps to compensate for changes in the water level of a body of water, or for depth errors in recorded maps.

Comm. Display Offset: Sets differences in contour depths and depth labels on the community contours maps to compensate for changes in the water level of a body of water, or for depth errors in recorded maps.

Survey Coloring: Sets the color of the Garmin Quickdraw Contours display. When this setting is turned on, the colors indicate the quality of the recording. When this setting is turned off, the contour areas use standard map colors.

Green indicates good depth and GPS position, and a speed under 16 km/h (10 mph). Yellow indicates good depth and GPS position, and a speed between 16 and 32 km/h (10 and 20 mph). Red indicates poor depth or GPS position, and a speed above 32 km/h (20 mph).

Depth Shading: Specifies the minimum and maximum depths of a depth range and a color for that depth range.

Navigation with a Chartplotter

⚠ WARNING

All route and navigation lines displayed on the chartplotter are only intended to provide general route guidance or to identify proper channels, and are not intended to be precisely followed. Always defer to the nav aids and conditions on the water when navigating to avoid groundings or hazards that could result in vessel damage, personal injury, or death.

The Auto Guidance feature is based on electronic chart information. That data does not ensure obstacle and bottom clearance. Carefully compare the course to all visual sightings, and avoid any land, shallow water, or other obstacles that may be in your path.

When using Go To, a direct course and a corrected course may pass over land or shallow water. Use visual sightings, and steer to avoid land, shallow water, and other dangerous objects.

⚠ CAUTION

If your vessel has an autopilot system, a dedicated autopilot control display must be installed at each steering helm in order to disable the autopilot system.

Some chart views are available with premium charts, in some areas.

To navigate, you must choose a destination, set a course or create a route, and follow the course or route. You can follow the course or the route on the Navigation chart, Fishing chart, Perspective 3D chart view, or Mariner's Eye 3D chart view.

You can set and follow a course to a destination using one of three methods: Go To, Route To, or Auto Guidance.

Go To: Takes you directly to the destination. This is the standard option for navigating to a destination. The chartplotter creates a straight-line course or navigation line to the destination. The path may run over land and other obstacles.

Route To: Creates a route from your location to a destination, allowing you to add turns along the way. This option provides a straight-line course to the destination, but allows you to add turns into the route to avoid land and other obstacles.

Auto Guidance: Uses the specified information about your vessel and chart data to determine the best path to your destination. This option is available only when using a compatible premium chart in a compatible chartplotter. It provides a turn-by-turn navigation path to the destination, avoiding land and other obstacles ([Auto Guidance, page 62](#)).

When you are using a compatible autopilot connected to the chartplotter using NMEA 2000®, the autopilot follows the Auto Guidance route.

NOTE: Auto Guidance is available with premium charts, in some areas.

The color of the route line changes depending upon several factors ([Route Color Coding, page 57](#)).

Basic Navigation Questions

Question	Answer
How do I make the chartplotter point me in the direction in which I want to go (bearing)?	Navigate using Go To (Setting and Following a Direct Course Using Go To, page 57).
How do I make the device guide me along a straight line (minimizing cross track) to a location using the shortest distance from the present location?	Build a single-leg route and navigate it using Route To (Creating and Navigating a Route From Your Present Location, page 60).
How do I make the device guide me to a location while avoiding charted obstacles?	Build a multi-leg route and navigate it using Route To (Creating and Navigating a Route From Your Present Location, page 60).
How do I make the device steer my automatic pilot?	Navigate using Route To (Creating and Navigating a Route From Your Present Location, page 60).
Can the device create a path for me?	If you have premium maps that support Auto Guidance and are in an area covered by Auto Guidance, navigate using Auto Guidance (Setting and Following an Auto Guidance Path, page 62).
How do I change the Auto Guidance settings for my boat?	See Auto Guidance Path Configurations, page 63 .

Route Color Coding

WARNING

All route and navigation lines displayed on the chartplotter are only intended to provide general route guidance or to identify proper channels, and are not intended to be precisely followed. Always defer to the nav aids and conditions on the water when navigating to avoid groundings or hazards that could result in vessel damage, personal injury, or death.

The Auto Guidance feature is based on electronic chart information. That data does not ensure obstacle and bottom clearance. Carefully compare the course to all visual sightings, and avoid any land, shallow water, or other obstacles that may be in your path.

When using Go To, a direct course and a corrected course may pass over land or shallow water. Use visual sightings, and steer to avoid land, shallow water, and other dangerous objects.

As you navigate, the color of the route might change to indicate when you should take caution.

Magenta: Default route/course line.

Thin purple: Dynamically corrected course, indicating you are off course.

Orange: Caution! This segment of the route may be near the thresholds of the Auto Guidance depth and height settings. For example, the route segment is orange when the route crosses under a bridge or is in potentially shallow waters. Garmin Navionics+™ and Garmin Navionics Vision+™ charts only.

Red striped: Warning! This segment of the route might be unsafe, based on the Auto Guidance depth and height settings. For example, the route segment is red striped when the route crosses under a very low bridge or is in shallow waters. This line is red striped in Garmin Navionics+ and Garmin Navionics Vision+ charts only; it is magenta and gray striped in previous versions of the charts.

Gray: Cannot calculate this segment of the route due to land or other obstacles, or there is no chart coverage area in that location.

Destinations

You can select destinations using various charts and 3D chart views or using the lists.

Searching for a Destination by Name

You can search for saved waypoints, saved routes, saved tracks, and marine services destinations by name.

- 1 Select **Where To > Services > Search by Name**.
- 2 Enter at least a portion of the name of your destination.
- 3 If necessary, select **Done**.
The 50 nearest destinations that contain your search criteria appear.
- 4 Select the destination.

Selecting a Destination Using the Navigation Chart

From the Navigation chart, select a destination.

Searching for a Marine Services Destination

NOTE: This feature is available with premium charts, in some areas.

The chartplotter contains information for thousands of destinations offering marine services.

- 1 Select **Where To > Services**.
- 2 Select **Offshore Services** or **Inland Services**.
- 3 If necessary, select the marine service category.
The chartplotter shows a list of the nearest locations and the distance and bearing to each.
- 4 Select a destination to view more information about the destination, if available.
You can touch and drag up and down to scroll through the list of nearest destinations.

Setting and Following a Direct Course Using Go To

WARNING

When using Go To, a direct course and a corrected course may pass over land or shallow water. Use visual sightings, and steer to avoid land, shallow water, and other dangerous objects.

You can set and follow a direct course from your current location to a selected destination.

- 1 Select a destination ([Destinations, page 57](#)).

2 Select **Navigate To > Go To**.

A magenta line appears. In the center of the magenta line is a thinner purple line that represents the corrected course from your current location to the destination. The corrected course is dynamic, and it moves with your boat when you are off course.

3 Follow the magenta line, steering to avoid land, shallow water, and other obstacles.

4 If you are off course, follow the purple line (corrected course) to go to your destination, or steer back to the magenta line (direct course).

You can also use the orange course-to-steer arrow, which shows a proposed turning radius to return your boat to the course.

WARNING

Review the path for obstacles before negotiating the turn. If the path is unsafe, reduce your boat speed and determine a safe path back to the course.

Stopping Navigation

While navigating, from an applicable chart, select an option:

- Select **Options > Stop Navigation**.
- When navigating with Auto Guidance, select **Options > Navigation Options > Stop Navigation**.
- Select .

Waypoints

Waypoints are locations you record and store in the device. Waypoints can mark where you are, where you are going, or where you have been. You can add details about the location, such as name, elevation, and depth.

Marking Your Present Location as a Waypoint

From any screen, select **Mark**.

Creating a Waypoint at a Different Location

1 From a chart, select **Where To > Waypoints > New Waypoint**.

2 Select an option:

- To create the waypoint by entering position coordinates, select **Enter Coordinates**, and enter the coordinates.
- To create the waypoint using a chart, select **Use Chart**, select the location, and select **Create Waypoint**.
- To create the waypoint using a range (distance) and bearing, select **Enter Range/Bearing**, and enter the information.

Marking a Man Overboard or Other SOS Location

You must connect a VHF radio to the chartplotter before you can use the chartplotter to initiate SOS calls.

You can use the chartplotter to mark a man overboard or SOS location and immediately begin navigating to the marked location. If you have a VHF radio connected to the chartplotter, you can also broadcast the SOS information.

If you have a compatible inReach® device connected to the chartplotter, you can initiate an inReach SOS and communicate with the Garmin ResponseSM team while you wait for help to arrive ([Sending an inReach® SOS Call](#), page 154).

1 Select **SOS**.

2 Select **Man Overboard** or the SOS type.

3 If necessary, select **Yes** to navigate to the SOS location.

If you selected Yes, the chartplotter sets a direct course back to the location.

The call details are sent to the VHF radio. You must send the call using the radio.

Projecting a Waypoint

You can create a new waypoint by projecting the distance and bearing from a different location. This can be helpful when creating sail racing start and finish lines.

1 Select **Where To > Waypoints > New Waypoint > Enter Range/Bearing**.

2 If necessary, select a reference point on the chart.

3 Select **Enter Range/Bearing**.

4 Enter the distance, and select **Done**.

- 5 Enter the bearing, and select **Done**.
- 6 Select **Create Waypoint**.

Viewing a List of all Waypoints

Select an option:

- Select **Where To > Waypoints**.
- From a chart or 3D chart view, select **Options > Waypoints**.

Editing a Saved Waypoint

- 1 Select **Where To > Waypoints**.
- 2 Select a waypoint.
- 3 Select **Review > Edit**.
- 4 Select an option:
 - To add a name, select **Name**, and enter a name.
 - To change the symbol, select **Symbol**.
 - To move the position of the waypoint, select **Position**.
 - To change the depth, select **Depth**.
 - To change the water temperature, select **Water Temp..**
 - To change the comment, select **Comment**.

Moving a Saved Waypoint

- 1 Select **Where To > Waypoints**.
- 2 Select a waypoint.
- 3 Select **Review > Edit > Position**.
- 4 Indicate a new location for the waypoint:
 - To move the waypoint using coordinates, select **Enter Coordinates**, enter the new coordinates, and select **Done** or **Cancel**.
 - To move the waypoint while using the chart, select **Use Chart**, select a new location on the chart, and select **Move Waypoint**.
 - To move the waypoint using the vessel's current position, select **Use Current Position**.
 - To move the waypoint using a range (distance) and bearing, select **Enter Range/Bearing**, enter the information, and select **Done**.

Browsing for and Navigating to a Saved Waypoint

WARNING

All route and navigation lines displayed on the chartplotter are only intended to provide general route guidance or to identify proper channels, and are not intended to be precisely followed. Always defer to the nav aids and conditions on the water when navigating to avoid groundings or hazards that could result in vessel damage, personal injury, or death.

The Auto Guidance feature is based on electronic chart information. That data does not ensure obstacle and bottom clearance. Carefully compare the course to all visual sightings, and avoid any land, shallow water, or other obstacles that may be in your path.

When using Go To, a direct course and a corrected course may pass over land or shallow water. Use visual sightings, and steer to avoid land, shallow water, and other dangerous objects.

NOTE: Auto Guidance is available with premium charts, in some areas.

Before you can navigate to a waypoint, you must create a waypoint.

- 1 Select **Where To > Waypoints**.
- 2 Select a waypoint.
- 3 Select **Navigate To**.
- 4 Select an option:
 - To navigate directly to the location, select **Go To**.
 - To create a route to the location, including turns, select **Route To**.
 - To use Auto Guidance, select **Auto Guidance**.
- 5 Review the course indicated by the magenta line.

NOTE: When using Auto Guidance, a gray segment within any part of the magenta line indicates that Auto Guidance cannot calculate part of the Auto Guidance line. This is due to the settings for minimum safe water depth and minimum safe obstacle height.

- 6 Follow the magenta line, steering to avoid land, shallow water, and other obstacles.

NOTE: In the center of the magenta line is a thinner purple line that represents the direct course from your current location to your destination. The direct course is dynamic, and it moves with your boat when you are off course.

Deleting a Waypoint or an MOB

- 1 Select **Where To > Waypoints**.
- 2 Select a waypoint or an MOB.
- 3 Select **Review > Delete**.

Deleting All Waypoints

Select **Where To > Manage User Data > Delete User Data > Waypoints > All**.

Routes

A route is a path from one location to one or more destinations.

Creating and Navigating a Route From Your Present Location

You can create and immediately navigate a route on the Navigation chart or the Fishing chart. This method does not save the route.

- 1 From the Navigation chart or Fishing chart, select a destination.
- 2 Select **Route To**.
- 3 Select the location of the last turn before the destination.
- 4 Select **Add Turn**.
- 5 If necessary, repeat to add turns, working backward from the destination to the present location of your vessel.

The last turn you add should be the first turn you make, starting from your present location. It should be the turn closest to your vessel.

- 6 Select **Done**.
- 7 Review the course indicated by the magenta line.
- 8 Follow the magenta line, steering to avoid land, shallow water, and other obstacles.

NOTE: In the center of the magenta line is a thinner purple line that represents the direct course from your current location to the next route turn. The direct course is dynamic, and it moves with your boat when you are off course.

Creating and Saving a Route

You can add up to 250 turns to one route.

- 1 Select **Where To > Routes > New > Route Using Chart**.
- 2 Select the starting location of the route.
The starting point can be your present location or another location.
- 3 Select **Add Turn**.
- 4 Select the location of the next turn on the chart.
- 5 Select **Add Turn**.
- 6 If necessary, repeat steps 4 and 5 to add more turns.
- 7 Select **Done**.

Viewing a List of Routes and Auto Guidance Paths

- 1 Select **Where To > Routes**.
- 2 If necessary, select **Filter** to see routes only or Auto Guidance paths only.
- 3 Select **Sort** to sort the list of available routes by range, length, or name.

Editing a Saved Route

You can change the name of a route or change the turns the route contains.

- 1 Select **Where To > Routes**.

- 2 Select a route.
- 3 Select **Review > Edit Route**.
- 4 Select an option:
 - To change the name, select **Name**, and enter the name.
 - To edit a turn from a list, select **Edit Turns > Use Turn List**, and select a turn from the list.
 - To select a turn using the chart, select **Edit Turns > Use Chart**, and select a location on the chart.

Modifying a turn that uses a saved waypoint does not move that waypoint, it relocates the turn in the route. Moving the location of a waypoint used in a route does not move the turn in the route.

Finding and Navigating a Saved Route

Before you can browse a list of routes and navigate to one of them, you must create and save at least one route (*Creating and Saving a Route, page 60*).

- 1 Select **Where To > Routes**.
- 2 Select a route.
- 3 Select **Navigate To**.
- 4 Select an option:
 - To navigate the route from the starting point used when the route was created, select **Forward**.
 - To navigate the route from the destination point used when the route was created, select **Backward**.
 - To navigate parallel to the route, select **Offset** (*Browsing for and Navigating Parallel to a Saved Route, page 61*).
 - To navigate a route from the route's first waypoint, select **From Start**.

A magenta line appears. In the center of the magenta line is a thinner purple line that represents the corrected course from your present location to the destination. The corrected course is dynamic, and it moves with your boat when you are off course.

- 5 Review the course indicated by the magenta line.
- 6 Follow the magenta line along each leg in the route, steering to avoid land, shallow water, and other obstacles.
- 7 If you are off course, follow the purple line (corrected course) to go to your destination, or steer back to the magenta line (direct course).

Browsing for and Navigating Parallel to a Saved Route

Before you can browse a list of routes and navigate to one of them, you must create and save at least one route (*Creating and Saving a Route, page 60*).

- 1 Select **Where To > Routes**.
Auto Guidance is available with premium charts, in some areas.
- 2 Select a route.
- 3 Select **Navigate To**.
- 4 Select **Offset** to navigate parallel to the route.
- 5 Select **Offset** to enter the distance to offset from the route.
- 6 Indicate how to navigate the route:
 - To navigate the route from the starting point used when the route was created, to the left of the original route, select **Forward - Port**.
 - To navigate the route from the starting point used when the route was created, to the right of the original route, select **Forward - Starboard**.
 - To navigate the route from the destination point used when the route was created, to the left of the original route, select **Backward - Port**.
 - To navigate the route from the destination point used when the route was created, to the right of the original route, select **Backward - Starboard**.

- 7 If necessary, select **Done**.
A magenta line appears. In the center of the magenta line is a thinner purple line that represents the corrected course from your present location to the destination. The corrected course is dynamic, and it moves with your boat when you are off course.

- 8 Review the course indicated by the magenta line.
- 9 Follow the magenta line along each leg in the route, steering to avoid land, shallow water, and other obstacles.

- 10 If you are off course, follow the purple line (corrected course) to go to your destination, or steer back to the magenta line (direct course).

Initiating a Search Pattern

You can initiate a search pattern to search an area. Different patterns are better suited for different search situations.

- 1 Select **Where To > Routes > New > Route Using SAR Pattern**.
- 2 Select a pattern:
 - Select **Sector Search** when the location of the object is fairly known, the search area is small, and an intensive search is needed.
 - Select **Expanding Square** when the location of the object is somewhat doubtful, the search area is small, and an intensive search is needed.
 - Select **Creeping/Parallel Line** when the location of the object is approximate, the search area is small, and a consistent search is needed.
- 3 Enter the search parameters.
- 4 Select **Done**.
- 5 If necessary, select **Engage**.

Deleting a Saved Route

- 1 Select **Where To > Routes**.
- 2 Select a route.
- 3 Select **Review > Delete**.

Deleting All Saved Routes

Select **Where To > Manage User Data > Delete User Data > Routes**.

Auto Guidance

WARNING

The Auto Guidance feature is based on electronic chart information. That data does not ensure obstacle and bottom clearance. Carefully compare the course to all visual sightings, and avoid any land, shallow water, or other obstacles that may be in your path.

All route and navigation lines displayed on the chartplotter are only intended to provide general route guidance or to identify proper channels, and are not intended to be precisely followed. Always defer to the nav aids and conditions on the water when navigating to avoid groundings or hazards that could result in vessel damage, personal injury, or death.

NOTE: Auto Guidance is available with premium charts, in some areas.

You can use Auto Guidance to plot the best path to your destination. Auto Guidance uses your chartplotter to scan chart data, such as water depth and known obstacles, to calculate a suggested path. You can adjust the path during navigation.

Setting and Following an Auto Guidance Path

- 1 Select a destination (*Destinations, page 57*).
- 2 Select **Navigate To > Auto Guidance**.
- 3 Review the path, indicated by the magenta line.
- 4 Select **Start Navigation**.
- 5 Follow the magenta line, steering to avoid land, shallow water, and other obstacles (*Route Color Coding, page 57*).

NOTE: When using Auto Guidance, a gray segment within any part of the magenta line indicates that Auto Guidance cannot calculate part of the Auto Guidance line. This is due to the settings for minimum safe water depth and minimum safe obstacle height.

Creating and Saving an Auto Guidance Path

- 1 Select **Where To > Routes > New > Auto Guidance**.
- 2 Select a starting point, and select **Next**.
- 3 Select a destination, and select **Next**.
- 4 Select an option:

- To view a hazard and adjust the path near a hazard, select **Hazard Review**.
- To adjust the path, select **Adjust Path**, and follow the on-screen instructions.
- To delete the path, select **Cancel Auto Guidance**.
- To save the path, select **Done**.

Adjusting a Saved Auto Guidance Path

- 1 Select **Where To > Routes & Auto Guidance**.
- 2 Select a path, and select **Review > Edit > Adjust Path**.

TIP: When navigating an Auto Guidance path, select the path on the navigation chart, and select Adjust Path.

- 3 Select a location on the path.
- 4 Drag the point to a new location.
- 5 If necessary, select a point, and select **Remove**.
- 6 Select **Done**.

Canceling an Auto Guidance Calculation in Progress

From the Navigation chart, select **Options > Cancel**.

TIP: You can select Back to quickly cancel the calculation.

Setting a Timed Arrival

You can use this feature on a route or an Auto Guidance path to get feedback about when you should arrive at a selected point. This allows you to time your arrival at a location, such as a bridge opening or a race starting line.

- 1 From the Navigation chart, select **Options**.
- 2 Select **Navigation Options > Timed Arrival**.

TIP: You can quickly open the Timed Arrival menu by selecting a point on the path or route.

Auto Guidance Path Configurations

CAUTION

The Preferred Depth and Vertical Clearance settings influence how the chartplotter calculates an Auto Guidance path. If a section of an Auto Guidance path is shallower than the Preferred Depth or lower than the Vertical Clearance settings, the section of the Auto Guidance path appears as a solid orange line or a red striped line in Garmin Navionics+™ and Garmin Navionics Vision+™ charts and appears as a magenta and gray striped line in previous versions. When your boat enters one of those areas, a warning message appears ([Route Color Coding, page 57](#)).

NOTE: Auto Guidance is available with premium charts, in some areas.

Not all settings apply to all maps.

You can set the parameters the chartplotter uses when calculating an Auto Guidance path.

Select  > **Preferences > Navigation > Auto Guidance**.

Preferred Depth: Sets the minimum water depth, based on chart depth data, that your boat can safely travel over.

NOTE: The minimum water depth for the premium charts (made before 2016) is 3 feet. If you enter a value of less than 3 feet, the charts only use depths of 3 feet for Auto Guidance path calculations.

Vertical Clearance: Sets the minimum height of a bridge or obstacle, based on chart data, that your boat can safely travel under.

Shoreline Distance: Sets how close to the shore you want the Auto Guidance path to be placed. The path may move if you change this setting while navigating. The available values for this setting are relative, not absolute. To ensure that path is placed the appropriate distance from shore, you can assess the placement of the path using one or more familiar destinations that require navigation through a narrow waterway ([Adjusting the Distance from Shore, page 63](#)).

Adjusting the Distance from Shore

The Shoreline Distance setting indicates how close to the shore you want the Auto Guidance line to be placed. The Auto Guidance line may move if you change this setting while navigating. The available values for the Shoreline Distance setting are relative, not absolute. To ensure the Auto Guidance line is placed the appropriate distance from shore, you can assess the placement of the Auto Guidance line using one or more familiar destinations that require navigation through a narrow waterway.

- 1 Dock your vessel or drop the anchor.
- 2 Select  > **Preferences > Navigation > Auto Guidance > Shoreline Distance > Normal**.

- 3 Select a destination that you have navigated to previously.
- 4 Select **Navigate To > Auto Guidance**.
- 5 Review the placement of the **Auto Guidance** line, and determine whether the line safely avoids known obstacles and the turns enable efficient travel.
- 6 Select an option:
 - If the placement of the line is satisfactory, select **Options > Navigation Options > Stop Navigation**, and proceed to step 10.
 - If the line is too close to known obstacles, select **⚙️ > Preferences > Navigation > Auto Guidance > Shoreline Distance > Far**.
 - If the turns in the line are too wide, select **⚙️ > Preferences > Navigation > Auto Guidance > Shoreline Distance > Near**.
- 7 If you selected **Near** or **Far** in step 6, review the placement of the **Auto Guidance** line, and determine whether the line safely avoids known obstacles and the turns enable efficient travel.
 Auto Guidance maintains a wide clearance from obstacles in open water, even if you set the Shoreline Distance setting to Near or Nearest. As a result, the chartplotter may not reposition the Auto Guidance line, unless the destination selected requires navigation through a narrow waterway.
- 8 Select an option:
 - If the placement of the line is satisfactory, select **Options > Navigation Options > Stop Navigation**, and proceed to step 10.
 - If the line is too close to known obstacles, select **⚙️ > Preferences > Navigation > Auto Guidance > Shoreline Distance > Farthest**.
 - If the turns in the line are too wide, select **⚙️ > Preferences > Navigation > Auto Guidance > Shoreline Distance > Nearest**.
- 9 If you selected **Nearest** or **Farthest** in step 8, review the placement of the **Auto Guidance** line, and determine whether the line safely avoids known obstacles and the turns enable efficient travel.
 The Auto Guidance path maintains a wide clearance from obstacles in open water, even if you set the Shoreline Distance setting to Near or Nearest. As a result, the chartplotter may not reposition the Auto Guidance line, unless the destination selected requires navigation through a narrow waterway.
- 10 Repeat steps 3 through 9 at least once more, using a different destination each time, until you are familiar with the functionality of the **Shoreline Distance** setting.

Tracks

A track is a recording of the path of your boat. The track currently being recorded is called the active track, and it can be saved. You can show tracks in each chart or 3D chart view.

Showing Tracks

- 1 From a chart, select **Options > Layers > Manage User Data > Tracks**.
- 2 Select the tracks to display.
 A trailing line on the chart indicates your track.

Setting the Color of the Active Track

- 1 Select **Where To > Tracks > Active Track Options > Track Color**.
- 2 Select a track color.

Saving the Active Track

The track currently being recorded is called the active track.

- 1 Select **Where To > Tracks > Save Active Track**.
- 2 Select an option:
 - Select the time the active track began.
 - Select **Entire Log**.
- 3 Select **Save**.

Viewing a List of Saved Tracks

Select **Where To > Tracks > Saved Tracks**.

Editing a Saved Track

- 1 Select **Where To > Tracks > Saved Tracks**.

- 2 Select a track.
- 3 Select **Review > Edit Track**.
- 4 Select an option:
 - Select **Name**, and enter the new name.
 - Select **Track Color**, and select a color.
 - Select **Save as Route** to save the track as a route.
 - Select **Save as Boundary** to save the track as a boundary.

Saving a Track as a Route

- 1 Select **Where To > Tracks > Saved Tracks**.
- 2 Select a track.
- 3 Select **Review > Edit Track > Save as Route**.

Browsing for and Navigating a Recorded Track

Before you can browse a list of tracks and navigate to them, you must record and save at least one track.

- 1 Select **Where To > Tracks > Saved Tracks**.
- 2 Select a track.
- 3 Select **Follow Track**.
- 4 Select an option:
 - To navigate the track from the starting point used when the track was created, select **Forward**.
 - To navigate the track from the destination point used when the track was created, select **Backward**.
- 5 Review the course indicated by the colored line.
- 6 Follow the line along each leg in the route, steering to avoid land, shallow water, and other obstacles.

Deleting a Saved Track

- 1 Select **Where To > Tracks > Saved Tracks**.
- 2 Select a track.
- 3 Select **Review > Delete**.

Deleting All Saved Tracks

Select **Where To > Manage User Data > Delete User Data > Saved Tracks**.

Retracing the Active Track

The track currently being recorded is called the active track.

- 1 Select **Where To > Tracks > Follow Active Track**.
- 2 Select an option:
 - Select the time the active track began.
 - Select **Entire Log**.
- 3 Review the course indicated by the colored line.
- 4 Follow the colored line, steering to avoid land, shallow water, and other obstacles.

Clearing the Active Track

Select **Where To > Tracks > Clear Active Track**.

The track memory is cleared, and the active track continues to be recorded.

Managing the Track Log Memory During Recording

- 1 Select **Where To > Tracks > Active Track Options**.
- 2 Select **Record Mode**.
- 3 Select an option:
 - To record a track log until the track memory is full, select **Fill**.
 - To continuously record a track log, replacing the oldest track data with new data, select **Wrap**.

Configuring the Recording Interval of the Track Log

You can indicate the frequency at which the track plot is recorded. Recording more frequent plots is more accurate but fills the track log faster. The resolution interval is recommended for the most efficient use of memory.

- 1 Select **Where To > Tracks > Active Track Options > Interval > Interval**.
- 2 Select an option:
 - To record the track based on a distance between points, select **Distance > Change**, and enter the distance.
 - To record the track based on a time interval, select **Time > Change**, and enter the time interval.
 - To record the track plot based on a variance from your course, select **Resolution > Change**, and enter the maximum error allowed from the true course before recording a track point. This is the recommended recording option.

Boundaries

WARNING

This feature is a tool for situational awareness only and may not prevent groundings or collisions in all circumstances. It is your obligation to ensure safe operation of your vessel.

CAUTION

The Beeper setting must be turned on to make alarms audible (*Sounds and Display Settings, page 200*). Failure to set audible alarms could lead to injury or property damage.

Boundaries allow you to avoid or remain in designated areas in a body of water. You can set an alarm to alert you when you enter or exit a boundary.

You can create boundary areas, lines, and circles using the map. You can also convert saved tracks and routes into boundary lines. You can create a boundary area using waypoints by creating a route from the waypoints, and converting the route into a boundary line.

You can select a boundary to act as the active boundary. You can add the active boundary data to the data fields on the chart.

Creating a Boundary

- 1 Select **Where To > Boundaries > New**.
- 2 Select a boundary shape.
- 3 Follow the on-screen instructions.

Converting a Route to a Boundary

- 1 Select **Where To > Routes**.
- 2 Select a route.
- 3 Select **Review > Edit Route > Save as Boundary**.

Converting a Track to a Boundary

- 1 Select **Where To > Tracks > Saved Tracks**.
- 2 Select a track.
- 3 Select **Review > Edit Track > Save as Boundary**.

Editing a Boundary

- 1 Select **Where To > Boundaries**.
- 2 Select a boundary.
- 3 Select **Review**.
- 4 Select an option:
 - To edit the appearance of the boundary on the chart, select **Display Options**.
 - To change the boundary lines or name, select **Edit Boundary**.
 - To edit the boundary alarm, select **Alarm**.

Linking a Boundary to a SmartMode™ Layout

You can link a boundary to a SmartMode layout to automatically open the layout when entering or exiting the boundary. For example, you can set a boundary around your marina, and automatically open the Docking layout when you approach the marina.

- 1 Select **Where To > Manage User Data > Boundaries**.
- 2 Select a boundary.
- 3 Select **Review > Link SmartMode™ > SmartMode™**.

- 4 Select **Entering**, and select a layout.
- 5 Select **Exiting**, and select a layout.

Setting a Boundary Alarm

Boundary alarms alert you when you are within a specified distance of a set boundary. This can be helpful when attempting to avoid certain areas or when you should be very alert in certain areas.

- 1 Select **Where To > Boundaries**.
- 2 Select a boundary.
- 3 Select **Review > Alarm**.
- 4 Select an option:
 - To set an alarm for when your boat is a specified distance from the boundary, select **Warning Dist.**, enter a distance, and select **Done**.
 - To set an alarm for when you enter or exit an area boundary or a circle boundary, select **Area** to show **Entering** or **Exiting**.

Disabling all Boundary Alarms

Select **Where To > Manage User Data > Boundaries > Alarms**.

Deleting a Boundary

- 1 Select **Where To > Boundaries**.
- 2 Select a boundary.
- 3 Select **Review > Edit Boundary > Delete**.

Deleting All Saved Waypoints, Tracks, Routes, and Boundaries

Select **Where To > Manage User Data > Delete User Data > Delete All User Data > OK**.

Using the Starting Line Guidance

You can use the starting line guidance feature to help get you cross the start line, at the optimal speed during a sailing race.

- 1 Mark the starting line (*Setting the Starting Line, page 69*).
- 2 From the Sail Racing combination screen, select **Options > Start Line Guidance > Target Speed**, and select your target speed when crossing the starting line.
TIP: You do not have to set your target speed if you have loaded a polar table (*Polar Tables, page 70*).
- 3 Select **Target Time**, and select the target time to cross the starting line.
- 4 Select **Back**.
- 5 Start the racing timer (*Starting the Race Timer, page 69*).

Setting the Starting Line

The start line guidance window is added to the Sail Racing combination screen by default.

- 1 From the Sail Racing combination screen, select **Options > Start Line Guidance > Start Line**.
- 2 Select an option:
 - To mark the port and starboard starting line marks as you sail past them, select **Ping Marks**.
 - To mark the port and starboard starting line marks by entering their coordinates, select **Enter Coordinates**.
 - To switch the position of the port and starboard marks after you have set them, select **Swap Port & Starbd.**

If you are not located near the starting line and do not know the coordinates, you can set the starting line using the chart.

Setting the Starting Line from the Navigation Chart

If you are not located near the starting line and do not know its coordinates, or if you know the landmarks associated with the starting line, you can set the starting line by establishing points on the chart.

- 1 From the Navigation Chart, touch any location to open the banner on the top of the chart.
- 2 In the banner, select **Start Line**.
- 3 Select an option to define one of the end points for the starting line:
 - Touch or drag to a point on the map using a landmark or other identifying chart feature.
 - If you know the distance and bearing from your location, select **Enter Range/Bearing** and enter the values for the range and bearing from your location on the chart.
- 4 Select **Select Port Mark** or **Select Starboard Mark** to define the first point of the starting line.
- 5 Select an option to define the other end point for the starting line:
 - Touch or drag to a point on the map using a landmark or other identifying chart feature.
 - If you know the distance and bearing from one starting point to the other, select **Enter Range/Bearing** and enter the values for the range and bearing.
- 6 Select **Select Port Mark** or **Select Starboard Mark** to define the second point of the starting line.
TIP: If you accidentally selected the wrong label for the port and starboard points, you can select **Swap Port & Starbd.** to change them.
- 7 Select **Done**.

Starting the Race Timer

The race timer is added to the Sail Racing combination screen by default.

- 1 From the Sail Racing combination screen, select **Start**.
You can also access this from the Sailing SmartMode™ screen and the navigation chart.
- 2 When necessary, select **Sync** to synchronize with the official race timer.

Stopping the Race Timer

From the Sail Racing combination screen, select **Stop**.

Setting the Distance between the Bow and the GPS Antenna

You can enter the distance between the bow of your boat and the location of your GPS antenna. This helps ensure the bow of your boat crosses the starting line at the precise start time.

- 1 From the Sail Racing combination screen, select **Options > Start Line Guidance > Start Line > GPS Bow Ofst.**
- 2 Enter the distance.

3 Select Done.

Sailing Navigation Chart Presets

You can select a sailing-specific preset on the navigation chart to quickly adjust chart elements such as laylines and the wind rose to display the information most relevant to your needs in specific situations. These presets behave in the same way as other chart presets, but are available only when using a sailing vessel ([Presets, page 26](#)).

Sailing: Laylines, Points of Interest (POIs), and the wind rose are all shown. The chart is set to north up orientation.

Sail Racing: Laylines and the wind rose are shown, but POIs are hidden. The chart is set to north up orientation.

Motoring: Laylines and the wind rose are hidden, but POIs are shown. The chart is set to head up orientation.

SmartMode™ Layouts for Sailing

You can select a preconfigured SmartMode layout to quickly show sailing information relevant to your needs in specific situations, such as Docking and Sail Racing.

The information shown on the SmartMode layouts for sailing depend on the type of SmartMode selected and the number of associated display devices in the station.

TIP: When selecting a SmartMode layout, the  icon on the button indicates that the SmartMode layout uses a sailing chart preset on the navigation chart.

Laylines Settings

To use the laylines features, you must connect a wind sensor to the chartplotter.

When in sailing mode ([Setting the Vessel Type for Sailing Features, page 68](#)), you can display laylines on the navigation chart. Laylines can be very helpful when racing.

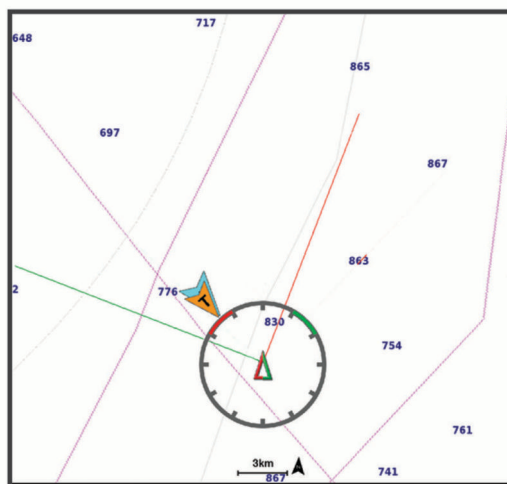

From the Navigation chart, select **Options > Layers > My Vessel > Laylines > Setup**.

Sailing Ang.: Allows you to select how the device calculates laylines. The Actual option calculates the laylines using the measured wind angle from the wind sensor. The Manual option calculates the laylines using manually entered windward and leeward angles. The Polar Table option calculates the laylines based on the imported polar table data ([Importing a Polar Table Manually, page 71](#)).

Windward Ang.: Allows you to set a layline based on the windward sailing angle.

Leeward Ang.: Allows you to set a layline based on the leeward sailing angle.

Layline Filter: Filters the layline data based on the time interval entered. For a smoother layline that filters out some of the changes in the boat's heading or true wind angle, enter a higher number. For laylines that display a higher sensitivity to changes in the boat's heading or true wind angle, enter a lower number.

Polar Tables

WARNING

This feature allows you to load and use data from a third party. Garmin® makes no representations about the accuracy, reliability, completeness or timeliness of the data generated by third parties. Any use or reliance on data generated by third parties is at your own risk.

You can use polar table data with your chartplotter. You can assign polar data types in data fields, and you can use polar data to calculate optimal laylines and starting line guidance.

The chartplotter is preloaded with a set of polar table data you can use. You can also upload a custom polar-table data file.

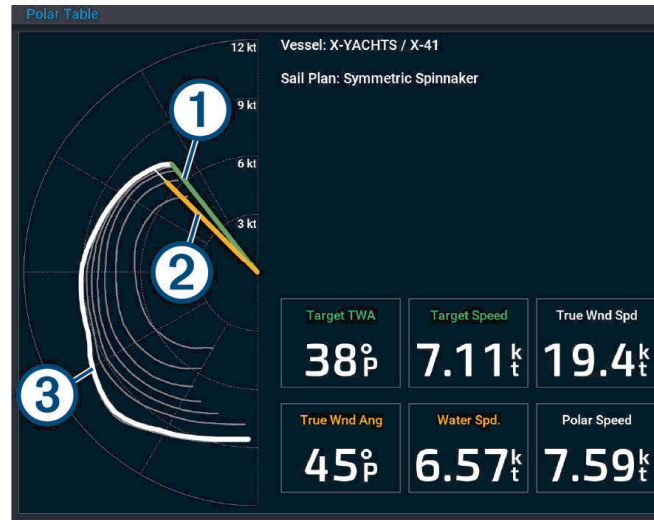

①	Target wind speed and angle, where the length of the line indicates the speed
②	Measured speed and angle, the length of the line indicates the speed
③	Curve from the polar table that matches the measured wind speed

Selecting a Preloaded Polar Table

You can select from a number of polar tables preloaded on the chartplotter.

- 1 Select **⚙** > **My Vessel** > **Polar Table** > **Select Polar Table**.
- 2 Select a polar table from the list.

Importing a Polar Table Manually

If you save the polar table file as polar.plr and place it in the Garmin/polars/ folder on the memory card, the chartplotter imports the data automatically after you insert the memory card. If it does not import the data automatically, or if you want to load a different set of data, you can initiate the import manually.

- 1 Save the polar table as a .plr file in the Garmin/polars/ folder on the memory card.
- 2 Insert the memory card containing the polar data file into the chartplotter ([Memory Cards, page 18](#)).
- 3 Select **⚙** > **My Vessel** > **Polar Table** > **Select Polar Table** > **Import from Card**.
- 4 If necessary, select the card slot and the polar table file.

After the polar table is imported, you can remove the memory card.

If you need to import a different set of polar tables based on your sailing plans or conditions, you must manually import the new polar-table data. The chartplotter supports one set of data at a time.

Viewing Polar Table Details

After you have selected or loaded a polar table, you can view detailed information about the target wind speed and angles in the polar data.

- 1 Select **⚙** > **My Vessel** > **Polar Table** > **View Details**.
- 2 Select the data you want to view at various points in the polar table.

Showing Polar Data in Data Fields

Before you can view polar data, you must select or import a polar table.

- 1 Open the screen to which you want to add polar data.
- 2 Perform an action.
 - If there is no polar data in a data field and you'd like to add it, select **Options** > **Edit Overlays**, then select the data field where you want to add the data.

- If polar data is present in a data field and you want to change it, press and hold the data field you want to change, then select **Replace Data**.

3 Select **Sailing**.



4 Select the polar data to display in the data field.

- To show the boat speed from the polar table at the current true wind speed and angle, select **Polar Speed**.
- To show the optimal boat speed at the target wind angle, select **Target Speed**.
- To show the optimal wind angle at the current true wind speed, select **Target True Wind Angle**.
- To show Target TWA converted to apparent using target speed, select **Target App. Wind Angle**.
- To show the difference between the current boat speed and the optimal boat speed shown as speed, select **Δ Polar Speed**.
- To show the difference between the current boat speed and the optimal boat speed as a percentage, select **Δ Polar Speed Percent**.
- To show the difference between the current boat speed and the target boat speed shown as speed, select **Δ Target Speed**.
- To show the difference between the current boat speed and the target boat speed shown as a percentage, select **Δ Target Speed Percent**.
- To show the difference between the true wind angle and target true wind angle, select **Δ Target True Wind Angle**.
- To show the difference between the apparent wind angle and target apparent wind angle and the true wind angle, select **Δ Target App. Wind Angle**.

TIP: You can also use the polar table data when calculating laylines and starting line guidance.

Adjusting the Scale of the Polar Table

You can adjust the scale of the polar table to adjust the accuracy for your vessel or to accommodate changes such as replacing or changing the sails. The scale setting reflects across the entire system, so it adjusts all polar table information in data fields and connected devices.

- 1 Select  > **My Vessel** > **Polar Table**.
- 2 Select **Scale Factor**.
- 3 Select , and adjust the scale up or down as needed.

Turning Off Polar Table Data

After you have selected or loaded polar table data, you may want to turn it off so it is not available in the system.

- 1 Select  > **My Vessel** > **Polar Table**.
- 2 Select **Polar Table** to turn off the feature.

You can select Polar Table to turn the feature back on again.

Steer Assist

WARNING

You are responsible for the safe and prudent operation of your vessel. Steer assist is a feature that can provide information on steering your vessel. It does not control the helm for you or relieve you of the responsibility of safely operating your boat. Avoid navigational hazards and never leave the helm unattended.

Steer Assist is a set of sailing features provided to help you steer on the optimal course while sailing. You must select or import a polar table before you can use the Steer Assist feature ([Polar Tables, page 70](#)).

Steer Assist is enabled automatically when you select or load a polar table. To deactivate Steer Assist, select  > **Preferences** > **Navigation** > **Steer Assist**.

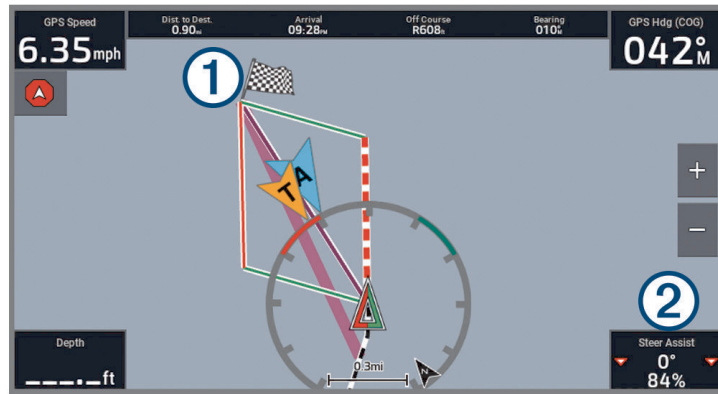

- ① Navigation turn or destination:
 - The wide magenta line indicates the initial route line to the next turn or the destination.
 - The thin purple line from your vessel to the next turn or to the destination indicates your present bearing to the next turn or to the destination.
 - The port and starboard laylines are determined by the polar table you are using.
 - The bold dashed line (can be red, green, or purple) indicates the recommended Steer Assist bearing to follow.
- ② Steer Assist data field:
 - The first number listed indicates how you should turn to align with the suggested optimal course for the present maneuver. A value of 0° indicates that you are on course.
 - The percentage indicates your present speed as compared to the ideal speed for the conditions. If the number is lower than 100%, you should consider adjusting the trim to increase your speed.
 - The triangle or triangles on the side also provide guidance based on the color and shading:
 - A red triangle or triangles indicate that you are aligned with the port layline.
 - A green triangle or triangles indicate that you are aligned with the starboard layline.
 - A magenta triangle or triangles indicate that you are aligned with the bearing to the next turn or destination.
 - A triangle with a white center indicates that you are within 3° of the optimal course and should maintain your heading.
 - A solid triangle or triangles indicate that you are off course by more than 3° and should adjust your heading.

Setting the Keel Offset

You can enter a keel offset to compensate the water depth reading for the transducer installation location. This allows you to view the depth of the water below the keel or the true depth of the water, depending on your needs.

If you want to know the water depth below the keel or the lowest point of your boat and the transducer is installed at the water line or anywhere above the end of the keel, measure the distance from the transducer location to the keel of the boat.

If you want to know the true water depth and the transducer is installed below the water line, measure the distance from the bottom of the transducer up to the water line.

NOTE: This option is only available when you have valid depth data.

1 Measure the distance:

- If the transducer is installed at the water line ① or anywhere above the end of the keel, measure the distance from the transducer location to the keel of the boat. Enter this value as a positive number.
- If the transducer is installed at the bottom of the keel ② and you want to know the true depth of the water, measure the distance from the transducer to the water line. Enter this value in as a negative number.

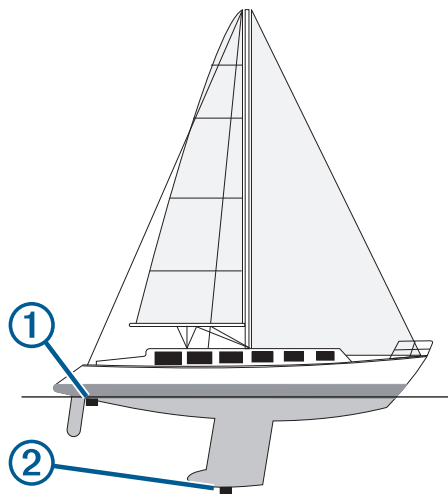

2 Complete an action:

- If the transducer is connected to the chartplotter or a sonar module, select **⚙** > **My Vessel** > **Depth and Anchoring** > **Keel Offset**.
- If the transducer is connected to the NMEA 2000® network, select **⚙** > **Communications** > **NMEA 2000 Setup** > **Device List**, select the transducer, and select **Review** > **Keel Offset**.

3 Select **+** if the transducer is installed at the water line, or select **-** if the transducer is installed at the bottom of the keel.

4 Enter the distance measured in step 1.

Sailboat Autopilot Operation

⚠ WARNING

You are responsible for the safe and prudent operation of your vessel. The autopilot is a tool that enhances your capability to operate your boat. It does not relieve you of the responsibility of safely operating your boat. Avoid navigational hazards and never leave the helm unattended.

⚠ CAUTION



When engaged, the autopilot controls only the rudder. You and your crew remain responsible for the sails while the autopilot is engaged.

In addition to heading hold, you can use the autopilot to maintain a wind hold. You can also use the autopilot to control the rudder while tacking and gybing.

Wind Hold

You can set the autopilot to maintain a specific bearing relative to the apparent or true wind angle. You must connect a compatible wind sensor the same NMEA 2000® network as the autopilot system to perform a wind hold or wind-based steering maneuvers.



①	Autopilot status information Standby and  appear in gray when the autopilot is in standby mode. Wind Hold and  appear in green when the autopilot is engaged in wind hold.
②	Wind gauge Shows the true wind speed (TWS) or apparent wind speed (AWS)
③	Rudder position indicator NOTE: This functionality is available only when a rudder sensor is connected.

Changing the Wind Hold Type

With the wind hold engaged, select **Options > Wind Hold Type**.

The wind hold type changes from Apparent to True, or vice versa.

Engaging Wind Hold

Before you can engage wind hold, you must connect a NMEA 2000® wind sensor to the autopilot.

Although a NMEA 2000 wind sensor is preferred, you can connect a NMEA® 0183 wind sensor to the autopilot to use wind hold.

1 When the autopilot is in standby mode, select **Options**.

2 Select an option:

- To engage an apparent wind hold, select **Engage App. Wind Hold**.
- To engage a true wind hold, select **Engage True Wind Hold**.

TIP: You can quickly engage the last type of wind hold used by selecting Wind Hold from standby mode.

Engaging Wind Hold from Heading Hold

Before you can engage wind hold, you must connect a NMEA 2000® wind sensor to the autopilot.

Although a NMEA 2000 wind sensor is preferred, you can connect a NMEA® 0183 wind sensor to the autopilot to use wind hold.

1 With heading hold engaged, select **Options**.

2 Select an option:

- To change from heading hold to apparent wind hold, select **Engage App. Wind Hold**.
- To change from heading hold to true wind hold, select **Engage True Wind Hold**.

Adjusting the Wind Hold Angle

You can adjust the wind hold angle on the autopilot when wind hold is engaged.

- To adjust the wind hold angle in increments of 1°, select **<1° or 1°>**.

NOTE: Holding **<1° or 1°>** for a few seconds automatically transitions the autopilot from Wind Hold to Heading Hold and initiates rudder steering.

- To adjust the wind hold angle in increments of 10°, select **<<10° or 10°>>**.

You can adjust the settings so that the step turn size is smaller or larger than 10° [Adjusting the Step Steering Increment, page 119](#).

Tack and Gybe

You can set the autopilot to perform a tack or gybe while heading hold or wind hold is engaged.

Tacking and Gybing from Heading Hold

1 Engage a heading hold ([Engaging the Autopilot, page 120](#)).

2 Select **Options**.

3 Select an option.

The autopilot steers your boat through a tack or gybe.

Tacking and Gybing from Wind Hold

Before you can engage wind hold, you must have a wind sensor installed.

1 Engage wind hold ([Engaging Wind Hold, page 75](#)).

2 Select **Options**.

3 Select an option.

The autopilot steers your boat through a tack or gybe, and information about the progress of the tack or gybe appears on the screen.

Setting a Tack Delay

The tack delay allows you to delay steering a tack after you initiate the maneuver.

- 1 From the autopilot screen, select **Options > Autopilot Setup > Sailing Setup > Tack Delay**.
- 2 Select the length of the delay.
- 3 If necessary, select **Done**.

Enabling the Gybe Inhibitor

NOTE: The gybe inhibitor does not prevent you from manually performing a gybe using the helm or step steering.

The gybe inhibitor prevents the autopilot from performing a gybe.

- 1 From the autopilot screen, select **Options > Autopilot Setup > Sailing Setup > Gybe Inhibitor**.
- 2 Select **Enabled**.

Adjusting the Tack and Gybe Speed

You can adjust the turn rate speed when performing tack and gybe maneuvers. You can adjust the speed for each maneuver separately.

- 1 From the autopilot screen, select **Options > Autopilot Setup > Sailing Setup**.
- 2 Select **Tack Speed** or **Gybe Speed**, and adjust the speed.

The higher you set the speed, the faster the turn rate during the maneuver.

NOTE: The turn rate is also affected by the vessel speed.

Heading Line and Angle Markers

The heading line is an extension drawn on the map from the bow of the boat in the direction of travel. Angle markers indicate relative position from the heading or course over ground, which are helpful for casting or finding reference points.

Setting the Heading Line and Angle Markers

The heading line is an extension drawn on the map from the bow of the boat in the direction of travel. Angle markers indicate relative position from the heading or course over ground, which are helpful for casting or finding reference points.

You can show the heading line and the course over ground (COG) line on the chart.

COG is your direction of movement. Heading is the direction the bow of the boat is pointed, when a heading sensor is connected.

- 1 From a chart, select **Options > Layers > My Vessel > Heading Line > Angle Markers**.
- 2 If necessary, select **Source**, and select an option:
 - To automatically use the available source, select **Auto**.
 - To use the GPS antenna heading for COG, select **GPS Heading (COG)**.
 - To use data from a connected heading sensor, select **Heading**.
 - To use data from both a connected heading sensor and the GPS antenna, select **COG and Heading**.
This displays both the heading line and the COG line on the chart.
- 3 Select **Display**, and select an option:
 - Select **Distance > Distance**, and enter the length of the line shown on the chart.
 - Select **Time > Time**, and enter the time used to calculate the distance your boat will travel in the specified time at your present speed.

Viewing Sailing Vessel Data

After you have connected a compatible device, such as the MSC™ 10 compass, you can view vessel data, such as heave, pitch, and heel.

- 1 Select an option based on the type of screen you are viewing:
 - From a full screen view, select **Options > Edit Overlays**.
 - From a combination screen, select **Options > Edit Combo > Overlays**.
 - From a SmartMode™ screen, select **Options > Edit Layout > Overlays**.

TIP: To quickly change the data shown in an overlay box, hold the overlay box.
- 2 Select **Data**.
- 3 Select the data to add to the page, such as **Heave, Trim (Pitch),** or **Heel Angle**.

Sonar Fishfinder

When properly connected to a transducer, your compatible chartplotter can be used as a fishfinder. Chartplotter models without an xsv or xs in their names require a Garmin® sonar module and transducer to display sonar information.

For more information about which transducer is best for your needs, go to garmin.com/transducers.

Different sonar views can help you view the fish in the area. The sonar views available vary depending on the type of transducer and sonar module connected to the chartplotter. For example, you can view certain Panoptix™ sonar screens only if you have a compatible Panoptix transducer connected.

There are four basic styles of sonar views available: a full-screen view, a split-screen view that combines two or more views, a split-zoom view, and a split-frequency view that displays two different frequencies. You can customize the settings for each view in the screen. For example, if you are viewing the split-frequency view, you can separately adjust the gain for each frequency.

If you do not see an arrangement of sonar views to suit your needs, you can create a custom combination screen (*Creating a New Combination Page*, page 24). You can also add sonar views to SmartMode™ layouts (*Adding a SmartMode™ Layout*, page 24).

Stopping the Transmission of Sonar Signals

- To disable the active sonar, from the sonar screen, select **Options > Transmit**.
- To disable all sonar transmissions, press , and select **Disable All Sonar Trans..**

Traditional Sonar View

There are several full-screen views available, depending on the transducer that is connected.

The full-screen Traditional sonar view shows a large image of the sonar readings from a transducer. The range scale along the right side of the screen shows the depth of detected objects as the screen scrolls from the right to the left.

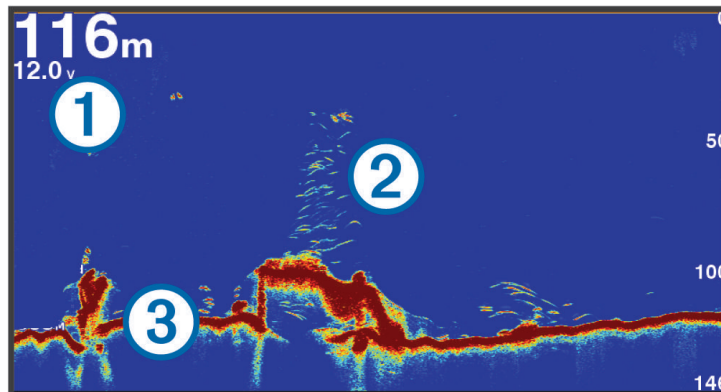

①	Depth information
②	Suspended targets or fish
③	Bottom of the body of water

Split-Frequency Sonar View

In the split-frequency sonar view, the two sides of the screen show a full-view graph of sonar data of different frequencies. You can use this view if you have installed multiple transducers or a transducer that supports multiple frequencies.

NOTE: When using a single-band CHIRP transducer connected to a supported chartplotter or sonar module, the split-frequency sonar view alternates between the two frequencies, which slows the scroll speed. A channel indicator appears next to the sonar frequency on each side of the screen to help identify this behavior.

Garmin ClearVü™ Sonar View

To receive Garmin ClearVü scanning sonar, you need a compatible transducer. For information about compatible transducers, go to garmin.com/transducers.

Garmin ClearVü high-frequency sonar provides a detailed picture of the fishing environment around the boat in a detailed representation of structures the boat is passing over.

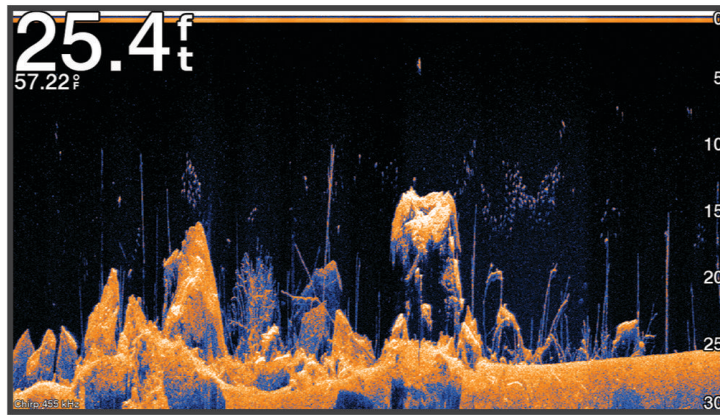

Traditional transducers emit a conical beam. The Garmin ClearVü scanning sonar technology emits a beam similar to the shape of the beam in a copy machine. This beam provides a clearer, picture-like image of what is beneath the boat.

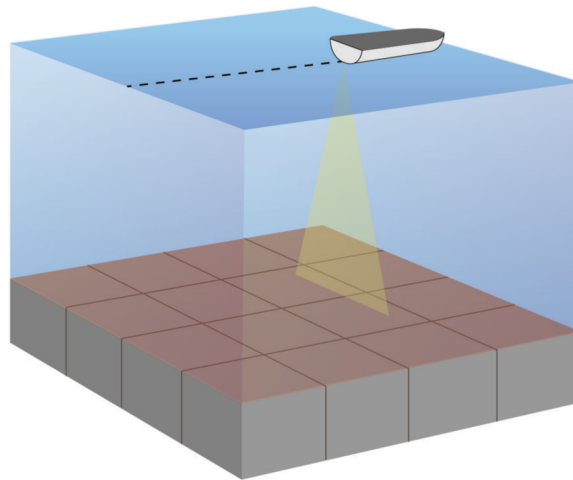

Garmin SideVü™ Sonar View

NOTE: Not all models provide built-in Garmin SideVü sonar support. If your model does not provide built-in SideVü sonar, you need a compatible sonar module and compatible SideVü transducer.

If your model does provide built-in SideVü sonar, you need a compatible SideVü transducer.

SideVü scanning sonar technology shows you a picture of what lies to the sides of the boat. You can use this as a search tool to find structures and fish.

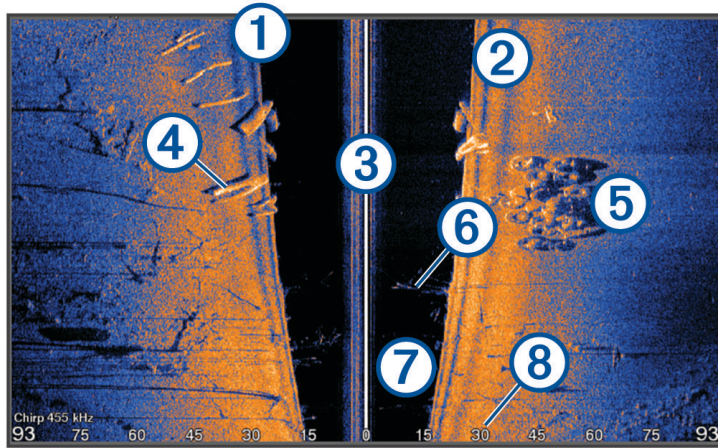

①	Port side of the boat
②	Starboard side of the boat
③	The transducer on your vessel
④	Logs
⑤	Old tires
⑥	Trees
⑦	Water between the vessel and the bottom
⑧	Distance from the side of the boat

SideVü Scanning Technology

Instead of a more common conical beam, the SideVü transducer uses a flat beam to scan the water and bottom to the sides of your boat.

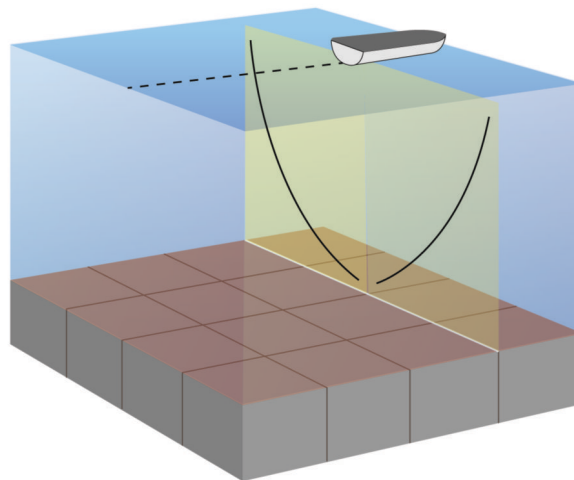

Measuring Distance on the Sonar Screen

You can measure the distance between two points on the SideVü sonar view.

- 1 From the SideVü sonar view, select **■**.
- 2 Select a location on the screen.
- 3 Select **Measure**.

A push pin appears on the screen at the selected location.

4 Select another location.

The distance and angle from the pin is listed in the upper-left corner.

TIP: To reset the pin and measure from the current location of the pin, select Set Reference.

Panoptix™ Sonar Views

To receive Panoptix sonar, you need a compatible transducer.

The Panoptix sonar views allow you to see all around the boat in real time. You can also watch your bait underwater and bait schools in front of or below your boat.

The LiveVü sonar views provide you a view of the live movement either in front of or below your boat. The screen updates very quickly, producing sonar views that look more like live video.

The RealVü 3D sonar views provide three-dimensional views of either what is in front of or below your boat. The screen updates with each sweep of the transducer.

To see all five Panoptix sonar views, you need one transducer to show the down views and a second transducer to show the forward views.

To access the Panoptix sonar views, select Sonar, and select a view.

LiveVü Down Sonar View

This sonar view shows a two-dimensional view of what is below the boat and can be used to see a bait ball and fish.

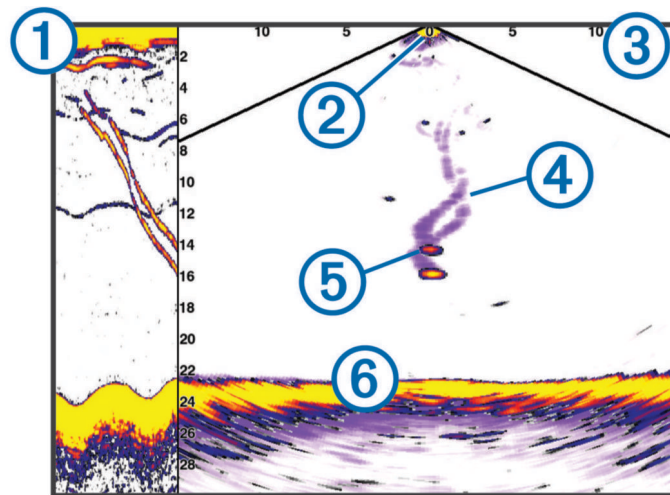

①	Panoptix down view history in a scrolling sonar view
②	Boat
③	Range
④	Trails
⑤	Drop shot rig
⑥	Bottom

LiveVü Forward Sonar View

This sonar view shows a two-dimensional view of what is in front of the boat and can be used to see a bait ball and fish.

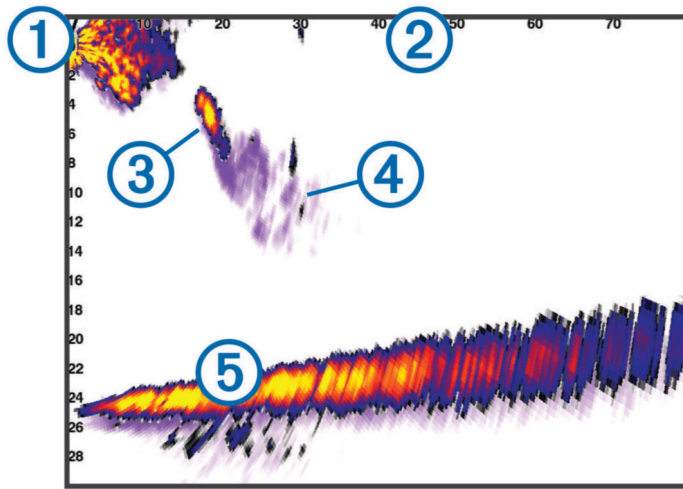

①	Boat
②	Range
③	Fish
④	Trails
⑤	Bottom

RealVü 3D Forward Sonar View

This sonar view shows a three-dimensional view of what is in front of the transducer. This view can be used when you are stationary and you need to see the bottom and the fish approaching the boat.

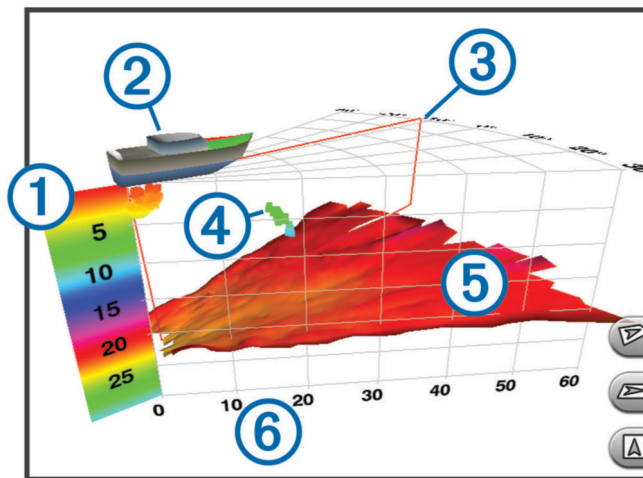

①	Color legend
②	Boat
③	Ping indicator
④	Fish
⑤	Bottom
⑥	Range

RealVü 3D Down Sonar View

This sonar view shows a three-dimensional view of what is below the transducer and can be used when you are stationary and want to see what is around your boat.

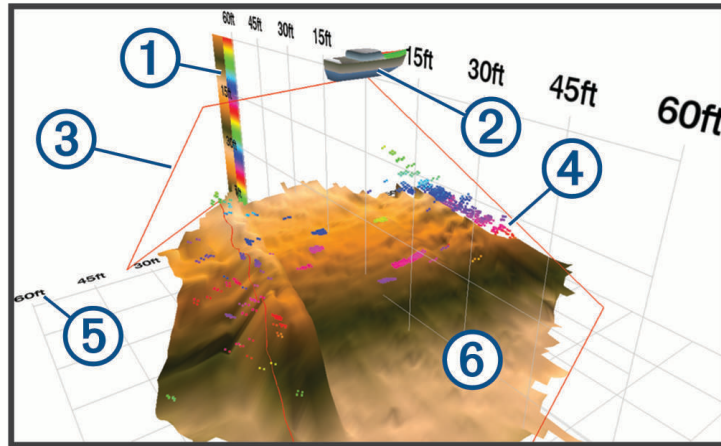

①	Color legend
②	Boat
③	Sonar beam
④	Range
⑤	Fish
⑥	Bottom

RealVü 3D Historical Sonar View

This sonar view provides a three-dimensional view of what is behind your boat as you are moving and shows the entire water column in 3D, from the bottom to the top of the water. This view is used for finding fish.

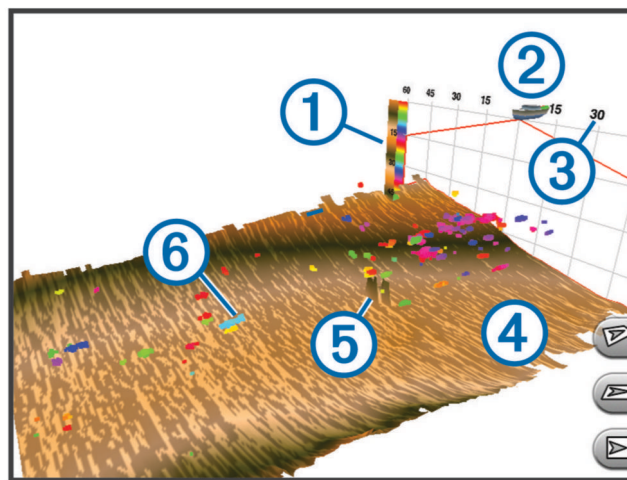

①	Color legend
②	Boat
③	Range
④	Bottom

⑤	Structure
⑥	Fish

LiveVü Layer

You can enable the LiveVü Layer view on the RealVü 3D Historical sonar view only when using a compatible transducer, such as a Panoptix™ PS70-TH.

The LiveVü Layer view adds the LiveVü down view to the RealVü 3D Historical sonar view.

To enable the LiveVü Layer view on the RealVü 3D Historical sonar view, select **Options > LiveVü Layer**.

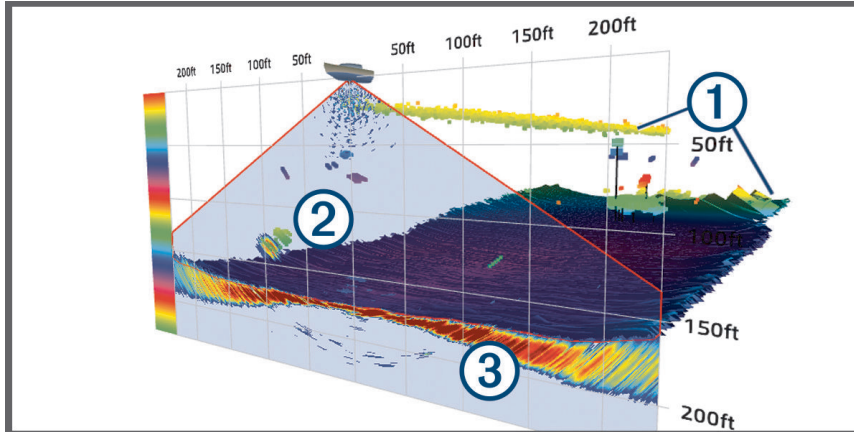

①	RealVü 3D Historical bottom, structure, and fish
②	LiveVü down view structure and fish
③	LiveVü down view bottom

True Motion

You can enable the True Motion feature on the RealVü 3D Historical sonar view only when using a compatible transducer, such as a Panoptix™ PS70-TH.

The True Motion feature on the RealVü 3D Historical sonar view uses data from additional sensors connected to the chartplotter, such as speed and heading sensors, to show a more geographically accurate historical view.

To enable the True Motion feature on the RealVü 3D Historical sonar view, select **Options > True Motion**.

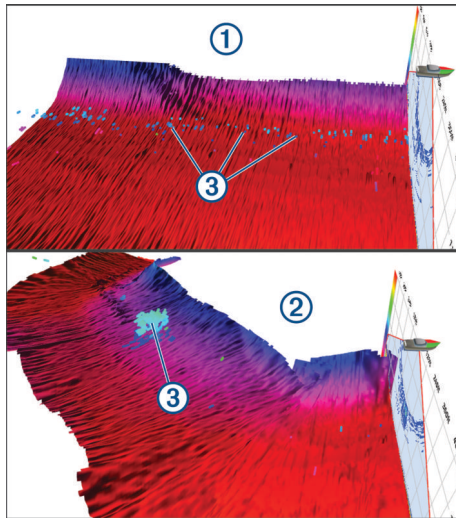

①	Standard RealVü 3D Historical view
②	RealVü 3D Historical view with the True Motion feature enabled
③	Fish

Garmin FrontVü™ Sonar View

The Panoptix Garmin FrontVü sonar view increases your situational awareness by showing obstructions under the water, up to 91 meters (300 feet) in front of the boat.

The ability to effectively avoid forward collisions with Garmin FrontVü sonar decreases as your speed rises above 8 knots.

To see the Garmin FrontVü sonar view, you must install and connect a compatible transducer, such as a PS21 transducer. You may need to update the transducer software.

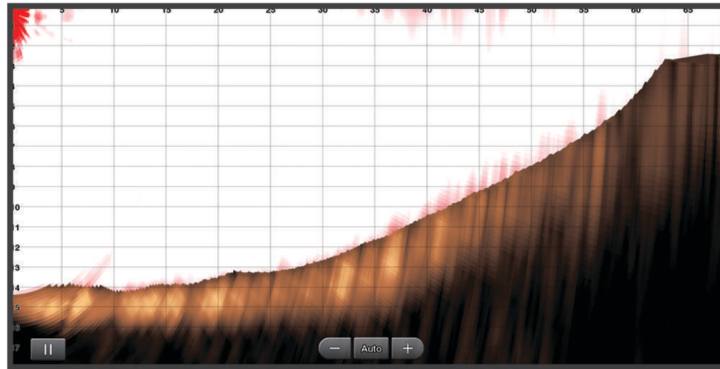

Triple Beam Sonar View

The Triple Beam sonar view is available only when using a compatible transducer, such as the Panoptix™ PS70-TH.

This sonar view shows three traditional sonar views on one screen, so you can simultaneously see separate sonar readings from the port side, the starboard side, and the center of the boat. You can add each separate view to combo pages as needed.

You can adjust the angle and width of the three sonar beams in the Options menu. Other sonar options and settings, such as the sonar Gain, are synchronized across all three views.

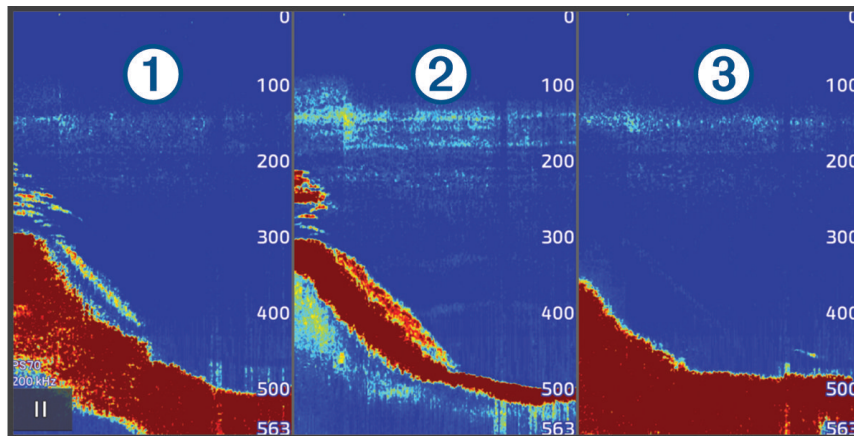

①	Port transducer beam
②	Center transducer beam
③	Starboard transducer beam

LiveScope™ Sonar View

This sonar view shows a live view of what is in front of or below the boat and can be used to see fish and structures.

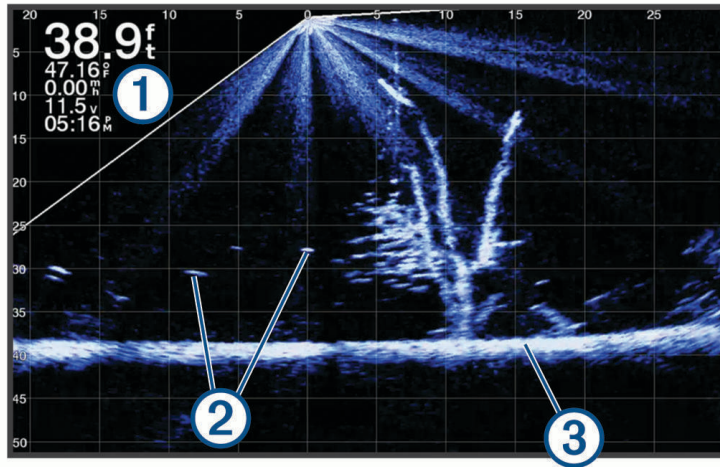

①	Depth information
②	Suspended targets or fish
③	Bottom of the body of water

Zooming in a Panoptix™ LiveVü or LiveScope™ Sonar View

You can zoom in on the Panoptix LiveVü and LiveScope 2D sonar views.

NOTE: The scrolling history is hidden while the screen is in zoom mode.

- 1 From a Panoptix LiveVü or LiveScope 2D sonar view, spread two fingers apart to zoom in on the area. An inset window ① appears and displays a small version of the full-screen image. The boxed area ② in the inset shows the location of the zoomed area.

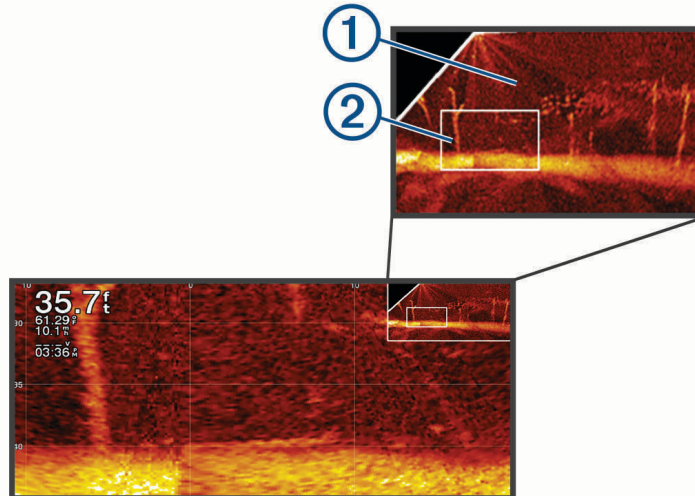

- 2 If necessary, tap or drag within the inset window to view a different area of the full-screen view.
- 3 If necessary, spread two fingers apart to zoom in.
- 4 If necessary, pinch two fingers together to zoom out.

To exit zoom mode, select Back or pinch two fingers together to zoom out until the screen returns to a full-screen view.

Perspective View

This sonar view shows a live view of what is around and ahead of your boat and can be used to see shorelines, fish, and structures. This view is best used in shallow water of 50 feet (15 meters) or less.

To see this sonar view, you must install a compatible LiveScope transducer on compatible a perspective mode mount.

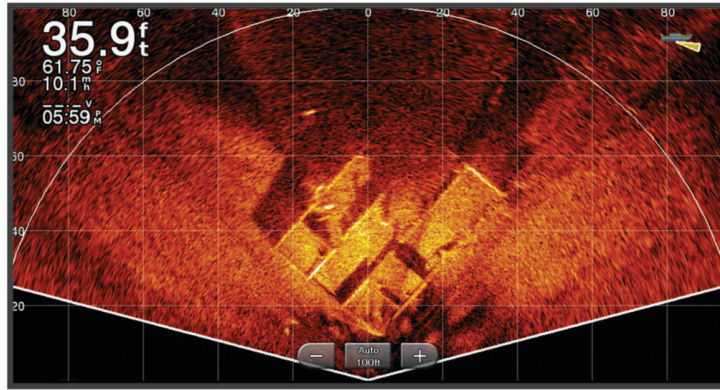

OneVü™ Scanning Sonar

This view captures a 360-degree image of the area under your boat with a single scan, and you can move your boat within the scanned area without having to scan again. You can configure OneVü scanning sonar to scan continuously or automatically when you enter a new area.

To see this sonar view, you must meet these requirements:

- You must install a Spy pole and configure it for your vessel ([Spy Pole Control, page 102](#)).
- You must install a compatible 360-degree sonar transducer, such as the Garmin® GT360UHD transducer, on the end of the Spy pole.
- You must pair the Spy pole with the chartplotter.
- You must assign the 360-degree transducer to the Spy pole ([Configuring a Spy Pole, page 105](#)).

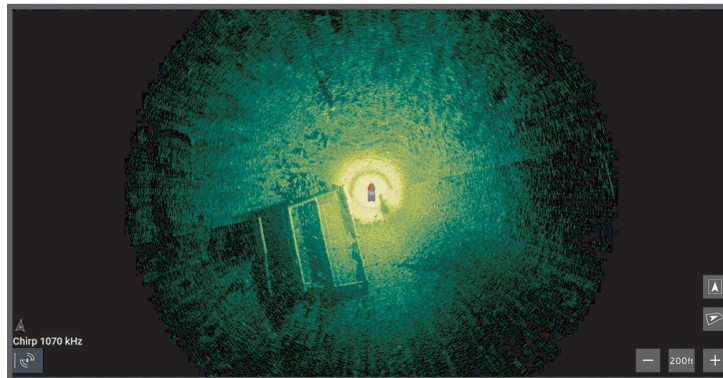

Starting and Stopping OneVü™ Scanning



You can choose when the Spy pole rotates and scans the area under your boat. You can configure the method and speed of the scan ([OneVü™ Sonar Options, page 87](#)).

To start or stop OneVü scanning, select  from the OneVü sonar view, or from the Spy pole control bar.

Interacting with the OneVü™ Sonar View



You can adjust the appearance of the OneVü sonar view as needed using the touchscreen.

From the OneVü sonar view, perform an action:

- To pan to a different area of the sonar view, touch and drag the screen (2D view only).
- To recenter the sonar view, select .
- To zoom in or out on the sonar view, select  and  or pinch in and out on the touchscreen.

Changing Between 2D and 3D Views

By default, the OneVü™ sonar view shows a top-down 360-degree 2D view centered on your vessel. You can change this view to a 3D angle, which allows you to also overlay a LiveScope™ view on the OneVü sonar view if you have both types of transducers connected to a Spy pole.

- Select  to change from the 2D view to the 3D view.
- Select  to change from the 3D view to the 2D view.

OneVü™ Sonar Options

To change the options and settings for the OneVü sonar view, select **Options**.

Contrast: Sets the contrast for the sonar view, which increases the difference between the lightest and darkest areas of the reading.

Brightness: Sets the brightness of the sonar view.

Frequency: Sets the frequency used by the transducer. You can select between Chirp 455 kHz, 810 kHz, and 1070 kHz frequencies based on your needs.

Range: Sets the distance of the range rings on the sonar view.

OneVu™ Scan: Starts and stops OneVü scanning. Select **•••** to adjust the scan settings.

OneVu™ Scan > Scan Mode: Sets the method used to control when the scan runs. Select **Constant** to run the scan continuously. Select **Manual** to scan only when you choose to initiate a new scan. Select **Auto** to engage the scan automatically when the vessel enters a new area.

OneVu™ Scan > Speed: Sets the speed of the scan.

OneVu™ Setup: Sets additional OneVü sonar settings ([OneVü™ Sonar Setup, page 87](#)).

OneVü™ Sonar Setup

From the OneVü sonar view, select **Options > OneVu™ Setup**.

True Motion: (2D view only) Turns on and off the True Motion feature. When on, the OneVü sonar view moves along with your vessel to better show where you are located on the scan.

NOTE: To use the True Motion feature, heading information must be provided to the chartplotter. This can be provided by a Spy heading sensor paired with the Spy pole, or by a heading sensor connected to the same NMEA 2000® network, Garmin BlueNet™ network, or Garmin® Marine Network as the chartplotter.

LiveScope™ Overlay: (3D view only) Turns on and off the LiveScope™ Overlay feature. If you have a LiveScope™ transducer connected to the same Spy pole as the OneVü transducer, you can overlay the LiveScope transducer reading over the 3D OneVü sonar view to add additional information about the area the Spy pole is facing.

NOTE: To use the LiveScope™ Overlay feature, heading and GPS information must be provided to the chartplotter. Heading information can be provided by a Spy heading sensor paired with the Spy pole, or by a heading sensor connected to the same NMEA 2000 network, Garmin BlueNet network, or Garmin Marine Network as the chartplotter. GPS information can be provided by the chartplotter or by an GPS antenna connected to the network.

NOTE: For the LiveScope™ Overlay feature to work correctly, the connected LiveScope transducer must not be configured in the perspective orientation.

Noise Reject: Reduces the interference and the amount of clutter shown on the sonar screen ([Sonar Noise Rejection Settings, page 92](#)).

Appearance: Configures the appearance of the OneVü sonar screen ([OneVü™ Sonar Appearance Settings, page 87](#)).

Alarms: Sets sonar alarms ([Sonar Alarms, page 93](#)).

Installation: Restore defaults.

OneVü™ Sonar Appearance Settings

From the OneVü sonar view, select **Options > OneVu™ Setup > Appearance**.

Color Scheme: Sets the colors used on the sonar view.

Range Rings: Shows and hides the rings on the sonar view indicating the sonar range.

LVS Beam Area: Shows and hides the beam area for the connected LiveScope™ transducer.

Waypoints: Shows and hides any saved waypoints in range of the sonar view.

Orientation: (2D view only) Sets the orientation of the sonar view to show either your heading or north as up.

View Offset: (2D view only) Adjusts the overhead view to the front, back, or either side of the vessel.

Sonar Views in Combo Screens

You can add one or more available sonar views to a custom combination screen ([Creating a New Combination Page, page 24](#)). If more than one source of sonar data is available, you can show sonar screens using different sonar sources in separate windows of a custom combo screen.

If you have more than one source of sonar data available, you are prompted to select the source to use when creating a custom combo. After you create the combo, you can change the source used in a window of the combo screen later ([Selecting a Sonar Source, page 88](#)).

Selecting the Transducer Type

This chartplotter is compatible with a range of accessory transducers, including the Garmin ClearVü™ transducers, which are available at garmin.com/transducers.

If you are connecting a transducer that was not included with the chartplotter, you may need to set the transducer type to make the sonar function properly.

NOTE: Not all chartplotters and sonar modules support this feature.

- 1 Complete an action:
 - From a sonar view, select **Options > Sonar Setup > Installation > Transducers**.
 - Select  > **My Vessel > Transducers**.
- 2 Select the transducer that you want to change, and select **Change Model**.
- 3 Select an option:
 - To enable the chartplotter to detect the transducer automatically, select **Auto Detect**.
 - To select the transducer manually, select the option that matches the installed transducer, such as **Dual Beam (200/77 kHz)** or **Dual Freq (200/50 kHz)**.

NOTICE

Manually selecting a transducer could result in damage to the transducer or reduced transducer performance.

NOTE: If you select the transducer manually, disconnect that transducer, and then connect a different transducer, you should reset this option to **Auto Detect**.

Selecting a Sonar Source

When you have more than one transducer providing data for a particular sonar view, you can select the source to use for that sonar view. For example, if you have two transducers providing Garmin ClearVü™ data, you can select the source to use for the Garmin ClearVü sonar view.

- 1 Open the sonar view for which you will change the source.
 - If the sonar view is in a combo screen, you must select the view you want to change.
- 2 Select **Options > Sonar Setup > Source**.
- 3 Select the source for this sonar view.

Renaming a Sonar Source

You can rename a sonar source to easily identify that source. A sonar source is associated with the chartplotter or sounder module with a connected transducer. For example, you can use "Bow" as the name of the chartplotter installed on the bow of your boat with a connected transducer.

- 1 Select  > **Communications > BlueNet™ Network**.
- 2 Select the chartplotter or sounder module you want to rename.
- 3 Select **Change Name**.
- 4 Enter the name.

Sonar Sharing

You can view the sonar data from all compatible sources on the Garmin BlueNet™ network or Garmin® Marine Network. You can view sonar data from a compatible external sonar module, such as a GCV™ sonar module. In addition, you can view the sonar data from other chartplotters that have a built-in sonar module.

Each chartplotter on the network can display sonar data from every compatible sonar module and transducer on the network, no matter where the chartplotters and transducers are mounted on your boat. For example, from one GPSMAP® 8417 device mounted at the back of the boat, you can view the sonar data from another GPSMAP device and Garmin ClearVü™ transducer mounted at the front of your boat.

When sharing sonar data, the values of some sonar settings, such as Range and Gain, are synchronized across the devices on the network. The values of other sonar settings, such as the Appearance settings, are not synchronized and should be configured on each individual device.

In addition, you can synchronize the scroll rates of the various traditional and Garmin ClearVü sonar views to make the split views more cohesive ([Synchronizing Sonar Scroll Rates, page 89](#)).

NOTE: Using multiple transducers simultaneously can create cross talk, which can be removed by adjusting the Interference sonar setting.

Synchronizing Sonar Scroll Rates

When you have multiple traditional and Garmin ClearVü™ sonar views in a combo screen, you can synchronize the scroll rates to make the split views more cohesive.

- 1 In a combo screen with any combination of traditional and Garmin ClearVü sonar screens, select a sonar screen.
- 2 Select **Options**.
- 3 Select **Sonar Setup** or **ClearVü Setup**.
- 4 Select **Advanced** > **Scroll Sync**.

Pausing and Resuming the Sonar Display

NOTE: Pausing the sonar display affects only the sonar view on the device where you pause the sonar display. The transducer continues to transmit and receive sonar signals, and other connected displays continue to show live sonar data.

From a sonar view, select an option:

- Select **||**.
- Swipe or drag the screen in the direction of the scrolling sonar.

To resume sonar scrolling after pausing, select **▶**.

If you pause a full-screen sonar view that is part of a combo, you can select **Back** to return to the combo screen while the sonar remains paused.

Paused Sonar Considerations

When you pause the sonar display, the system continues to gather sonar information in the background. When you resume sonar scrolling, the sonar data gathered while scrolling was paused is refreshed on the sonar display with a line indicating the point where you paused it.

In most cases, all of the sonar data gathered while it was paused is shown on the screen immediately after you resume scrolling. The location on the graph where you paused scrolling is indicated by a dashed line.

Factors such as the number of sonar windows being viewed, the speed and range of the sonar transmissions, and the capabilities of your chartplotter may reduce the amount of sonar data saved, depending on how long the scrolling was paused. When scrolling is paused longer than the device is able to retain the data, the last recorded point is indicated by a solid line on the graph.

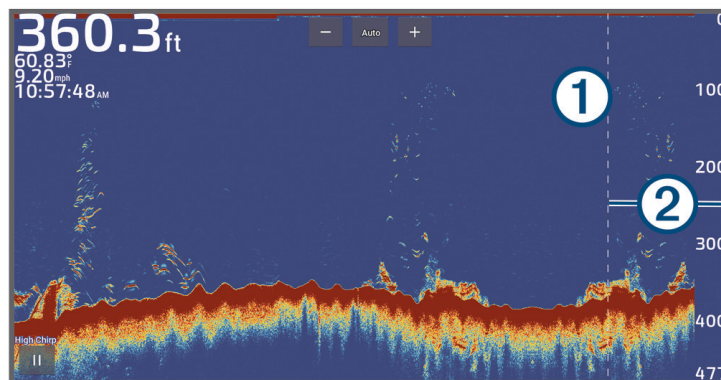

- | | |
|---|---|
| ① | Line indicating when the sonar scrolling was paused: <ul style="list-style-type: none">• Dashed line: the sonar was paused here, and everything to the right of the line was continuously recorded while paused. This line fades after a few seconds upon resuming scrolling, and is not preserved in the sonar history.• Solid line: not all sonar data was continuously recorded due to your system configuration and the duration of the pause. This indicates a break in sonar recording and only data to the right of the line was retained. This line does not fade, and it is preserved in the sonar history. |
| ② | Sonar data gathered while paused. |

Viewing Sonar History

You can scroll the sonar display to view historical sonar data.

NOTE: Not all transducers save historical sonar data.

- 1 From a sonar view, pause the sonar display (*Pausing and Resuming the Sonar Display*, page 89).
- 2 Swipe or drag the screen in the direction of the scrolling sonar to view the history.
- 3 Select ► to exit history and resume sonar scrolling.

Creating a Waypoint on the Sonar Screen

- 1 From a sonar view, pause the sonar display (*Pausing and Resuming the Sonar Display*, page 89).
- 2 If necessary, scroll through the sonar display history until you find the location where you want to create a waypoint.
- 3 Select a location on the sonar view where you want to create the waypoint.
- 4 Select ♥*.
- 5 If necessary, edit the waypoint information.

Adjusting the Level of Detail

You can control the level of detail and noise shown on the sonar screen either by adjusting the gain for traditional transducers or by adjusting the brightness for Garmin ClearVü™ transducers.

If you want to see the highest intensity signal returns on the screen, you can lower the gain or brightness to remove lower intensity returns and noise. If you want to see all return information, you can increase the gain or brightness to see more information on the screen. This also increases noise, and can make it more difficult to recognize actual returns.

- 1 From a sonar view, select **Options**.
- 2 Select **Gain** or **Brightness**.
- 3 Select an option:
 - To increase or decrease the gain or brightness manually, select **Up** or **Down**.
 - To allow the chartplotter to adjust the gain or brightness automatically, select an automatic option.

Adjusting the Color Intensity

You can adjust the intensity of colors and highlight areas of interest on the sonar screen by adjusting the color gain for traditional transducers or the contrast for some transducers. This setting works best after you have adjusted the level of detail shown on the screen using the gain or brightness settings.

If you want to highlight smaller fish targets or create a higher intensity display of a target, you can increase the color gain or contrast setting. This causes a loss in the differentiation of the high intensity returns at the bottom. If you want to reduce the intensity of the return, you can reduce the color gain or contrast.

- 1 From a sonar view, select **Options**.
- 2 Select an option based on sonar view:
 - Select **Contrast**.
 - Select **Sonar Setup > Appearance > Color Gain**.
- 3 Select an option:
 - To increase or decrease the color intensity manually, select **Up** or **Down**.
 - To use the default setting, select **Default**.

Sonar Setup

NOTE: Not all options and settings apply to all models, sonar modules, and transducers.

These settings apply to the following types of transducers.

- Traditional
- Garmin ClearVü™
- SideVü

These settings do not apply to Panoptix™ transducers.

From a sonar view, select **Options > Sonar Setup**.

Scroll Speed: Sets the rate at which the sonar scrolls from right to left (*Setting the Scroll Speed*, page 91).

In shallow water, you can select a slower scroll speed to extend the length of time the information is displayed on screen. In deeper water, you can select a faster scroll speed. Automatic scroll speed adjusts the scrolling speed to the speed the boat is traveling.

Noise Reject: Reduces the interference and the amount of clutter shown on the sonar screen (*Sonar Noise Rejection Settings, page 92*).

Appearance: Configures the appearance of the sonar screen (*Sonar Appearance Settings, page 92*).

Alarms: Sets sonar alarms (*Sonar Alarms, page 93*).

Advanced: Configures various sonar display and data source settings (*Advanced Sonar Settings, page 93*).

Installation: Configures the transducer (*Transducer Installation Settings, page 94*).

Setting the Zoom Level on the Sonar Screen

1 From a sonar view, select **Options > Zoom > ... > Mode**.

2 Select an option:

- To set the depth and zoom automatically, select **Auto**.
If necessary, select **Set Zoom** to modify the zoom setting. Select **View Up** or **View Down** to set the depth range of the magnified area, and select **Zoom In** or **Zoom Out** to increase or decrease the magnification of the magnified area.
- To set the depth range of the magnified area manually, select **Manual**.
If necessary, select **Set Zoom** to modify the zoom setting. Select **View Up** or **View Down** to set the depth range of the magnified area, and select **Zoom In** or **Zoom Out** to increase or decrease the magnification of the magnified area.
- To magnify one particular area of the screen, select **Magnify**.
If necessary, select **Magnify** to increase or decrease the magnification level.
TIP: You can drag the magnification box to a new location on the screen.
- To zoom in on the sonar data from the bottom depth, select **Bottom Lock**.
If necessary, select **Span** to adjust the depth and placement of the bottom lock area.

To cancel the zoom, deselect the Zoom option.

Enabling a Split Zoom Sonar View

When the zoom is set to Auto, Manual, or Bottom Lock, you can enable a split zoom view to show both the standard view and the zoomed-in view side-by-side.

From a sonar view, select **Options > Zoom > ... > Split Zoom**.

To disable the split zoom view, select Split Zoom again.

Setting the Scroll Speed

You can set the rate at which the sonar image moves across the screen. A higher scroll speed shows more detail until there is no additional detail to show, at which point it starts stretching out the existing detail. This can be useful while moving or trolling, or when you are in very deep water where the sonar is pinging very slowly. A lower scroll speed displays sonar information on the screen longer.

For most situations, the Default setting provides a good balance between a quickly scrolling image and less distorted targets.

1 From a sonar view, select **Options > Sonar Setup > Scroll Speed**.

2 Select an option:

- To adjust the scroll speed automatically using speed-over-ground or water speed data, select **Auto**.
The **Auto** setting selects a scroll rate to match the boat speed, so targets in the water are drawn with the correct aspect ratio and appear less distorted. When viewing Garmin ClearVü™/SideVü sonar views or searching for structure, it is recommend to use the **Auto** setting.
- To scroll faster, select **Up**.
- To scroll more slowly, select **Down**.

Adjusting the Range

You can adjust the range of the depth scale for traditional and Garmin ClearVü™ sonar views. You can adjust the range of the width scale for the SideVü sonar view.

Allowing the device to adjust the range automatically keeps the bottom within the lower or outer third of the sonar screen, and can be useful for tracking a bottom that has minimal or moderate terrain changes.

Manually adjusting the range enables you to view a specified range, which can be useful for tracking a bottom that has large terrain changes, such as a drop-offs or cliffs. The bottom can appear on the screen as long as it appears within the range you have set.

1 From a sonar view, select **Options > Range**.

2 Select an option:

- To allow the chartplotter to adjust the range automatically, select **Auto**.
- To increase or decrease the range manually, select **Up** or **Down**.

TIP: From the sonar screen, you can select **+** or **-** to manually adjust the range.

TIP: When viewing multiple sonar screens, you can select **Select** to choose the active screen.

Sonar Noise Rejection Settings

From a sonar view, select **Options > Sonar Setup > Noise Reject**.

Interference: Adjusts the sensitivity to reduce the effects of interference from nearby sources of noise.

The lowest interference setting that achieves the desired improvement should be used to remove interference from the screen. Correcting installation issues that cause noise is the best way to eliminate interference.

Color Limit: Hides part of the color palette to help eliminate fields of weak clutter.

By setting the color limit to the color of the undesired returns, you can eliminate the display of undesired returns on the screen.

Smoothing: Removes noise that is not part of a normal sonar return, and adjusts the appearance of returns, such as the bottom.

When smoothing is set to high, more of the low-level noise remains than when using the interference control, but the noise is more subdued because of averaging. Smoothing can remove speckle from the bottom.

Smoothing and interference work well together to eliminate low-level noise. You can adjust the interference and smoothing settings incrementally to remove undesirable noise from the display.

Surface Noise: Hides surface noise to help reduce clutter. Wider beam widths (lower frequencies) can show more targets, but can generate more surface noise.

TVG: Adjusts the time varying gain, which can reduce noise.

This control is best used for situations when you want to control and suppress clutter or noise near the water surface. It also allows for the display of targets near the surface that are otherwise hidden or masked by surface noise.

Sonar Appearance Settings

From a sonar view, select **Options > Sonar Setup > Appearance**.

Color Scheme: Sets the color scheme.

Color Gain: Adjusts the intensity of colors (*Adjusting the Color Intensity, page 90*).





A-Scope: Displays a vertical flasher along the right side of the screen that shows instantaneously the range to targets along a scale.

Depth Line: Shows a quick-reference depth line.

Edge: Highlights the strongest signal from the bottom to help define the hardness or softness of the signal.

View Selection: Sets the direction of the Garmin SideVü™ sonar view.

Fish Symbols: Sets how the sonar interprets suspended targets.

	Shows suspended targets as symbols and background sonar information.
	Shows suspended targets as symbols with target depth information and background sonar information.
	Shows suspended targets as symbols.
	Shows suspended targets as symbols with target depth information.

Pic. Advance: Allows the sonar picture to advance faster by drawing more than one column of data on the screen for each column of sonar data received. This is especially helpful when you are using the sonar in deep water, because the sonar signal takes longer to travel to the water bottom and back to the transducer.

The 1/1 setting draws one column of information on the screen per sonar return. The 2/1 setting draws two columns of information on the screen per sonar return, and so on for the 4/1 and 8/1 settings.

Echo Stretch: Adjusts the size of the echoes on the screen to make it easier to see separate returns on the screen.

When targets are difficult to see ①, echo stretch makes the target returns more pronounced and easier to see on the screen. If the echo stretch value is too high, the targets blend together. If the value is too low ②, the targets are small and more difficult to see.

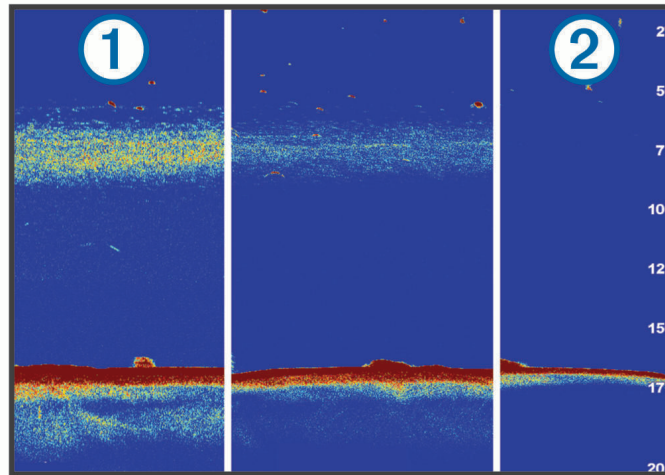

You can use echo stretch and filter width together to obtain the preferable resolution and noise reduction. With echo stretch and filter width set to low, the display has the highest resolution, but is the most susceptible to noise. With echo stretch set to high and filter width set to low, the display has a lower resolution, but has wider targets. With echo stretch and filter width set to high, the display has the lowest resolution, but is the least susceptible to noise. It is not recommended to set echo stretch to low and filter width to high.

Overlay Data: Sets the data shown on the sonar screen.

Sonar Alarms

⚠ WARNING

The sonar alarms feature is a tool for situational awareness only and may not prevent grounding in all circumstances. It is your obligation to ensure safe operation of the vessel.

⚠ CAUTION

The Beeper setting must be turned on to make alarms audible (*Sounds and Display Settings, page 200*). Failure to set audible alarms could lead to injury or property damage.

NOTE: Not all options are available on all transducers.

From an applicable sonar view, select **Options > Sonar Setup > Alarms**.

You can also open the sonar alarms by selecting **⚙ > Alarms > Sonar**.

Shallow Water: Sets an alarm to sound when the depth is less than the specified value.

Deep Water: Sets an alarm to sound when the depth is greater than the specified value.

FrontVü Alarm: Sets an alarm to sound when the depth in front of the vessel is less than the specified value, which can help you avoid running aground (*Setting the Garmin FrontVü™ Depth Alarm, page 97*). This alarm is available only with Panoptix™ Garmin FrontVü™ transducers.

Water Temp.: Sets an alarm to sound when the transducer reports a temperature that is 2°F (1.1°C) above or below the specified temperature.

Contour: Sets an alarm to sound when the transducer reports a water depth below a specified shallow limit or above a specified deep limit. This helps by calling attention when encountering a steep drop-off or a sudden shallow area.

Fish: Sets an alarm to sound when the device detects a suspended target.

- sets the alarm to sound when fish of all sizes are detected.
- sets the alarm to sound only when medium or large fish are detected.
- sets the alarm to sound only when large fish are detected.

Advanced Sonar Settings

From a Traditional sonar view, select **Options > Sonar Setup > Advanced**.

Shift: Allows you to set the depth range on which the sonar is focused. This allows you to zoom in a higher resolution in the focused depth.

When using shift, bottom tracking may not work effectively, because the sonar looks for data within the depth range of the focused area, which may not include the bottom. Using shift also can impact the scroll speed,

because data outside the depth range of the focused area is not processed, which reduces the time required to receive and display the data. You can zoom in to the focused area, which enables you to evaluate target returns more closely at a higher resolution than just zooming alone.

Btm. Srch. Limit: Limits the search for the bottom to the depth selected when the Range setting is set to Auto. To minimize the length of time it takes to find the bottom, you can select a depth to limit the search for the bottom. The device will not search for the bottom deeper than the selected depth.

Range Sync > Off: The range for all sonar views in a combo screen are independent of one another.

Range Sync > On: This setting option is available only when viewing a combo screen using at least two traditional and Garmin ClearVü™ views in a combo screen. The range is synchronized for all traditional and Garmin ClearVü views in the combo screen.

Range Sync > Same Transducer Only: This is the default setting. The ranges are synchronized for views from each transducer in the combo screen, but not between different transducers.

NOTE: This setting does not apply to a dual-band CHIRP transducer.

Scroll Sync: This setting option is available only when viewing a combo screen using at least two traditional and Garmin ClearVüsonar views in a combo screen. The scroll rates are synchronized for all traditional and Garmin ClearVü views in the combo screen.

Transducer Installation Settings

These settings apply to the following types of sonar.

- Traditional
- Garmin ClearVü™
- Garmin SideVü™

From an applicable sonar view, select an option.

- From a Traditional sonar view, select **Options > Sonar Setup > Installation**.
- From a Garmin ClearVü sonar view, select **Options > ClearVü Setup > Installation**.
- From a Garmin SideVü sonar view, select **Options > SideVü Setup > Installation**.

Transmit Rate: Sets the length of time between sonar pings. Increasing the transmit rate increases the scroll speed, but it may also increase self-interference.

Reducing the transmit rate increases the spacing between transmit pulses and can resolve self-interference. This option is available on the Traditional sonar view only.

Transmit Power: Reduces transducer ringing near the surface. A lower transmit power value reduces transducer ringing, but can also reduce the strength of the returns. This option is available on the Traditional sonar view only.

Filter Width: Defines the edges of the target. A shorter filter more clearly defines the edges of the targets but may allow more noise. A longer filter creates softer target edges and may also reduce noise. This option is available on the Traditional sonar view only.

Flip Left/Right: Switches the SideVü view orientation from left to right. This option is available on the SideVü sonar view only.

Restore Sonar Defaults: Restores the sonar settings to the factory default values.

Transducers: View details about installed transducers and save details to a memory card.

Transducers > Change Model: Allows you to change an installed transducer type ([Selecting the Transducer Type, page 88](#)).

Transducers > Manual Configuration: Allows you to set manual transducer configuration parameters on a compatible sonar module. See the installation instructions for your compatible sonar module for more details on connecting and manually configuring a transducer.

Sonar Frequencies

The frequencies available depend on the transducers being used.

Adjusting the frequency helps adapt the sonar for your particular goals and the present depth of the water.

Higher frequencies use narrow beam widths, and are better for high-speed operation and rough sea conditions. Bottom definition and thermocline definition can be better when using a higher frequency.

Lower frequencies use wider beam widths, which can let the fisherman see more targets, but could also generate more surface noise and reduce bottom signal continuity during rough sea conditions. Wider beam widths generate larger arches for fish target returns, making them ideal for locating fish. Wider beam widths also perform better in deep water, because the lower frequency has better deep water penetration.

CHIRP frequencies allow you to sweep each pulse through a range of frequencies, resulting in better target separation in deep water. CHIRP can be used to distinctly identify targets, like individual fish in a school, and

for deep water applications. CHIRP generally performs better than single frequency applications. Because some fish targets may show up better using a fixed frequency, you should consider your goals and water conditions when using CHIRP frequencies.

Some transducers also provide the ability to customize preset frequencies for each transducer element, which enables you to change the frequency quickly using the presets as the water and your goals change.

Viewing two frequencies concurrently using the split-frequency view allows you to see deeper with the lower frequency return and, at the same time, see more detail from the higher frequency return.

NOTICE

Always be aware of local regulations on sonar frequencies. For example, to protect orca whale pods, you might be prohibited from using frequencies between 50 to 80 kHz within $\frac{1}{2}$ mile of an orca whale pod. It is your responsibility to use the device in compliance with all applicable laws and ordinances.

Selecting the Transducer Frequency

You cannot adjust the frequency for all sonar views and transducers.

You can select which frequencies appear on the sonar screen.

NOTICE

Always be aware of local regulations on sonar frequencies. For example, to protect orca whale pods, you might be prohibited from using frequencies between 50 to 80 kHz within $\frac{1}{2}$ mile of an orca whale pod. It is your responsibility to use the device in compliance with all applicable laws and ordinances.

- 1 From a sonar view, select **Options > Frequency**.
- 2 Select a frequency suited to your needs and water depth.
For more information on frequencies, see [Sonar Frequencies, page 94](#).

Creating a Frequency Preset

Not available with all transducers.

You can create a preset to save a specific sonar frequency, which allows you to change frequencies quickly.

- 1 From a sonar view, select **Options > Frequency**.
- 2 Select **Manage Frequencies > New Preset**.
- 3 Enter a frequency.

Turning On the A-Scope

NOTE: This feature is available in the Traditional sonar views.

The a-scope is a vertical flasher along the right side of the view, showing you what is underneath the transducer right now. You can use the a-scope to identify target returns that may be missed when the sonar data is quickly scrolling across the screen, such as when your boat is moving at high speeds. It can also be helpful for detecting fish that are close to the bottom.

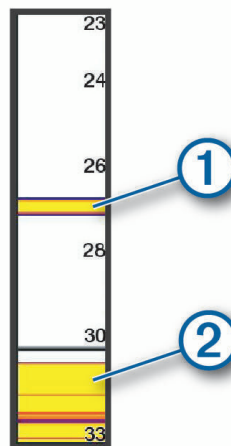

The a-scope above shows fish returns ① and a soft bottom return ②.

- 1 From a sonar view, select **Options > Sonar Setup > Appearance > A-Scope**.
- 2 If necessary, select **⋮ > Peak Hold** to adjust the length of time the sonar returns are displayed.

Heave Compensation

In wavy conditions, the record of the bottom on the sonar screen may raise up and down with the vessel as it is affected by waves. You can activate the heave compensation feature to adjust for the sea condition and provide steady sonar recordings.

To use the heave compensation feature, you must meet specific requirements:

- You must install at least one compatible transducer connected to the chartplotter, or a compatible sonar module on the network with a transducer installed and connected to it.
- You must install at least one MSC™ 10 heading and attitude sensor and connect it to the same NMEA 2000® network as the chartplotter or chartplotters where you want to use the heave compensation feature.
- You must configure the positions of these connected sensors on the vessel.

Configuring Sensors for Heave Compensation

You must mount and connect at least one compatible transducer and at least one MSC™ 10 heading sensor before you can configure them for heave compensation.

Before the heave compensation feature can accurately adjust the sonar readings to account for the affects of waves on the vessel, you must configure the software to identify the location of the sensors on the vessel.



- 1 Select  > **My Vessel** > **Device Position**.
- 2 Select a connected compatible transducer.
- 3 Follow the on-screen instructions to enter values for each axis of the transducer position in relation to the vessel.
- 4 Select a connected MSC 10 heading sensor.
- 5 Follow the on-screen instructions to enter values for each axis of the heading-sensor position in relation to the vessel.
- 6 Repeat the previous steps for additional compatible transducers and heading sensors if applicable.

Using Heave Compensation on a Sonar View

Before you can use the heave compensation feature on a sonar view, you must install and connect a compatible transducer and heading sensor, and configure their locations on the vessel.

When the necessary equipment is installed, the heave compensation feature activates automatically on the applicable sonar views.

- 1 Open a **Traditional** or RealVü sonar view.
- 2 Observe the icon in the lower-left corner of the sonar view.

	The heave compensation feature is working correctly.
	There is a configuration error with one or more of the sensors required for heave compensation. You can select the message banner for more information.
No icon present	The necessary transducer, sensor, or both are not installed or configured correctly. Heave compensation is not applicable to this sonar view. Heave compensation is disabled.

Turning On Heave Compensation

When the appropriate transducer and sensors are installed and configured correctly to activate the heave compensation feature, you can turn on and turn off the feature as needed.



- 1 From a sonar view, select **Options** > **Sonar Setup** > **Installation** > **Transducers**.
- 2 Select the name of the transducer you configured for heave compensation.
- 3 Select **Heave Compensation**.

Panoptix™ Sonar Setup

Adjusting the RealVü Viewing Angle and Zoom Level

You can change the viewing angle of the RealVü sonar views. You can also zoom in and out of the view.

From a RealVü sonar view, select an option:

- To adjust the viewing angle diagonally, select .
- To adjust the viewing angle horizontally, select .
- To adjust the viewing angle vertically, select .
- To adjust the viewing angle, swipe the screen in any direction.

- To zoom in, spread two fingers apart.
- To zoom out, pinch two fingers together.

Adjusting the RealVü Sweep Speed

You can update how quickly the transducer sweeps back and forth. A faster sweep rate creates a less detailed image, but the screen refreshes faster. A slower sweep rate creates a more detailed image, but the screen refreshes more slowly.

This feature is not available for the RealVü 3D Historical sonar view.

- 1 From a RealVü sonar view, select **Options > Sweep Speed**.
- 2 Select an option.

LiveVü Forward and Garmin FrontVü™ Sonar Settings

From the LiveVü Forward or Garmin FrontVü sonar view, select Options.

Gain: Controls the level of detail and noise shown on the sonar screen.

If you want to see the highest intensity signal returns on the screen, you can lower the gain to remove lower intensity returns and noise. If you want to see all return information, you can increase the gain to see more information on the screen. This also increases noise, and can make it more difficult to recognize actual returns.

Depth Range: Adjusts the range of the depth scale.

Allowing the device to adjust the range automatically keeps the bottom within the lower portion of the sonar screen, and can be useful for tracking a bottom that has minimal or moderate terrain changes.

Manually adjusting the range enables you to view a specified range, which can be useful for tracking a bottom that has large terrain changes, such as a drop-offs or cliffs. The bottom can appear on the screen as long as it appears within the range you have set.

Forward Range: Adjusts the range of the forward scale.

Allowing the device to adjust the range automatically adjusts the forward scale in relation to the depth.

Manually adjusting the range enables you to view a specified range. The bottom can appear on the screen as long as it appears within the range you have set. Manually reducing this option can reduce the effectiveness of the FrontVü Alarm, reducing your reaction time to low depth readings.

Transmit Angle: Adjusts the focus of the transducer to the port or starboard side. This feature is available only with RealVü capable Panoptix transducers, such as the PS31 transducer.

Transmit: Stops the active transducer from transmitting.

FrontVü Alarm: Sets an alarm to sound when the depth in front of the vessel is less than the specified value ([Setting the Garmin FrontVü™ Depth Alarm, page 97](#)). This is available only with Panoptix Garmin FrontVü transducers.

Sonar Setup: Adjusts the setup of the transducer and the appearance of the sonar returns.

Edit Overlays: Adjusts the data shown on the screen ([Customizing the Data Overlays, page 25](#)).

Setting the LiveVü and Garmin FrontVü™ Transducer Transmit Angle

This feature is available only with RealVü capable Panoptix transducers, such as the PS30, PS31, and PS60.

You can change the transducer transmit angle to aim the transducer at a particular area of interest. For example, you might aim the transducer to follow a bait ball or focus on a tree as you pass it.

- 1 From a LiveVü or Garmin FrontVü sonar view, select **Options > Transmit Angle**.
- 2 Select an option.

Setting the Garmin FrontVü™ Depth Alarm

WARNING

Garmin FrontVü sonar and the Garmin FrontVü depth alarm are tools for situational awareness only, and may not prevent groundings in all circumstances. As vessel speeds approach and exceed 8 knots, your ability to effectively respond to the information provided by the sonar and/or alarm decreases. It is your responsibility to remain aware of your surroundings while underway and to operate your vessel in a safe and prudent manner. Failure to do so could result in an accident leading to property damage, personal injury, or death.

CAUTION

The Beeper setting must be turned on to make alarms audible ([Sounds and Display Settings, page 200](#)). Failure to set audible alarms could lead to injury or property damage.

NOTE: This alarm is available only with Panoptix™ Garmin FrontVü transducers.

You can set an alarm to sound when the depth is below a specified level. For best results, you should set the bow offset when using the front collision alarm ([Setting the Bow Offset, page 99](#)).

- 1 From the Garmin FrontVü sonar view, select **Options > FrontVü Alarm**.
- 2 Select **On**.
- 3 Enter the depth at which the alarm is triggered, and select **Done**.

On the Garmin FrontVü screen, a depth line shows the depth at which the alarm is set. The line is green when you are in a safe depth. The line turns yellow when you are going faster than the forward range gives you time to react (10 seconds). It turns red and sounds an alarm when the system detects an obstruction or the depth is less than the entered value.

LiveVü and Garmin FrontVü™ Appearance Settings

From a LiveVü or Garmin FrontVü Panoptix sonar view, select **Options > Sonar Setup > Appearance**.

Color Scheme: Sets the color palette.

Color Gain: Adjusts the intensity of colors shown on the screen.

You can select a higher color gain value to see targets higher in the water column. A higher color gain value also allow you to differentiate low intensity returns higher in the water column, but this causes a loss in the differentiation of the returns at the bottom. You can select a lower color gain value when targets are near the bottom, to help you distinguish between targets and high intensity returns such as sand, rock, and mud.

Trails: Sets the how long the trails appear on the screen. The trails show the movement of the target.

Bottom Fill: Colors the bottom brown to distinguish it from the water returns.

LiveVü and Garmin FrontVü™ Layout Settings

From a LiveVü or Garmin FrontVü Panoptix sonar view, select **Options > Sonar Setup > Layout**.

Grid Overlay: Shows a grid of range lines.

Scroll History: Shows the sonar history on the side of the screen.

Beam Icon: Selects the icon used to show the direction of the transducer beam.

On-screen Control: Shows the on-screen buttons.

Compress Range: In forward views, compresses the forward range farther away from the boat and expands the range closer to the boat. This allows you to see closer objects more clearly while keeping farther objects on the screen.

RealVü Appearance Settings

From a RealVü sonar view, select **Options > Sonar Setup > Appearance**.

Point Colors: Sets a different color palette for the sonar return points.

Bottom Colors: Sets the color scheme for the bottom.

Bottom Style: Sets the style for the bottom. When you are in deep water, you can select the Points option and manually set the range to a shallower value.

Color Key: Shows a legend of the depths the colors represent.

On-screen Control: Shows or hides the on-screen buttons.

Panoptix™ Transducer Installation Settings

From a Panoptix sonar view, select **Options > Sonar Setup > Installation**.

Install Depth: Sets the depth below the water line where the Panoptix transducer is mounted. Entering the actual depth at which the transducer is mounted results in a more accurate visual presentation of what is in the water.

Bow Offset: Sets the distance between the bow and the forward view Panoptix transducer installation location. This allows you to view the forward distance from the bow instead of the transducer location.

This applies to Panoptix transducers in the Garmin FrontVü™, LiveVü Forward, and RealVü 3D Forward sonar views.

Beam Width: Sets the width of the down view Panoptix transducer beam. Narrow beam widths allow you to see deeper and farther. Wider beam widths allow you to see more coverage area.

This applies to Panoptix transducers in the Garmin FrontVü, LiveVü Down, and LiveVü Forward sonar views.

Stabilization > Auto Stabilize: Enables the internal attitude heading sensors to detect the installation angle of the Panoptix transducer automatically. When this setting is turned on, you cannot manually specify the installation angle for the transducer.

Stabilization > Pitch Angle: Available only when Auto Stabilize is turned off. Allows you to enter the specific installation angle for the transducer. Many forward view transducers are installed at a 45-degree angle and down view transducers are installed at a zero-degree angle.

Stabilization > Flipped: Sets the orientation of the Panoptix sonar view when the down view transducer is installed with the cables pointing toward the port side of the boat.

This applies to Panoptix transducers in the LiveVü Down, RealVü 3D Down, and RealVü 3D Historical sonar views.

Calibrate Compass: Calibrates the internal compass in the Panoptix transducer ([Calibrating the Compass, page 99](#)).

This applies to Panoptix transducers with an internal compass, such as the PS21-TR transducer.

Orientation: Controls if the transducer is in down or forward installation mode. The Auto setting uses the AHRS sensor to determine the orientation.

This applies to PS22 transducers.

Restore Sonar Defaults: Restores the sonar settings to the factory default values.

Setting the Bow Offset

For forward view Panoptix™ transducers, you can enter a bow offset to compensate the forward distance readings for the transducer installation location. This allows you to view the forward distance from the bow instead of the transducer installation location.

This feature applies to Panoptix transducers in the Garmin FrontVü™, LiveVü Forward, and RealVü 3D Forward sonar views.

- 1 Measure the horizontal distance ① from the transducer to the bow.

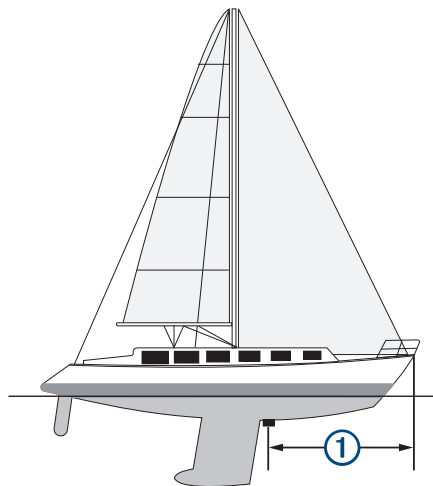

- 2 From an applicable sonar view, select **Options > Sonar Setup > Installation > Bow Offset**.

- 3 Enter the distance measured, and select **Done**.

On the applicable sonar view, the forward range shifts by the distance you entered.

Calibrating the Compass

Before you can calibrate the compass, the transducer must be installed far enough away from the trolling motor to avoid magnetic interference, and deployed in the water. Calibration must be of sufficient quality to enable the internal compass.

NOTE: The compass may not work if you mount the transducer on the motor.

NOTE: For best results, you should use a heading sensor such as the SteadyCast™ heading sensor. The heading sensor shows the direction the transducer is pointing relative to the boat.

NOTE: Compass calibration is available only for transducers with an internal compass, such as the PS21-TR transducer.

You can begin turning your boat before calibrating, but you must fully rotate your boat 1.5 times during calibration.

- 1 From an applicable sonar view, select **Options > Sonar Setup > Installation**.
- 2 If necessary, select **Use AHRS** to turn on the AHRS sensor.
- 3 Select **Calibrate Compass**.

4 Follow the on-screen instructions.

LiveScope and Perspective Sonar Settings

From the LiveScope or Perspective sonar view, select Options.

Gain: Controls the level of detail and noise shown on the sonar screen.

If you want to see the highest intensity signal returns on the screen, you can lower the gain to remove lower intensity returns and noise. If you want to see all return information, you can increase the gain to see more information on the screen. Increasing the gain also increases noise, and can make it more difficult to recognize actual returns.

Depth Range: Adjusts the range of the depth scale.

Allowing the device to adjust the range automatically keeps the bottom within the lower portion of the sonar screen, and can be useful for tracking a bottom that has minimal or moderate terrain changes.

Manually adjusting the range enables you to view a specified range, which can be useful for tracking a bottom that has large terrain changes, such as a drop-offs or cliffs. The bottom can appear on the screen as long as it appears within the range you have set.

Available in LiveScope sonar view.

Forward Range: Adjusts the range of the forward scale.

Allowing the device to adjust the range automatically adjusts the forward scale in relation to the depth.

Manually adjusting the range enables you to view a specified range. The bottom can appear on the screen as long as it appears within the range you have set.

Available in LiveScope sonar view.

Range: Adjusts the range.

Allowing the device to adjust the range automatically keeps the bottom within the lower or outer third of the sonar screen, and can be useful for tracking a bottom that has minimal or moderate terrain changes.

Manually adjusting the range enables you to view a specified range, which can be useful for tracking a bottom that has large terrain changes, such as a drop-offs or cliffs. The bottom can appear on the screen as long as it appears within the range you have set.

Available in Perspective sonar view.

Transmit: Stops the active transducer from transmitting.

Sonar Setup: Adjusts the setup of the transducer and the appearance of the sonar returns (*LiveScope and Perspective Sonar Setup, page 100*).

Edit Overlays: Adjusts the data shown on the screen (*Customizing the Data Overlays, page 25*).

LiveScope and Perspective Sonar Setup

From the LiveScope or Perspective sonar view, select **Options** > **Sonar Setup**.

Appearance: Configures the appearance of the sonar screen (*LiveScope and Perspective Appearance Settings, page 100*).

Layout: Configures the layout of the sonar screen (*LiveScope and Perspective Layout Settings, page 101*).

Noise Reject: Reduces noise and interference and attempts to remove returns that are not actually targets in the water.

Ghost Reject: Reduces the occurrence of "ghost" images, which are duplicated or reflected images that are not actually targets in the water. The Ghost Reject setting sends more transmit power forward in the water to see farther with less noise generated by the bottom. Adjusting the Ghost Reject and Noise Reject settings together reduces the occurrence of "ghost" images most effectively. This feature is available in LiveScope Forward orientation only.

TVG: Adjusts the time varying gain, which can reduce noise.

This control is best used for situations when you want to control and suppress clutter or noise near the water surface. It also allows for the display of targets near the surface that are otherwise hidden or masked by surface noise.

Overlay Data: Sets the data shown on the sonar screen.

Installation: Configures the transducer (*LiveScope and Perspective Transducer Installation Settings, page 101*).

LiveScope and Perspective Appearance Settings

From the LiveScope or Perspective sonar view, select **Options** > **Sonar Setup** > **Appearance**.

Color Scheme: Sets the color palette.

Color Gain: Adjusts the contrast of colors shown on the screen.

You can select a higher color gain value to see minor variances in targets with large color changes. You can select a lower color gain value to see more similar colors in the same situation.

Trails: Sets the how long the trails appear on the screen. The trails show the movement of the target.

Bottom Fill: Colors the bottom brown to distinguish it from the water returns. Not available in Perspective mode.

LiveScope and Perspective Layout Settings

From the LiveScope or Perspective sonar view, select **Options > Sonar Setup > Layout**.

Grid Overlay: Shows a grid of range lines. The Grid option shows a square grid. The Radial option shows a circular grid with radial angle lines.

Scroll History: Shows the sonar history on the side of the screen. Not available in Perspective mode.

Beam Icon: Selects the icon used to show the direction of the transducer beam.

Beam Overlay: Enables an outline to show where the transducers are oriented in relation to each other, when two or more calibrated Panoptix™ transducers are connected.

On-screen Control: Shows the on-screen buttons.

Reverse Range: Adjusts the amount of range shown behind the transducer.

Compress Range: In forward views, compresses the forward range farther away from the boat and expands the range closer to the boat. This allows you to see closer objects more clearly while keeping farther objects on the screen.

LiveScope and Perspective Transducer Installation Settings

From the LiveScope or Perspective sonar view, select **Options > Sonar Setup > Installation**.

Install Depth: Sets the depth below the water line where the Panoptix™ transducer is mounted. Entering the actual depth at which the transducer is mounted results in a more accurate visual presentation of what is in the water.

Stabilization > Auto Stabilize: Enables the internal attitude heading sensors to detect the installation angle of the Panoptix transducer automatically. When this setting is turned on, you cannot manually specify the installation angle for the transducer.

Stabilization > Pitch Angle: Available only when Auto Stabilize is turned off. Allows you to enter the specific installation angle for the transducer. Many forward view transducers are installed at a 45-degree angle and down view transducers are installed at a zero-degree angle.

Stabilization > Flipped: Sets the orientation of the Panoptix sonar view when the down view transducer is installed with the cables pointing toward the port side of the boat.

This applies to Panoptix transducers in the LiveVü Down, RealVü 3D Down, and RealVü 3D Historical sonar views.

Calibrate Compass: Calibrates the internal compass in the Panoptix transducer ([Calibrating the Compass, page 99](#)).

This applies to LiveScope™ transducers with an internal compass.

Orientation: Controls if the transducer is in down or forward installation mode. The Auto setting uses the AHRS sensor to determine the orientation.

Focus: Adjusts the sonar view to compensate for the speed of sound in water. The Auto setting uses the temperature of the water to calculate the speed of sound.

Heading Source: Allows the system to reference the heading source from either the transducer or a compatible Garmin® trolling motor. This may help avoid interference from the trolling motor when the transducer is installed on the barrel. This setting appears only when a compatible Garmin trolling motor is detected.

Heading Offset: Adjusts the referenced heading to match the actual heading, if needed. This setting appears only when a compatible Garmin trolling motor is set as the heading source.

Restore Sonar Defaults: Restores the sonar settings to the factory default values.

Spy Pole Control

Connecting a Garmin® Spy pole to the chartplotter allows you to configure and control the Spy pole from a chartplotter screen. Some features of the Spy pole are available only after connecting it to a chartplotter along with required supplementary devices and configuring it properly.

NOTICE

You must install the Spy pole on your vessel according to the instructions provided with the Spy pole. Incorrectly installing the Spy pole may result in damage to the device or your vessel, or may result in poor performance.

Connecting a Spy Pole to a Garmin® Chartplotter

A Spy pole can connect to one compatible Garmin chartplotter at a time. After connecting a Spy pole to a chartplotter, you can control it using any other chartplotter connected to the same Garmin BlueNet™ or Garmin Marine Network.

Up to four Spy poles can connect to a Garmin BlueNet or Garmin Marine Network at the same time.

- 1 Turn on the Spy pole.
- 2 Press  on the Spy pole three times.
The LED turns solid blue, indicating that the device is ready to connect.
- 3 On the chartplotter, select **Home > Settings > Communications > Wireless Devices > Spy™ Pole Mount > Start**.
- 4 Wait for the chartplotter to connect to the Spy pole.
The LED on the Spy pole turns green again after the devices are connected successfully.

After you connect a Spy pole to a chartplotter successfully, you are prompted to complete the setup wizard on the chartplotter screen. It is highly recommended to complete the wizard at this time for the best results.

Adding the Spy Pole Controls to Screens

After you have connected a Spy pole to the chartplotter, you must add the Spy™ Pole control bar to screens to control and configure the Spy pole.

- 1 Open a screen from which you want to control the Spy pole.
- 2 Select an option:
 - From a full screen, select **Options > Edit Overlays**.
 - From a combination screen, select **Options > Edit > Overlays**.
- 3 Select **Top Bar, Bottom Bar, Left Bar, or Right Bar**.
- 4 Select **Spy™ Pole**.



Repeat these steps to add the Spy pole controls to all of the screens from which you want to control the Spy pole.



Spy Pole Control Bar

The Spy pole control bar allows you to control Spy poles connected to the chartplotter.

You can select an item to engage or disengage it. The button illuminates when it is engaged.





①	The name of the connected Spy pole associated with the control bar. If you have more than one Spy pole connected to the Garmin BlueNet™ or Garmin® Marine Network, select this to choose a different device to control.
②	Status of the Spy pole.
	Select to engage SpyLink™ synchronization. You can use this feature only when the Spy pole is connected to a compatible Garmin trolling motor (SpyLink™ Synchronization, page 103).
	Select to engage automatic SpyLock™ point locking (SpyLock™ Feature, page 103).
	Select to engage SpyScan™ search mode (SpyScan™ Search Mode, page 104).

	Select to engage OneVü™ sonar 360-degree scanning. You can use this feature only after you connect a compatible 360-degree sonar transducer, such as a Garmin GT360UHD, to the end of the Spy pole, and assign it to that Spy pole (<i>OneVü™ Scanning Sonar</i> , page 86).
	Select to turn the Spy pole to the left or right in step increments.
	Select to open options and settings for the Spy pole (<i>Spy Pole Options and Settings</i> , page 104).

Pairing with a Force® Trolling Motor

You can pair a Spy pole with a compatible Force trolling motor to enable additional functionality. A Force trolling motor can be paired to only one Spy pole at a time.

- 1 Turn on the Spy pole.
- 2 Press  on the Spy pole three times.
The LED turns solid blue, indicating that the device is pairing.
- 3 On the trolling motor, press  three times.
The pairing LED on the trolling motor turns blue, indicating that the device is pairing.
- 4 Wait for the trolling motor to pair with the Spy pole.
The LEDs on the Spy pole and trolling motor turn green again after the devices are paired successfully.

SpyLink™ Synchronization

SpyLink synchronization allows you to synchronize the movement of a Spy pole with a paired Force® trolling motor. When SpyLink synchronization is engaged, the sonar view from a transducer connected to the Spy pole turns in the same direction that you steer the trolling motor. When SpyLink synchronization is engaged, and the trolling motor is set to Anchor Lock, using the Force foot pedal turns the Spy pole instead of the trolling motor. You can start and stop SpyLink synchronization from the Spy pole control bar (*Adding the Spy Pole Controls to Screens*, page 102), or you can program a button on the gesture remote or Spy foot control to start and stop synchronization.

SpyLink™ Feature Requirements

Before you can use the SpyLink feature with the Spy pole, you must perform specific configuration processes on the system.

- You must install a compatible Force® trolling motor on the vessel and pair it with the Spy pole (*Pairing with a Force® Trolling Motor*, page 103).
- You must update the Force trolling motor to the latest released software. See the owner's manual for your trolling motor for software-update instructions.
- You must set the bow offset for the Spy pole and for the trolling motor.
TIP: For the best results, you should set the bow offset for both the Spy pole and the Force trolling motor at the same time. This helps to ensure that the two devices are in alignment with one another.

SpyLock™ Feature

The SpyLock feature allows you to use the Spy pole to turn your transducer view automatically to keep a particular point or area in view on the sonar screen. You can set a SpyLock point manually, or you can use the automatic SpyLock option to have the system automatically lock onto a specific sonar range. You can configure the range at which the system automatically locks onto a view (*Spy Pole Options and Settings*, page 104).

SpyLock™ Feature Requirements

Before you can use the SpyLock feature, you must install and configure specific devices on the system.

NOTE: Many of these configuration and calibration items are performed during the wizard that appears when you first connect a Spy pole to the chartplotter. If needed you can set or adjust any of them from the device settings (*Spy Pole Options and Settings*, page 104).

- GPS data must be provided to the chartplotter from a GPS antenna or device on the NMEA 2000® network, Garmin BlueNet™ network, or Garmin® Marine Network.
- You must install and connect a heading sensor to provide heading data. This data can be provided by the Spy heading sensor included with the Spy pole or you can use a heading sensor connected to the same NMEA 2000 network, Garmin BlueNet network, or Garmin Marine Network as the chartplotter.
- You must calibrate the heading sensor, especially if it is the Spy heading sensor included with the Spy pole (*Calibrating the Spy Heading Sensor Paired with a Spy Pole*, page 105).
- You must set the bow offset for the Spy pole (*Setting the Spy Pole Bow Offset*, page 105).

- You must set device-position information for the Spy pole and all of the relevant sensors on the network ([Setting the Position of the Devices on the Boat, page 106](#)).
- You must connect a compatible LiveScope™ transducer to the Spy pole.
- You must assign the LiveScope transducer to the Spy pole. ([Spy Pole Options and Settings, page 104](#))
- You must connect the LiveScope transducer to a chartplotter or sonar module on the network.

Setting a SpyLock™ Point on a Chart or Sonar View

You can identify a point on a traditional, Garmin ClearVü™, LiveScope™, or OneVü™ sonar view and use the SpyLock point-locking feature to keep that point centered as you drive the boat. The Spy pole turns automatically as needed.

NOTE: You can engage automatic SpyLock point locking from the Spy pole control bar if you want the system to automatically lock to a user-defined percentage of the LiveScope range ([Adding the Spy Pole Controls to Screens, page 102](#)).

- 1 From a chart or sonar view where you want to use SpyLock point locking, touch a point on the chart or sonar view where you want to engage the lock.

If applicable, the sonar view pauses.

- 2 Select  to engage SpyLock locking on the selected point.

You can disengage the SpyLock lock by engaging a different feature on the Spy pole or by manually steering the Spy pole. Additionally, you can disengage the SpyLock lock by selecting  on a traditional or Garmin ClearVü sonar view.

SpyScan™ Search Mode

With the SpyScan search mode, the Spy pole continuously pans from one side to the other to provide a wider area sonar view when using a LiveScope™ transducer.

You can start and stop SpyScan search mode from the Spy pole control bar ([Adding the Spy Pole Controls to Screens, page 102](#)).

You can configure the behavior of the SpyScan search mode, such as the angle, direction, and speed of the scan ([Spy Pole Options and Settings, page 104](#)).

Spy Pole Options and Settings

You can configure the options and settings for a connected Spy pole, such as setting actions for the gesture remote or foot control and calibrating the heading sensor.

To open the Spy pole settings, you must first add the Spy™ Pole control bar to a screen. To view the settings, from the Spy™ Pole control bar, select .

NOTE: When the chartplotter first detects a new Spy pole connection, you are prompted to begin a setup wizard that allows you to set these configuration options and calibrate the heading sensor. You can use the settings in this menu at any time to update the Spy pole configuration or calibrate the heading sensor again.

SpyScan™: Starts and stops SpyScan™ search mode. Select  to configure various SpyScan settings such as the angle, direction, and speed ([SpyScan™ Search Mode, page 104](#)).

SpyLink™: Starts and stops SpyLink™ synchronization with a connected Garmin® trolling motor ([SpyLink™ Synchronization, page 103](#)).

Auto SpyLock™: Starts and stops the automatic SpyLock™ point locking. Select  to adjust the range of this feature ([SpyLock™ Feature, page 103](#)).

Gesture Remote: Sets the actions associated with the buttons on a connected gesture remote.

Spy™ Foot Control: Sets the actions associated with the buttons on a connected Spy foot control.

Set Pole Name: Sets the name for this Spy pole. This is helpful when you have more than one Spy pole connected to the same Garmin BlueNet™ or Garmin Marine Network.

Installation > Transducer Auto Park: Sets the side to turn and park the Spy pole when it is stowed.

Installation > Setup Wizard: Re-runs the Spy pole setup wizard.

Installation > Calibrate: Sets individual calibration values independent of the setup wizard ([Configuring a Spy Pole, page 105](#)).

Installation > Connected Transducers: Sets the transducer or transducers installed on the Spy pole. If you have more than one transducer installed on the Spy pole, you can set the primary transducer used for functions such as the automatic SpyLock feature.

Installation > Auto Power On: Sets the power-on behavior for the Spy pole. By default, the Spy pole turns on automatically when it receives power. You can change this so that you must manually press  to turn it on.

Installation > Restore Defaults: Restores the Spy pole default settings, but does not remove calibration data or pairing data.

Installation > Factory Defaults: Restores the Spy pole factory-default settings, including calibration data. Also removes any pairing data with a chartplotter and other peripheral devices.

Configuring a Spy Pole

After installing a Spy pole and connecting it to the chartplotter, you are prompted to start a setup wizard to perform the initial configuration and calibration. You can adjust each configuration value or perform calibration if you skipped the setup wizard or want to refine any of the specific settings.

- 1 From the **Spy™ Pole** control bar, select  > **Installation > Calibrate**.
- 2 Select an option:
 - To set the bow offset, select **Bow Offset**.
 - To calibrate a connected Spy heading sensor, select **Spy™ Heading Sensor** (*Calibrating the Spy Heading Sensor Paired with a Spy Pole, page 105*).
 - To calibrate the steering alignment, select **Steering Alignment**.
- 3 Follow the on-screen instructions to complete the configuration or calibration.
- 4 Repeat this procedure for any other settings you want to configure or calibrate.

Calibrating the Spy Heading Sensor Paired with a Spy Pole

You are prompted to calibrate the Spy heading sensor after installation. You can perform this process from the chartplotter if you skipped the initial calibration or want to calibrate it again to provide better results.

NOTE: A Spy heading sensor is required only if there is no other source of heading information available to the chartplotter over the NMEA 2000® network, Garmin BlueNet™ network, or Garmin® Marine Network.

- 1 If necessary, add the **Spy™ Pole** control bar to a screen (*Adding the Spy Pole Controls to Screens, page 102*).

- 2 From the **Spy™ Pole** control bar, select  > **Installation > Calibrate > Spy™ Heading Sensor**.

The calibration wizard opens.

- 3 Select **Begin** and follow the on-screen instructions until the compass calibration is complete, taking care to keep the boat as steady and level as possible.

The boat should not list during calibration.

If possible, you can turn the vessel in place by engaging two engines in opposite directions.

NOTE: If the heading performance is unacceptable after calibration, you may need to relocate the sensor and calibrate the compass again. Refer to the Spy pole installation instructions for further details.

- 4 Select **Auto Heading Alignment**.

NOTE: This alignment method is available only if there is a GPS source present on the Garmin BlueNet network or Garmin Marine Network. If a GPS source is not connected, you must align the heading manually (*Adjusting the Fine Heading Alignment, page 105*).

- 5 Select **Begin**.

- 6 Follow the on-screen instructions until the alignment is complete.

Adjusting the Fine Heading Alignment

If you do not have a GPS source present on the Garmin BlueNet™ network or Garmin® Marine Network, the Auto Heading Alignment option is not available as part of menu-based calibration. You must adjust the Fine Heading Alignment instead.

You can adjust the Fine Heading Alignment in conjunction with Auto Heading Alignment to fine-tune the heading output (optional).

- 1 Start the Spy heading sensor calibration, and skip directly to **Fine Heading Alignment**.
- 2 Using a landmark or a known good compass, determine the heading of your boat.
- 3 Adjust the heading until it matches your measurement.
- 4 Select **Done**.

Setting the Spy Pole Bow Offset

Based on the installation angle, the Spy pole may not align with the center line of your boat. For the best results, you should set the bow offset.

- 1 Adjust the angle of the Spy pole ① so it aligns with the center line of your boat ②, pointing straight forward.

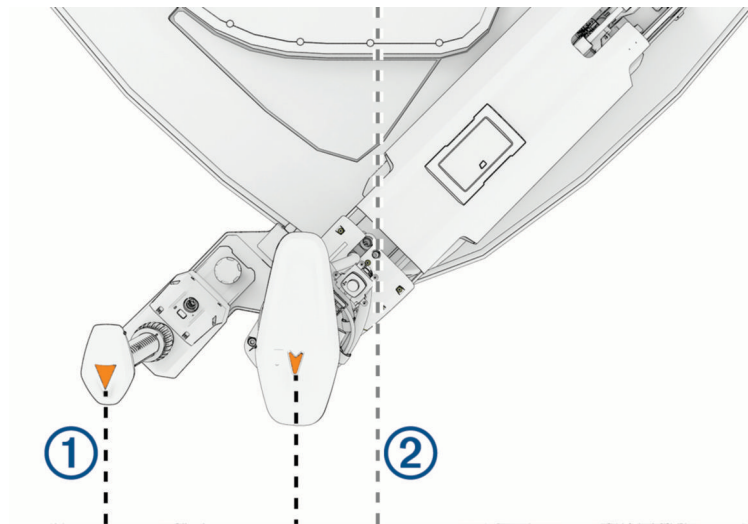

2 From the Spy pole control bar, select  > **Installation** > **Calibrate** > **Bow Offset**.

Calibrating the Spy Pole Steering Alignment

The Spy pole shaft is aligned at the factory, and should not need regular alignment. Occasionally, due to an impact or an unexpected manual shaft rotation, the Spy pole steering may appear off, or you may receive an error message regarding the steering alignment. You can perform this alignment procedure to correct this type of error.

- 1 If necessary, deploy the Spy pole.
- 2 From the Spy pole control bar, select  > **Installation** > **Calibrate** > **Steering Alignment**.
- 3 Follow the on-screen instructions and select **Begin**.
NOTE: The Spy pole performs a number of steering motions during the calibration process.
- 4 Wait until the calibration process is complete.

Setting the Position of the Devices on the Boat

Some advanced features of the Spy pole, such as the SpyLock™ feature and OneVü™ scans require you to define the position of devices and sensors on the boat. When you first connect a Spy pole to the chartplotter, you are prompted to begin a setup wizard, which includes the device-position configuration. You can run this again at any time to set or refine these values for the best performance.

- 1 If you are not running this configuration as part of the Spy pole setup wizard, select  > **My Vessel** > **Device Position**.
- 2 Select sensor name in the window on the left, then press **Select**.
- 3 Select **Starboard/Port Offset**.
- 4 Using the on-screen image as a guide, measure the distance from the center line of the boat to the installed location of the Spy pole.
- 5 Select **Starboard/Port Offset** and enter the value you measured in the previous step.
- 6 Select **Stern Offset**.
- 7 Using the on-screen image as a guide, measure the distance from the stern (rear) of the boat to the installed location of the Spy pole.
- 8 Select **Stern Offset** and enter the value you measured in the previous step.
- 9 After you have measured and entered the values for both of these, select **Back**.
- 10 Repeat this procedure for the other devices shown in the **Device Position** window.

Pairing Spy Pole Accessories

A Spy pole is paired with a Spy gesture remote, a Spy foot control, and a Spy heading sensor at the factory. If you replace one of these accessories or add additional control accessories, you must pair them to the Spy pole. You can pair up to five Spy gesture remotes with one Spy pole at a time. You can pair only one Spy foot control and one Spy heading sensor to one Spy pole at a time.

If you have multiple Spy poles installed on the boat, one Spy heading sensor can connect to up to four Spy poles.

- 1 Turn on the Spy pole.
- 2 Press  on the Spy pole three times.
The LED turns solid blue, indicating that the device is pairing.
- 3 Select an option depending on the type of accessory you are pairing to the Spy pole:
 - To pair a Spy gesture remote, press the left and right buttons on the remote simultaneously three times.
 - To pair a Spy foot control, press the top two programmable buttons on the foot control simultaneously three times.
 - To pair a Spy heading sensor, press the button on the heading sensor three times.The LED on the gesture remote or foot control flashes blue, or the LED on the heading sensor turns solid blue, indicating that the device is pairing.
- 4 Wait for the accessory to connect to the Spy pole.
The LED on the Spy pole turns green, and the LED on the accessory flashes green after the devices are paired successfully.
- 5 Repeat this procedure for any additional accessories you want to pair with the Spy pole.

Radar

⚠ WARNING

The marine radar transmits microwave energy that has the potential to be harmful to humans and animals. Before beginning radar transmission, verify that the area around the radar is clear. The radar transmits a beam approximately 12° above and below a line extending horizontally from the center of the radar.

To avoid possible personal injury, do not look directly at the antenna at close range when the radar is transmitting. Eyes are the most sensitive part of the body to electromagnetic energy.

When you connect your compatible chartplotter to an optional Garmin® marine radar, such as a GMR™ GMR Fantom™ 6 radar or a GMR 24 xHD, you can view more information about your surroundings.

The radar transmits a narrow beam of microwave energy as it rotates to a 360° pattern. When the transmitted energy contacts a target, some of that energy is reflected back to the radar.

Radar Interpretation

Reading and interpreting the radar display takes practice. The more you use the radar, the better you will become at relying on the radar display when you really need it.

Radar can be useful in many situations, such as avoiding collisions when you have limited visibility, for example when it is dark or foggy, tracking weather, seeing what is ahead of you, and locating birds and fish.

The radar overlay feature can help you interpret the radar display more easily, because it overlays the radar returns on top of the chart. This can help you identify the difference between a radar return of a land mass, bridge, or rain cloud. Showing the AIS vessels on the radar overlay can also help you identify features on the radar display.

In the screenshot below, the radar overlay is turned on. This screen also shows a video feed. We can easily identify a few items on the radar screen.

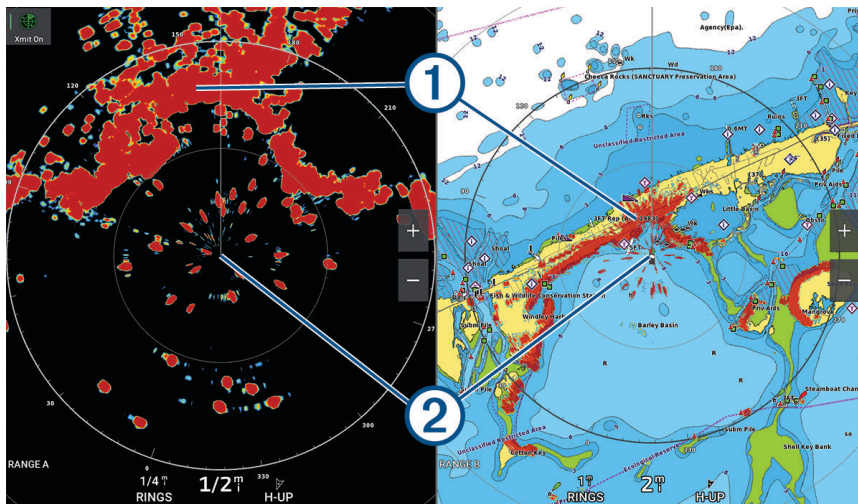

①	Land
②	Vessel

Radar Overlay

When you connect your chartplotter to an optional Garmin® marine radar, you can use overlay radar information on the Navigation chart or on the Fishing chart.

Data appears on the radar overlay based on the most recently used radar mode and all settings configurations applied to the radar overlay are also applied to the last-used radar mode.

Radar Overlay and Chart Data Alignment

When using the Radar overlay, the chartplotter aligns radar data with chart data based on the boat heading, which is based by default on data from a magnetic heading sensor connected using a NMEA® 0183 or NMEA 2000® network. If a heading sensor is not available, the boat heading is based on GPS tracking data.

GPS tracking data indicates the direction in which the boat is moving, not the direction in which the boat is pointing. If the boat is drifting backward or sideways due to a current or wind, the Radar overlay may

not perfectly align with the chart data. This situation should be avoided by using boat-heading data from an electronic compass.

If the boat heading is based on data from a magnetic heading sensor or an automatic pilot, the heading data could be compromised due to incorrect setup, mechanical malfunction, magnetic interference, or other factors. If the heading data is compromised, the Radar overlay may not align perfectly with the chart data.

Transmitting Radar Signals

NOTE: As a safety feature, the radar enters standby mode after it warms up. This gives you an opportunity to verify the area around the radar is clear before beginning radar transmission.

- 1 With the chartplotter off, connect your radar as described in the radar installation instructions.
- 2 Turn on the chartplotter.
If necessary, the radar warms up and a countdown alerts you when the radar is ready.
- 3 Select **Radar**.
- 4 Select a radar mode.
A countdown message appears while the radar is starting up.
- 5 Select **Options > Transmit Radar**.

Stopping the Transmission of Radar Signals

From a radar screen, select **Options > Radar To Standby**.

TIP: Press  > **Radar To Standby** from any screen to quickly stop radar transmission.

Setting Up the Timed Transmit Mode

To help conserve power, you can set up time intervals in which the radar will transmit and not transmit (standby) signal transmissions.

NOTE: This feature is not available in dual radar modes.

- 1 From a radar screen, select **Options > Radar Options > Timed Transmit**.
- 2 Select **Timed Transmit** to enable the option.
- 3 Select **Standby Time**, enter the time interval between radar signal transmissions, and select **Done**.
- 4 Select **Transmit Time**, enter the duration of each radar signal transmission, and select **Done**.

Enabling and Adjusting a Radar No Transmit Zone



You can indicate areas within which the radar scanner does not transmit signals.

GMR™ GMR Phantom™ and xHD2 radar models support two no-transmit zones. Most other GMR radar models support one no-transmit zone. GMR 18 HD+ radar models do not support no-transmit zones.

- 1 From a radar screen, select **Options > Radar Setup > Installation > No Transmit Zone**.
The no-transmit zone is indicated by a shaded area on the radar screen.
- 2 Select **Angle 1**, and select the new location for the first angle.
- 3 Select **Angle 2**, and select the new location for the second angle.
- 4 Select **Done**.
- 5 If necessary, repeat for the second zone.

Adjusting the Radar Range

The range of the radar signal indicates the length of the pulsed signal transmitted and received by the radar. As the range increases, the radar transmits longer pulses in order to reach distant targets. Closer targets, especially rain and waves, also reflect the longer pulses, which can add noise to the Radar screen. Viewing information about longer-range targets can also decrease the amount of space available on the Radar screen for viewing information about shorter-range targets.

- Select  to decrease the range.
- Select  to increase the range.

Tips for Selecting a Radar Range

- Determine what information you need to see on the Radar screen.
For example, do you need information about nearby weather conditions or targets and traffic, or are you more concerned about distant weather conditions?
- Assess the environmental conditions where the radar is being used.

Especially in inclement weather, longer-range radar signals can increase the clutter on the Radar screen and make it more difficult to view information about shorter-range targets. In rain, shorter-range radar signals can enable you to view information about nearby objects more effectively, if the rain clutter setting is configured optimally.

- Select the shortest effective range, given your reason for using radar and the present environmental conditions.

MotionScope™ Doppler Radar Technology

The GMR™ GMR Fantom™ radar uses the Doppler effect to detect and highlight moving targets to help you avoid potential collisions, find flocks of birds, and track weather formations. The Doppler effect is the frequency shift in the radar echo due to the relative motion of the target. This allows for instant detection of any targets moving toward or away from the radar.

The MotionScope feature highlights the moving targets on the radar display so you can navigate around other boats or severe weather, or toward fishing spots where birds are feeding at the surface.

The moving targets are color-coded so you can tell at a glance which targets are moving toward or away from you. On most color schemes, green indicates the target is moving away from you and red indicates the target is moving toward you.

On some models, you can also adjust the M-Scope Sensitivity setting to change the speed threshold for target highlighting. A higher setting highlights slower targets, and a lower setting highlights only faster targets.

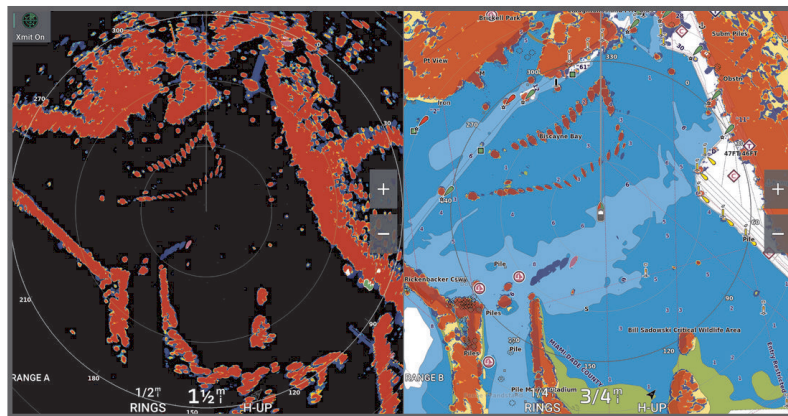

Enabling Guard Zones

You can enable one or two guard zones to alert you when anything comes within specified areas around your boat.

⚠ WARNING

This feature is intended to enhance situational awareness and may not prevent collisions in all circumstances. You are responsible for the safe and prudent operation of your vessel and for remaining aware of obstacles or hazards in or around the water. Failure to do so could result in an accident causing property damage, serious personal injury, or death.

- 1 From a radar screen, select **Options > Radar Options > Guard Zones**.
- 2 Select **Guard Zone 1** or **Guard Zone 2**.

Defining a Circular Guard Zone

Before you can define the boundaries of the guard zone, you must enable a guard zone ([Enabling Guard Zones, page 110](#)).

You can define a circular guard zone that completely surrounds your boat.

- 1 From a radar screen, select **Options > Radar Options > Guard Zones**.
- 2 Select **Guard Zone 1** or **Guard Zone 2**, and then select **•••**.
- 3 Select **Circle**.
- 4 Select the location of the outer guard zone circle.
- 5 Select the location of the inner guard zone circle to define the width of the guard zone.
- 6 Select **Done**.

Defining a Partial Guard Zone

You can define the boundaries of a guard zone that does not completely surround your boat.

- 1 From a radar screen, select **Options > Radar Options > Guard Zones**.
- 2 Select **Guard Zone 1** or **Guard Zone 2**, and then select **...**.
- 3 Drag the cursor to the location of the outer guard-zone corner ①.

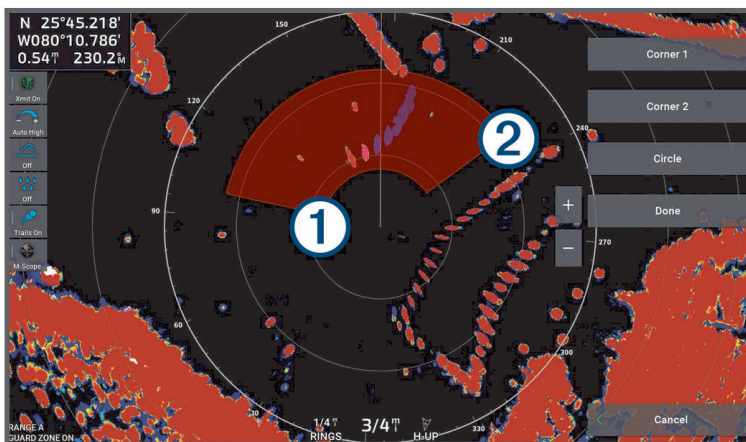

- 4 Select **Corner 2**.
- 5 Drag the cursor to the location of the inner guard-zone corner ② to define the width of the guard zone.
- 6 Select **Done**.

MARPA

⚠ WARNING

This feature is intended to enhance situational awareness and may not prevent collisions in all circumstances. You are responsible for the safe and prudent operation of your vessel and for remaining aware of obstacles or hazards in or around the water. Failure to do so could result in an accident causing property damage, serious personal injury, or death.

Mini-automatic radar plotting aid (MARPA) enables you to identify and track targets and is primarily used for collision avoidance. To use MARPA, you assign a MARPA tag to a target. The radar system automatically tracks the tagged object and provides you with information about the object, including the range, bearing, speed, GPS heading, nearest approach, and time to nearest approach. MARPA indicates the status of each tagged object (acquiring, lost, tracking, or dangerous), and the chartplotter can sound a collision alarm if the object enters your safe zone.

Before you can use MARPA, you must have a heading sensor connected and an active GPS signal. The heading sensor must provide the NMEA 2000® parameter group number (PGN) 127250 or the NMEA® 0183 HDM or HDG output sentence.

MARPA Targeting Symbols

	Acquiring a target. Concentric, dashed green rings radiate from the target while the radar is locking onto it.
	Target has been acquired. A solid green ring indicates the location of a target that the radar has locked onto. A dashed green line attached to the circle indicates the projected course over ground or the GPS heading of the target.
	Dangerous target is in range. A red ring flashes from the target while an alarm sounds and a message banner appears. After the alarm has been acknowledged, a solid red dot with a dashed red line attached to it indicates the location and the projected course over ground or the GPS heading of the target. If the safe-zone collision alarm has been set to Off, the target flashes, but the audible alarm does not sound and the alarm banner does not appear.
	Target has been lost. A solid green ring with an X through it indicates that the radar could not lock onto the target.
	Closest point of approach and time to closest point of approach to a dangerous target.

Acquiring MARPA Targets Automatically

You can acquire MARPA targets automatically based on MotionScope™, guard zones, or boundaries.

- 1 From a radar screen, select **Options > Layers > Other Vessels > MARPA > Auto Acquire**.
- 2 Select **☰**, and adjust additional settings (optional).

Removing MARPA Targets Automatically

You can enable the MARPA Auto Remove setting to remove lost targets from the target list automatically. While enabled, lost targets are removed when new targets are acquired while the target list is at full capacity.

- 1 From a radar screen, select **Options > Layers > Other Vessels > MARPA**.
- 2 Select **Auto Remove > On**.

Assigning a MARPA Tag to an Object

Before you can use MARPA, you must have a heading sensor connected and an active GPS signal. The heading sensor must provide the NMEA 2000® parameter group number (PGN) 127250 or the NMEA® 0183 HDM or HDG output sentence.

- 1 From a radar screen, select an object or location.
- 2 Select **Acquire Tgt. > MARPA Target**.

Removing a MARPA Tag from a Targeted Object

- 1 From the Radar screen, select a MARPA target.
- 2 Select **MARPA Target > Remove**.

Viewing Information about a MARPA-tagged Object

You can view the range, bearing, speed, and other information about a MARPA-tagged object.

- 1 From a radar screen, select a targeted object.
- 2 Select **MARPA Target**.

Viewing a List of AIS Threats

- 1 From a chart or 3D chart view, select **☰ > Layers > Other Vessels > AIS > AIS List**.

TIP: You can quickly access the AIS list from the messages and warnings menu (*Messages and Warnings*, page 168).

- 2 If necessary, select **Display Options** to sort or filter the items in the list.

Showing AIS Vessels on the Radar Screen

AIS requires the use of an external AIS device and active transponder signals from other vessels.

You can configure how other vessels appear on the Radar screen. If any setting (except the AIS display range) is configured for one radar mode, the setting is applied to every other radar mode. The details and projected heading settings configured for one radar mode are applied to every other radar mode and to the Radar overlay.

- 1 From a Radar screen or the Radar overlay, select **Options > Layers > Other Vessels > AIS**.
- 2 Select an option:
 - To indicate the distance from your location within which AIS vessels appear, select **Display Range**, and select a distance.
 - To show details about AIS-activated vessels, select **Details > Show**.
 - To set the projected heading time for AIS-activated vessels, select **Proj. Heading**, and enter the time.
 - To show the tracks of AIS vessels, select **AIS Trails**, and select the length of the track that appears.

Combining the Same MARPA and AIS Target

If you are using both MARPA and AIS, you might notice that sometimes the same target is identified by both systems, which may clutter the radar screen. To prevent this, the chartplotter can combine the targets to reduce the number of items shown at the same time.

- 1 From a radar screen, select **Options > Layers > Other Vessels > Target Association**.

The system evaluates the position, speed, and course of all MARPA and AIS targets, and combines the targets it determines to be the same.
- 2 Select **☰ > Target Display** to set whether the system uses MARPA or AIS to identify the combined target on the screen.

MARPA Dangerous Target Alarm Settings

From a radar screen, select **Options > Layers > Other Vessels > Dangerous Targets**.

Collision Alarm: Turns the collision alarm off and on.

Lost Target Alarm > Range: Sets the maximum distance at which a MARPA target triggers the lost target alarm.

Lost Target Alarm > Speed: Sets the minimum observed speed at which a MARPA target triggers the lost target alarm.

Lost Target Alarm: Turns the lost target alarm off and on.

MARPA Alarm: Turns all MARPA alarms off and on.

Range: Sets the distance at which a MARPA target triggers the collision alarm.

Time To: Adjusts the calculated time to collision at which a MARPA target triggers the collision alarm.

VRM and EBL

The variable range marker (VRM) and the electronic bearing line (EBL) measure the distance and bearing from your boat to a target object. On the Radar screen, the VRM appears as a circle that is centered on the present location of your boat, and the EBL appears as a line that begins at the present location of your boat and intersects the VRM. The point of intersection is the target of the VRM and the EBL.

You can set up to two independent VRM/EBL indicators on the chartplotter radar screen.

Showing and Adjusting a VRM and EBL

You can adjust the diameter of a VRM and the angle of an EBL, which moves the intersection point of the VRM and the EBL. A VRM and EBL configured for one mode are applied to all other radar modes.

- 1 From a radar screen, select **Options > Radar Options > VRM/EBLs**.
- 2 Select **VRM/EBL 1** or **VRM/EBL 2** to enable the VRM/EBL lines on the radar screen.
- 3 To adjust the position of a VRM/EBL target, select **••• > Adjust**, and select a new location for the intersection point of the VRM and the EBL.
- 4 Select **Done**.

Quickly Measuring the Range and Bearing to a Target Object

- 1 From a Radar screen, select the target location.
- 2 Select **VRM/EBLs**.
A list of VRM/EBL options appear.
- 3 Select **Drop VRM/EBL 1** or **Drop VRM/EBL 2**.
The VRM/EBL intersection is set at the target location. The range and bearing to the target location appear in the upper-left corner of the screen.

Changing an EBL Bearing Reference

You can change the bearing reference of the EBL so that it uses the heading of the boat or north.

- 1 From a radar screen, select **Options > Radar Options > VRM/EBLs**.
- 2 If necessary, select **VRM/EBL 1** or **VRM/EBL 2** to enable the VRM/EBL lines on the radar screen.
- 3 Select **••• > EBL Reference** to change the EBL reference.
North uses the cardinal direction of north as a reference, and Relative uses the heading of the vessel as a reference.

NOTE: You can have different EBL Reference settings for each of the VRM/EBLs.

Changing the Origin of a VRM and EBL

You can change the origin of the VRM and EBL lines so that they center on a location other than your vessel.

- 1 From a radar screen, select **Options > Radar Options > VRM/EBLs**.
 - 2 If necessary, select **VRM/EBL 1** or **VRM/EBL 2** to enable the VRM/EBL lines on the radar screen.
 - 3 Select **••• > Set Floating Origin**.
 - 4 Select a location on the radar screen where you want to center the VRM and EBL and select **Done**.
- To return the VRM and EBL so that it is centered on the vessel, select **Reset Floating Origin**.

Using VRM and EBL Quick Actions from the Radar Screen

You can quickly set and adjust VRM and EBLs using shortcuts directly from the radar screen.

- 1 Select an object or location on radar screen and select **VRM/EBLs** from the shortcut menu.
- 2 Select an option to quickly set or adjust a VRM and EBL:

- **Drop VRM/EBL 1** or **Drop VRM/EBL 2**: Sets the intersection point of the VRM and EBL at the selected location.
- **Disable VRM/EBL 1** or **Disable VRM/EBL 2**: Disables the VRM and EBL and clears it from the radar screen.
- **Float VRM/EBL 1** or **Float VRM/EBL 2**: Sets the origin point of the VRM and EBL at the selected location instead of your vessel.
- **Reset VRM/EBL 1 Origin** or **Reset VRM/EBL 2 Origin**: Resets the origin point of the VRM and EBL so it is centered on your vessel.

Echo Trails

The echo trails feature enables you to track the movement of vessels on the radar display. As a vessel moves, you can see a faint trail ① of the vessel's wake. You can change the length of time the trail is displayed.

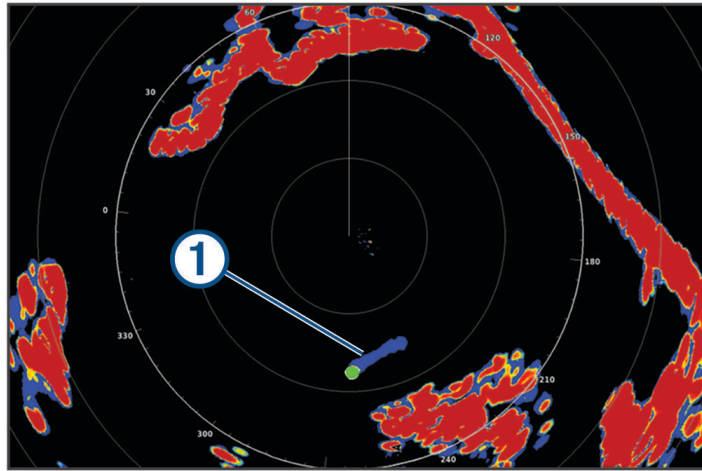

Depending upon the radar in use, the settings configured for use in one radar mode may or may not be applied to other radar modes or to the radar overlay.

This feature is not available on xHD open array or HD/HD+ radome models.

Turning on Echo Trails

From a radar screen, select **Options > Radar Options > Echo Trails > Display**.

Adjusting the Length of the Echo Trails

- 1 From a radar screen or the radar overlay, select **Options > Radar Options > Echo Trails > Time**.
- 2 Select the length of the trail.

Clearing the Echo Trails

You can remove the echo trails from the radar screen to reduce the clutter on the screen.

From a radar screen, select **Options > Radar Options > Echo Trails > Clear Trails**.

Radar Settings

NOTE: Not all options and settings are available on all radar and chartplotter models.

NOTE: You can optimize the radar display for each radar mode.

Radar Gain

Adjusting Gain on the Radar Screen Automatically

The automatic gain setting for each radar mode is optimized for that mode, and may differ from the automatic gain setting used for another mode.

Depending upon the radar in use, the gain setting configured for use in one radar mode may or may not be applied to other radar modes or to the Radar overlay.

Not all options are available on all radar models.

- 1 From a radar screen or the radar overlay, select **Options > Gain**.
- 2 Select an option:
 - To adjust the gain automatically for changing conditions, select **Auto Low** or **Auto High**.
 - To adjust the gain automatically to show birds over the surface of the water, select **Auto Bird**.

This option is not available on xHD open array or HD/HD+ radome models.

Adjusting Gain on the Radar Screen Manually

For optimal radar performance, you can manually adjust the gain.

Depending upon the radar in use, the gain setting configured for use in one radar mode may or may not be applied to other radar modes or to the Radar overlay.

- 1 From a Radar screen or the Radar overlay, select **Options > Gain**.
- 2 Select **Up** to raise the gain, until light speckles appear across the Radar screen.
Data on the Radar screen is refreshed every few seconds. As a result, the effects of manually adjusting the gain may not appear instantly. Adjust the gain slowly.
- 3 Select **Down** to lower the gain until the speckles disappear.
- 4 If boats, land, or other targets are within range, select **Down** to lower the gain until the targets begin to blink.
- 5 Select **Up** to raise the gain until the boats, land, or other targets appear steadily lit on the Radar screen.
- 6 Minimize the appearance of nearby large objects, if necessary.
- 7 Minimize the appearance of side-lobe echoes, if necessary.

Minimizing Nearby Large-Object Interference

Nearby targets of significant size, such as jetty walls, can cause a very bright image of the target to appear on the Radar screen. This image can obscure smaller targets located near it.

Depending upon the radar in use, the gain setting configured for use in one radar mode may or may not be applied to other radar modes or to the Radar overlay.

- 1 From a Radar screen or the Radar overlay, select **Options > Gain**.
- 2 Select **Down** to lower the gain until the smaller targets are clearly visible on the Radar screen.
Reducing the gain to eliminate nearby large-object interference may cause smaller or distant targets to blink or disappear from the Radar screen.

Minimizing Side-Lobe Interference on the Radar Screen

Side-lobe interference may appear to streak outward from a target in a semi-circular pattern. Side-lobe effects can be avoided by reducing the gain or reducing the radar range.

NOTE: Depending upon the radar in use, the gain setting configured for use in one radar mode may or may not be applied to other radar modes or to the Radar overlay.

- 1 From a Radar screen or the Radar overlay, select **Options > Gain**.
- 2 Select **Down** to lower the gain until the semi-circular, streaked pattern disappears from the Radar screen.
Reducing the gain to eliminate side-lobe interference may cause smaller or distant targets to blink or disappear from the Radar screen.

Radar Filter Settings

Adjusting Sea Clutter on the Radar Screen

You can adjust the appearance of clutter caused by choppy sea conditions. The sea clutter setting affects the appearance of nearby clutter and targets more than it affects the appearance of distant clutter and targets. A higher sea clutter setting reduces the appearance of clutter caused by nearby waves, but it can also reduce or eliminate the appearance of nearby targets.

NOTE: Depending upon the radar in use, the sea clutter setting configured for use in one radar mode may or may not be applied to other radar modes or to the radar overlay.

Not all options and settings are available on all radar and chartplotter models.

- 1 From a radar screen or the radar overlay, select **Options > Radar Filters > Sea Clutter**.
- 2 Select an option:
 - Select an **Auto** option based on the sea conditions.
 - Select **Up** or **Down** to adjust the appearance of sea clutter until other targets are clearly visible on the radar screen. Select a setting that reflects the present sea conditions.

Clutter caused by sea conditions may still be visible.

When using a compatible radar model, the chartplotter adjusts the sea clutter based on the sea conditions automatically.

Adjusting Rain Clutter on the Radar Screen

You can adjust the appearance of clutter caused by rain. Reducing the radar range also can minimize rain clutter ([Adjusting the Radar Range, page 109](#)).

The rain clutter setting affects the appearance of nearby rain clutter and targets more than it affects the appearance of distant rain clutter and targets. A higher rain clutter setting reduces the appearance of clutter caused by nearby rain, but it can also reduce or eliminate the appearance of nearby targets.

NOTE: Depending upon the radar in use, the rain clutter settings configured for use in one radar mode may or may not be applied to other radar modes or to the radar overlay.

- 1 From a radar screen, select **Options > Radar Filters > Rain Clutter**.
- 2 Select **Up** or **Down** to decrease or increase the appearance of nearby rain clutter until other targets are clearly visible on the radar screen.
Clutter caused by rain may still be visible.

Averaging Multiple Scans on the Radar Screen

You can average the results of multiple scans on the radar screen. This can be an effective method to filter out noise and enhances the detection of consistent targets. Averaging is most effective when using a longer range.

- 1 From a radar screen or the radar overlay, select **Options > Radar Filters > Scan Average**.
- 2 Select an option.
The High setting filters out the most noise.

Radar Options Menu

From a radar screen, select **Options > Radar Options**.

MotionScope™: Uses the Doppler effect to detect and highlight moving targets to help you avoid potential collisions, find flocks of birds, and track weather formations (*MotionScope™ Doppler Radar Technology, page 110*). This option is only available on GMR Fantom™ models.

Pulse Exp.: Increases the duration of the transmit pulse, which helps maximize the energy directed toward targets. This helps to enhance the detection and identification of targets. This option is only available on xHD radome and xHD2 open array models.

Target Size: Adjusts the size of targets, by adjusting the pulse compression processing. Select smaller targets for a sharp, high resolution radar image. Select larger targets to display larger echos for point targets, like boats and buoys. This option is only available on GMR Fantom models.

Echo Trails: Enables you to track the movement of vessels on the radar screen. This option is not available on xHD open array or HD/HD+ radome models.

VRM/EBLs: Shows the variable range marker (VRM) circle and the electronic bearing line (EBL) to allow you to measure the distance and bearing from your boat to a target object (*VRM and EBL, page 113*).

Guard Zone: Sets a safe zone around your boat and sounds an alarm when anything enters the zone (*Enabling Guard Zones, page 110*).

Timed Transmit: Helps conserve power by transmitting radar signals at set intervals.

Radar Setup Menu

From a radar screen, select **Options > Radar Setup**.

Source: Selects the radar source when more than one radar is connected to the network.

Chart Display: Shows the chart under the radar image. When enabled, the Layers menu appears.

Orientation: Sets the perspective of the radar display.

Crosstalk Rej.: Reduces the appearance of clutter caused by interference from another nearby radar source.

Rotation Spd.: Sets the preferred speed at which the radar rotates. The High Speed option can be used to increase the refresh rate. In some situations, the radar automatically rotates at the normal speed to improve detection, for example, when a longer range is selected or when MotionScope or Dual range is used.

Appearance: Sets the color scheme, look-ahead speed, and navigation appearance.

Installation: Allows you to configure the radar for the installation, such as setting the front of the boat and the antenna park position.

Reducing Cross Talk Clutter on the Radar Screen

You can reduce the appearance of clutter caused by interference from another nearby radar source, when the cross talk reject setting is on.

NOTE: Depending upon the radar in use, the cross talk reject setting configured for use in one radar mode may or may not be applied to other radar modes or to the Radar overlay.

From a radar screen, select **Options > Radar Setup > Crosstalk Rej.**

Radar Appearance Settings

From a radar screen, select **Options > Radar Setup > Appearance**.

These settings do not apply to the radar overlay.

Bkgd. Color: Sets the color for the background.

Frgd. Color: Sets the color scheme for the radar returns.

Brightness: Sets the brightness of various radar features, such as range rings and tracking symbols.

Look-Ahead Speed: Shifts your present location toward the bottom of the screen automatically as your speed increases. Enter your top speed for the best results.

Extended Range Mode: This setting is enabled by default. Turn off to expand the radar view to show all range rings on the radar screen. This is often referred to as Plan Position Indicator (PPI) mode in international radar systems.

Radar Installation Settings

Front of Boat: Compensates for the physical location of the radar when it is not on the boat axis ([Measuring and Setting the Front-of-Boat Offset, page 117](#)).

Antenna Configuration: Sets the radar antenna size and sets the position in which the radar stops ([Setting a Custom Park Position, page 117](#)).

No Transmit Zone: Sets the area in which the radar does not transmit signals ([Enabling and Adjusting a Radar No Transmit Zone, page 109](#)).

Measuring and Setting the Front-of-Boat Offset

The front-of-boat offset compensates for the physical orientation of the radar scanner on a boat, if the radar scanner does not align with the bow-stern axis. The front-of-boat offset setting configured for use in one radar mode is applied to every other radar mode and to the radar overlay.

- 1 Using a magnetic compass, take an optical bearing of a stationary target located within viewable range.
- 2 Measure the target bearing on the radar.
- 3 If the bearing deviation is more than +/- 1 degree, set the front-of-boat offset.
- 4 From a radar screen, select **Options > Radar Setup > Installation > Front of Boat**.
- 5 Select **Up** or **Down** to adjust the offset.

Setting a Custom Park Position

By default, the antenna is stopped perpendicular to the pedestal when it is not spinning. You can adjust this position.

- 1 From the radar screen, select **Options > Radar Setup > Installation > Antenna Configuration > Park Position**.
- 2 Use the slider bar to adjust the position of the antenna when stopped, and select **Back**.

Radar My Vessel Layer Settings

From a radar screen, select **Options > Layers > My Vessel**.

Heading Line: Shows an extension from the bow of the boat in the direction of travel on the radar screen.

Heading Line > Stern Line: Shows an extension from the stern of the boat in the opposite direction of travel on the radar screen.

Range Rings: Shows the range rings that help you to visualize distances on the radar screen.

Bearing Ring: Shows a bearing relative to your heading or based on a north reference, to help you determine the bearing to an object shown on the radar screen.

Radar Overlay Chart Settings

You can quickly access and adjust the chart settings you want to appear on the radar overlay screen. From a radar overlay screen, select **Options > **.

You can access and adjust all available chart settings, which are saved with the radar overlay ([Chart Layers, page 49](#))

Selecting a Different Radar Source

- 1 Select an option:
 - From a radar screen or the radar overlay, select **Options > Radar Setup > Source**.
 - Select  > **Communications > Preferred Sources > Radar**.
- 2 Select the radar source.

Autopilot

⚠ WARNING

You can use the autopilot feature only at a station installed next to a helm, throttle, and helm control device.

You are responsible for the safe and prudent operation of your vessel. The autopilot is a tool that enhances your capability to operate your boat. It does not relieve you of the responsibility of safely operating your boat. Avoid navigational hazards and never leave the helm unattended.

Always be prepared to promptly regain manual control of your boat.

Learn to operate the autopilot on calm and hazard-free open water.

Use caution when operating the autopilot near hazards in the water, such as docks, pilings, and other boats.

The autopilot system continuously adjusts the steering of your boat to maintain a constant heading (heading hold). The system also allows manual steering and several modes of automatic-steering functions and patterns.

When the chartplotter is connected to a compatible Garmin® autopilot system, you can engage and control the autopilot from the chartplotter. For information about compatible Garmin autopilot systems, go to garmin.com.

When the chartplotter is connected to a compatible Yamaha® autopilot system, you can control the autopilot from the chartplotter using the Yamaha autopilot screen and overlay bar (*Yamaha® Autopilot, page 125*). For information about compatible Yamaha autopilot systems, contact your Yamaha dealer.

Autopilot Configuration

NOTICE

To avoid damage to your boat, the autopilot system should be installed and configured by a qualified marine installer. Specific knowledge of marine steering and electrical systems is required for proper installation and configuration.

The autopilot system must be configured to work properly with your boat. You can configure the autopilot using a chartplotter on the same NMEA 2000® network as the autopilot. For configuration instructions, go to support.garmin.com, and download the configuration guide for your specific autopilot model.

Selecting the Preferred Heading Source

NOTICE

For best results, use the autopilot CCU internal compass for the heading source. Using a third-party GPS compass can cause the data to be delivered erratically and may result in excessive delays. The autopilot needs timely information, and therefore cannot often use third-party GPS compass data for GPS location or speed. If a third-party GPS compass is used, the autopilot will likely report loss of navigation data and speed source periodically.

If you have more than one heading source on the network, you can select a your preferred source. The source could be a compatible GPS compass or a magnetic heading sensor.

- 1 From the autopilot screen, select **Options > Autopilot Setup > Preferred Sources**
- 2 Select a source.

If the selected heading source is unavailable, the autopilot screen does not display any data.

Opening the Autopilot Screen

Before you can open the autopilot screen, you must have a compatible Garmin® autopilot installed and configured.

Select **Vessel > Autopilot**.

Autopilot Screen

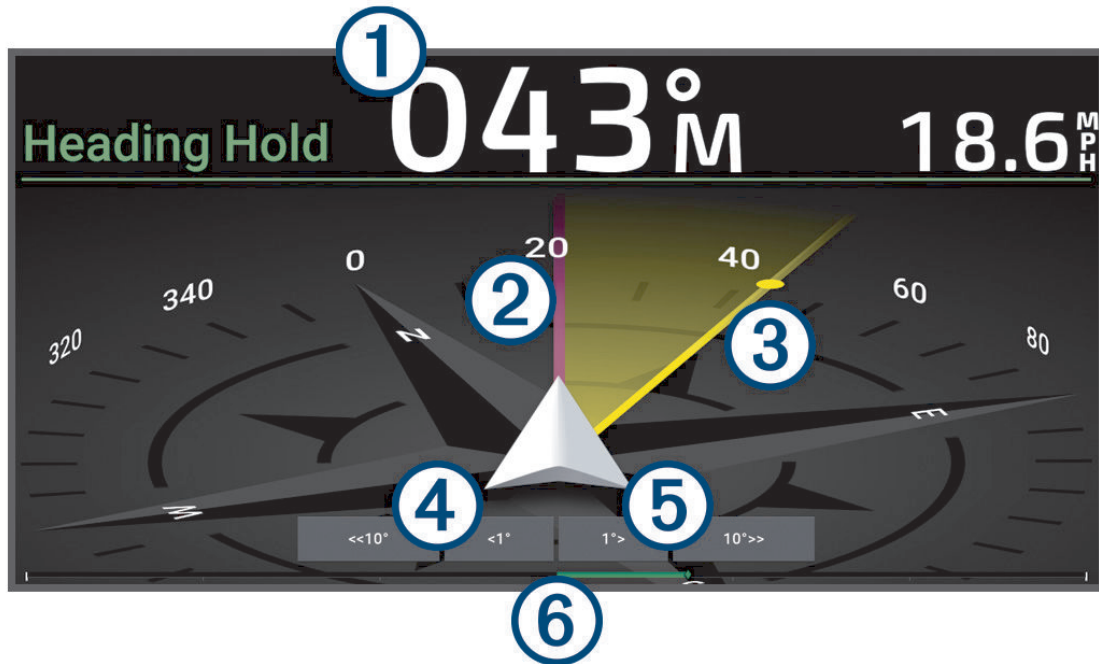

①	Actual heading (when in standby mode) Intended heading (when engaged)
②	Actual heading
③	Intended heading (heading the autopilot is steering toward)
④	Step turn to port (to adjust the intended heading by amount shown)
⑤	Step turn to starboard (to adjust the intended heading by amount shown)
⑥	Rudder position indicator (available when a rudder sensor is connected)

Adjusting the Step Steering Increment

- 1 From the autopilot screen, select **Options > Autopilot Setup > Step Turn Size**.
- 2 Select an increment.

Setting the Power Saver

You can adjust the level of rudder activity.

- 1 From the autopilot screen, select **Options > Autopilot Setup > Power Mode Setup > Power Saver**.
- 2 Select a percentage.

Selecting a higher percentage reduces rudder activity and heading performance. The higher the percentage, the more the course deviates before the autopilot corrects it.

TIP: In choppy conditions at low speeds, increasing the Power Saver percentage reduces rudder activity.

Enabling the Shadow Drive™ Feature

⚠ WARNING

If the Shadow Drive feature is disabled, steering the boat manually will not disengage the autopilot system. You must use the helm control or connected chartplotter to disengage the autopilot system.

NOTE: The Shadow Drive feature is not available on all autopilot models.

If the Shadow Drive feature has been disabled, you must enable it again before you can steer the boat manually to disengage the autopilot system.

- 1 From the autopilot screen, select **Options > Autopilot Setup > Shadow Drive Setup**.
- 2 If **Disabled** is shown, select **Shadow Drive** to enable the Shadow Drive feature.

The Shadow Drive feature is enabled. You can repeat these steps to disable the feature again.

Autopilot Overlay Bar

NOTE: Not all options are available on all autopilot models.

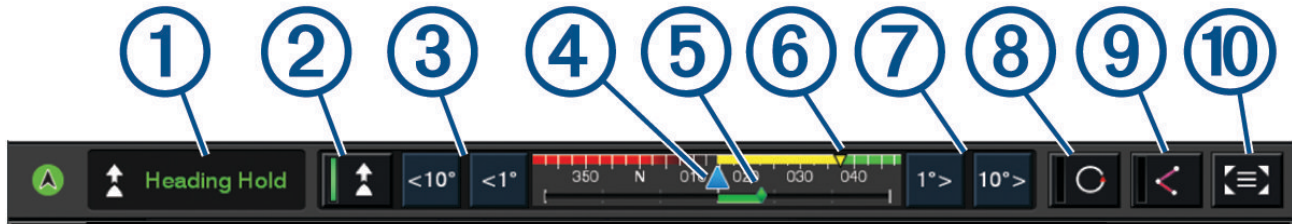

①	Autopilot status
②	Engages and disengages heading hold
③	Steers left
④	Actual heading
⑤	Rudder position indicator (available only when a rudder sensor is connected)
⑥	Intended heading (heading the autopilot is steering toward)
⑦	Steers right
⑧	Engages the last used steering pattern
⑨	Engages follow route mode (available only when autopilot is in standby status and navigating using Go To, Route To, or Auto Guidance)
⑩	Opens the full autopilot screen and menu

Engaging the Autopilot

When you engage the autopilot, the autopilot takes control of the helm and steers the boat to maintain your heading.

From any screen, select **Engage**.

Your intended heading shows in the center of the Autopilot screen.

Adjusting the Heading Using the Helm

NOTE: You must enable the Shadow Drive™ feature before you can adjust the heading using the helm while the autopilot is engaged .

With the autopilot engaged, manually steer the boat using the helm.

Shadow Drive and  at the top of the heading screen appear in yellow, and you have full steering control using the helm.

When you release the helm and maintain a specific heading for a few seconds, the autopilot resumes a heading hold at the new heading.

Adjusting the Heading with the Chartplotter in Step Steering Mode

1 Engage a heading hold ([Engaging the Autopilot, page 120](#)).

2 Select an option:

- Select <1° or 1°> to initiate a single 1° turn.
- Select <<10° or 10°>> to initiate a single 10° turn.
- Hold <1° or 1°> to initiate a rate-controlled turn.
The boat continues to turn until you let go of the key.
- Hold <<10° or 10°>> to initiate a sequence of 10° turns.

Autopilot Navigation

CAUTION

You must use this feature with extreme care on a sailboat. Following a route while under sail can cause an unexpected gybe maneuver. Unattended sails and rigging can be damaged or cause injury to any crew or passengers during an unexpected gybe maneuver.

When you start navigation (Go To, Route To, or Guide To), if you are connected through a NMEA 2000® network to a compatible Garmin® autopilot, you are prompted to engage the autopilot.

When using the autopilot system to follow a route from the chartplotter, observe these considerations:

- You should take care and reduce speed when approaching a turn on a route. Entering a turn while moving too fast may cause you to overshoot the point and make a wider turn than you intended.
- Due to how the software follows a route on the chartplotter, the system may transition to the next turn in a route sooner than expected. You must remain alert so you can take over if the system makes an unexpected change.
- When using the autopilot system on a sailboat, you should avoid following a route when sailing on Broad Reach or Run. The system automatically steers the boat port or starboard to stay on route, and when sailing downwind, this may result in an unintended gybe as mentioned in the caution above.

Steering Patterns

WARNING

You are responsible for the safe operation of your boat. Do not begin a pattern until you are certain the water is clear of obstacles.

The autopilot can steer the boat in preset patterns for fishing, and it can perform other specialty maneuvers such as U-turns and Williamson turns.

Following the U-Turn Pattern

You can use the u-turn pattern to turn the boat around 180 degrees and maintain the new heading.

- 1 From the autopilot screen, select **Options > Pattern Steering > U-Turn**.
- 2 Select **Engage Port** or **Engage Starboard**.

Setting Up and Following the Circles Pattern

You can use the circles pattern to steer the boat in a continuous circle, in a specified direction, and at a specified time interval.

- 1 From the autopilot screen, select **Options > Pattern Steering > Circles**.
- 2 If necessary, select **Time**, and select a time for the autopilot to steer one complete circle.
- 3 Select **Engage Port** or **Engage Starboard**.

Setting Up and Following the Zigzag Pattern

You can use the zigzag pattern to steer the boat from port to starboard and back, over a specified time and angle, across your present heading.

- 1 From the autopilot screen, select **Options > Pattern Steering > Zigzag**.
- 2 If necessary, select **Amplitude**, and select a degree.
- 3 If necessary, select **Period**, and select a length of time.
- 4 Select **Engage Zigzag**.

Following the Williamson Turn Pattern

You can use the Williamson turn pattern to steer the boat around with the intent of running alongside the location where the Williamson turn pattern was initiated. The Williamson turn pattern can be used in many overboard situations.

- 1 From the autopilot screen, select **Options > Pattern Steering > Williamson Turn**.
- 2 Select **Engage Port** or **Engage Starboard**.

Following an Orbit Pattern

You can use the orbit pattern to steer the boat in a continuous circle around the active waypoint. The size of the circle is defined by your distance from the active waypoint when you begin the orbit pattern.

- 1 From the autopilot screen, select **Options > Pattern Steering > Orbit**.
- 2 Select **Engage Port** or **Engage Starboard**.

Setting Up and Following the Cloverleaf Pattern

You can use the cloverleaf pattern to steer the boat to repeatedly pass over an active waypoint. When you begin the cloverleaf pattern, the autopilot drives the boat toward the active waypoint and begins the cloverleaf pattern. You can adjust the distance between the waypoint and the location where the autopilot turns the boat for another pass over the waypoint. The default setting turns the boat at a range of 1000 ft. (300 m) from the active waypoint.

- 1 From the autopilot screen, select **Options > Pattern Steering > Cloverleaf**.
- 2 If necessary, select **Length**, and select a distance.
- 3 Select **Engage Port** or **Engage Starboard**.

Setting Up and Following a Search Pattern

You can use the search pattern to steer the boat in increasingly larger circles outward from the active waypoint, forming a spiral pattern. When you begin the search pattern, the autopilot immediately drives the boat in a circle centered on the active waypoint and expands the spiral as it completes each circle.

You can adjust the distance between each circle in the spiral. The default distance between circles is 50 ft. (20 m).

- 1 From the autopilot screen, select **Options > Pattern Steering > Search**.
- 2 If necessary, select **Search Spacing**, and select a distance.
- 3 Select **Engage Port** or **Engage Starboard**.

Cancelling a Steering Pattern

- Physically steer the boat.
 - NOTE:** Shadow Drive™ feature must be enabled to cancel a steering pattern by physically steering the boat.
- Select **<** or **>** to cancel a pattern using step steering mode.
- Select **Standby**.

Adjusting the Autopilot Response

The Response setting allows you to adjust the autopilot responsiveness for varying sea and wind conditions. For advanced autopilot configuration, see the configuration guide included with your autopilot system.

- 1 From the autopilot screen, select **Options > Response**.
- 2 Adjust the rudder response.
 - If you want the rudder to be more responsive and move more quickly, increase the value. If the rudder is too responsive and moving too quickly, decrease the value.

Enabling Auto Response

When using the autopilot system on a Sailboat or a Sailing Catamaran vessel, you can set the response setting to Auto so that the autopilot system automatically adjusts the response setting based on sea conditions. The Auto setting automatically lowers the response setting to Low (4) in calm sea conditions, and raises it to Normal in rough sea conditions. The autopilot system uses pitch and roll information to determine sea conditions, as well as wind data, if available.

- 1 From the autopilot screen, select **Options > Response**.
- 2 Select **Auto** repeatedly until it shows the preferred sensitivity level, **Low** through **High**.
 - The response setting will adjust automatically based on sea conditions. The higher you set the auto response setting, the system will be more sensitive to pitch, roll, and wind data when adjusting the response.

Low-Speed Autopilot Mode

If you operate the autopilot system at very low speeds, when trolling for example, you can enable a low-speed mode that is more responsive in these situations.

The low-speed autopilot mode must be enabled before you can use it, and is available only for Power Planing Hull or Power Displacement Hull vessels with the Speed Source set to GPS.

Enabling and Disabling Low-Speed Autopilot Mode

By default, the low-speed autopilot mode is disabled, and you must enable it in the autopilot settings before you can use it.

- 1 From the autopilot screen, select **Options > Autopilot Setup > Autopilot Installation Setup > Speed Source Setup**.
- 2 Select **Autopilot Low Speed**.

Low-speed autopilot mode is enabled.

- 3 Select **Autopilot Low Speed** again to disable low-speed autopilot mode.

Engaging and Disengaging Low Speed Autopilot Mode

You must enable low-speed autopilot mode in the Autopilot Installation Setup menu before you can engage low-speed autopilot mode.

- 1 When driving the boat at a low speed (under 1 kn.), engage the heading hold.
A message banner appears asking if you would like to engage the low-speed autopilot heading hold.
- 2 Select **Low Speed** to engage low-speed mode.
If you select Cancel or do nothing, the autopilot remains in normal heading hold.
The autopilot system operates with increased sensitivity and reaction for better performance at low speeds.
- 3 To disengage low-speed mode, disengage the autopilot or increase the boat speed above 12 kn.

Enabling the Autopilot Controls on a Garmin® Watch

You can control the Garmin autopilot with a compatible Garmin watch. Go to garmin.com for a list of compatible Garmin devices. For more information, see the owner's manual for your compatible Garmin watch.

NOTE: Smart notifications are not available on your watch when the autopilot remote control is enabled.

TIP: In addition to controlling an autopilot system, you can also use a compatible Garmin watch to control or view other features on the chartplotter:

- You can use the screen and buttons as a remote control to navigate the user interface (*Pairing a Garmin® Watch to Control a Garmin Chartplotter, page 38*).
- You can send voice commands and hear replies through the watch (*Pairing a Garmin® Watch with a Garmin Chartplotter for Voice Control, page 27*).
- You can view important data about your boat, such as depth and speed (*Viewing Boat Data on a Garmin® Watch, page 38*).

- 1 Select **Communications > Wireless Devices > Wearables > Autopilot Control > Enable > New Connection**.
- 2 Follow the on-screen instructions.

Customizing the Autopilot Button Actions

Before you can set the autopilot button actions, you must install and configure a compatible Garmin® autopilot. You can select up to three autopilot actions for your Garmin watch to perform.

NOTE: Available autopilot actions depend on the autopilot installed.

- 1 On the chartplotter, select **Communications > Wireless Devices > Wearables > Autopilot Control > Button Actions**.
- 2 Select a button.
- 3 Select an action.

Controlling the Autopilot with a GRID™ 20 Remote Control

NOTE: You can control the autopilot with a GRID 20 remote control only when the steering buttons are visible on the screen. When including the autopilot screen as part of a combo, you may have to click on the autopilot window in the combo to make it full screen before you are able to use the GRID 20 remote control.

- Press the knob to change the mode.
- While in step steering mode, turn the knob to steer.
Each turn of the knob produces a 1-degree step turn.
- While in autopilot response mode, turn the knob to adjust the **Response** setting.
- While in rudder steering mode, hold the joystick to the right or left to steer.

Reactor™ Autopilot Remote Control

WARNING

You are responsible for the safe and prudent operation of your vessel. The autopilot is a tool that enhances your capability to operate your boat. It does not relieve you of the responsibility of safely operating your boat. Avoid navigational hazards and never leave the helm unattended.

You can wirelessly connect a Reactor autopilot remote control to the chartplotter to control the compatible Reactor autopilot system.

For more information about using the remote, see the Reactor autopilot remote control instructions at garmin.com

Pairing a Reactor™ Autopilot Remote Control With a Chartplotter

- 1 Select **Options > Communications > Wireless Devices > Wireless Remotes > Autopilot Remote**.
- 2 If necessary, select **Enable**.
- 3 Select **New Connection**.
- 4 On the remote control, select **☰ > Pair with MFD**.
The chartplotter beeps and shows a confirmation message.
- 5 On the chartplotter, select **Yes** to complete the pairing process.

Changing the Functions of the Reactor™ Autopilot Remote Control Action Keys

You can change the patterns or actions assigned to the Reactor autopilot remote control action keys.

- 1 Select **⚙ > Communications > Wireless Devices > Wireless Remotes > Autopilot Remote > Button Actions**.
- 2 Select an action key to change.
- 3 Select a pattern or action to assign to the action key.

Updating the Reactor™ Autopilot Remote Control Software

You can update the Reactor autopilot remote control software using the chartplotter.

- 1 Insert a memory card into the card slot on the computer.
- 2 Go to garmin.com/software/autopilot_remote_control, and select **Software**.
- 3 Select **Download**.
- 4 Read and agree to the terms.
- 5 Select **Download**.
- 6 Choose a location, and select **Save**.
- 7 Double-click the downloaded file.
- 8 Select **Next**.
- 9 Select the drive associated with the memory card, and select **Next > Finish**.
- 10 On the chartplotter, insert the memory card into the card slot.
- 11 Select **⚙ > Communications > Wireless Devices > Autopilot Remote > Update Software**.

Autopilot Keypad

WARNING

You are responsible for the safe and prudent operation of your vessel. The autopilot is a tool that enhances your capability to operate your boat. It does not relieve you of the responsibility of safely operating your boat. Avoid navigational hazards and never leave the helm unattended.

You can connect a APK™ 10 autopilot keypad to the same NMEA 2000® network as the chartplotter to control the compatible Reactor™ autopilot system.

For more information about installing and using the keypad, see the APK 10 autopilot keypad instructions at garmin.com

Function Key Default Actions

The two function keys are programmed with default actions based on the vessel type.

Vessel Type	Function Key 1	Function Key 2
Power Planing Hull and Power Displacement Hull	Circle (pattern)	Route Follow
Sailing and Sailing Catamaran	Tack/Gybe	Wind Hold

Configuring the Function Keys

The two keys labeled 1 and 2 on the keypad can be configured using a compatible chartplotter or a GHC™ 50 helm control connected to the autopilot system.

- 1 From the autopilot screen, select **Options > Autopilot Setup > Autopilot Keypad > Autopilot Keypad Configuration**
- 2 Select an option:
 - To configure the key labeled 1, select **Key 1**.

- To configure the key labeled **2**, select **Key 2**.
- 3 Select the function you want to assign to the key.
 - 4 Repeat this procedure for the other key, if needed.

Power Steering Mode

CAUTION

When using a jog lever in power steering mode, the autopilot system does not establish a heading hold. You are responsible for the safe operation of your boat.

When using a GNA™ 10 adapter to connect a jog lever to an autopilot system installed on a power displacement hull vessel, you can enable an optional power steering mode to use the jog lever to steer the vessel with no autopilot intervention. When using the jog lever in power steering mode, it behaves differently than using it in the standard autopilot heading hold or when using the autopilot to follow a route.

When using a jog lever while in standard autopilot heading hold, pressing or holding the jog lever port or starboard turns the boat until you release the jog lever. The autopilot system then resumes a heading hold for your new heading, making adjustments as needed to maintain the new heading.

When using a jog lever while following a route using the autopilot system, pressing or holding the jog lever port or starboard stops following the route and turns the boat until you release the jog lever. The autopilot system then resumes a heading hold for your new heading, making adjustments as needed to maintain the new heading. It does not resume the initial route.

When using the jog lever while in power steering mode, pressing or holding the jog lever port or starboard turns the boat until you release the jog lever. The autopilot system does not establish a heading hold and the rudder stays in the position where you released the jog lever.

Enabling Power Steering Mode

Before you can select the option to Engage Power Steering on the chartplotter or helm control device, you must first enable power steering mode in the autopilot settings.

NOTE: The option to enable power steering mode is available only when the GNA™ 10 adapter is installed correctly and the vessel type is set to power planing.

From the autopilot page, select **••• > Autopilot Setup > Power Steering**.

The Power Steering setting is enabled, and the option to Engage Power Steering is now available in the autopilot menu.

Yamaha® Autopilot

WARNING

You can use the autopilot feature only at a station installed next to a helm, throttle, and helm control device.

You are responsible for the safe and prudent operation of your vessel. The autopilot is a tool that enhances your capability to operate your boat. It does not relieve you of the responsibility of safely operating your boat. Avoid navigational hazards and never leave the helm unattended.

Always be prepared to promptly regain manual control of your boat.

Learn to operate the autopilot on calm and hazard-free open water.

Use caution when operating the autopilot near hazards in the water, such as docks, pilings, and other boats.

The autopilot system continuously adjusts the steering of your boat to maintain a constant heading (heading hold).

When the chartplotter is connected to a compatible Yamaha autopilot system, you can view the autopilot information using the Yamaha autopilot screen and overlay bar. For information about compatible Yamaha autopilot systems, contact your Yamaha dealer.

Yamaha® Autopilot Screen

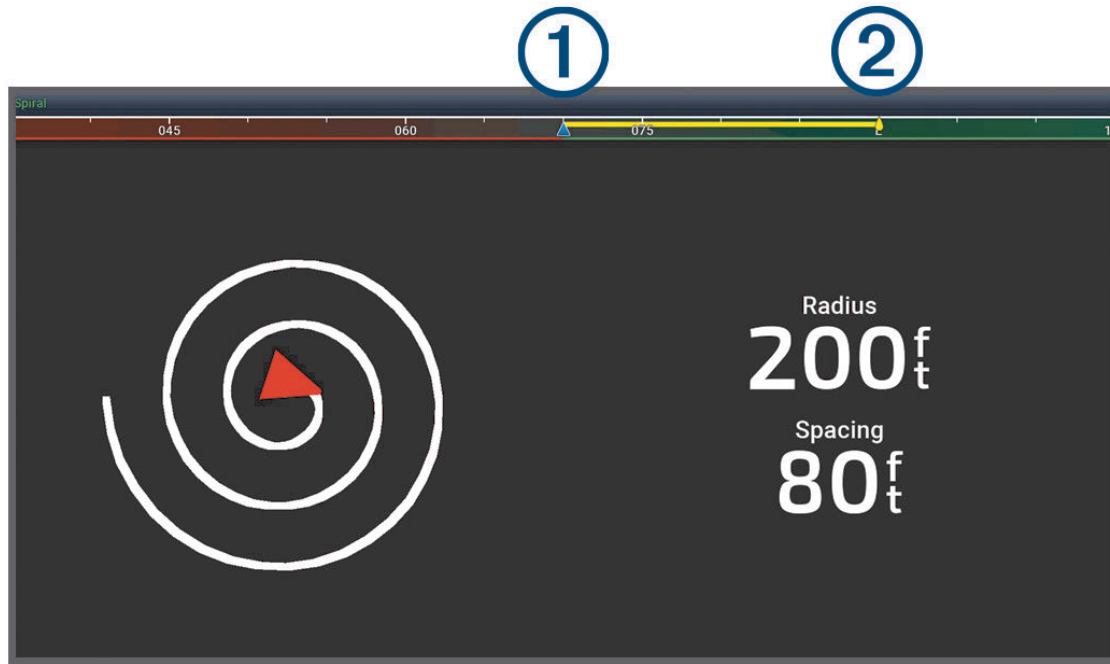

①	Actual heading
②	Intended heading (heading the autopilot is steering toward)

Yamaha® Autopilot Settings

From a Yamaha engine screen, select **Options > Autopilot Setting**.

Pattern Set: Allows you to select an autopilot pattern.

Direction: Sets a port or starboard direction for the pattern.

Spacing: Sets the spacing for the pattern.

Length: Sets the length of the pattern.

Amplitude: Sets the angle for the zigzag pattern.

Initial Radius: Sets the radius of the spiral pattern.

Final Track Point Mode: Sets the mode for the autopilot when it reaches the end of a route. The FishPoint® option maintains the position, but does not maintain the heading. The DriftPoint® option allows the boat to drift with the wind or current while maintaining the selected heading, but does not maintain the position. The StayPoint® option maintains the position and the heading. The Deceleration option stops the motor, but does not maintain the position or heading. The No Deceleration option does not stop the motor.

Course Hold Offset: Sets a distance to navigate parallel to a route.

NOTE: Detailed information on the operation of the Yamaha Joystick and Autopilot system can be found in the *Quick Guide* included with the latest Joystick/Autopilot kit.

Yamaha® Autopilot Overlay Bar

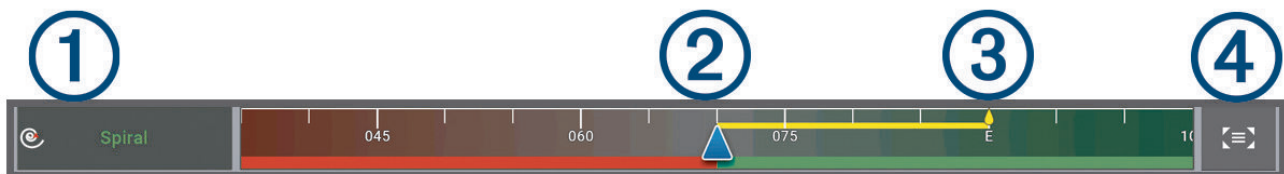

①	Autopilot mode
②	Actual heading

③	Intended heading (heading the autopilot is steering toward)
④	Opens the full autopilot screen and menu

Force® Trolling Motor Control

⚠ WARNING

Do not run the motor when the propeller is out of the water. Contact with the rotating propeller may result in severe injury.

Do not use the motor in areas where you or other people in the water may come into contact with the rotating propeller, which could result in severe injury.

Always disconnect the motor from the battery before handling or working with the propeller, propeller drive motor, electrical connections, or electronics enclosures to avoid serious injury or death.

You are responsible for the safe and prudent operation of your vessel. The autopilot features on the trolling motor are tools that enhance your capability to operate your boat. They do not relieve you of the responsibility of safely operating your boat. Avoid navigational hazards and never leave the motor controls unattended.

Learn to operate the autopilot on calm and hazard-free open water.

Use caution when operating the autopilot near hazards in the water, such as docks, pilings, and other boats.

⚠ CAUTION



When using the autopilot features, be prepared for sudden stops, acceleration, and turns.

When stowing or deploying the motor, maintain stable footing and be aware of slick surfaces around the motor. Losing your footing while stowing or deploying the motor may result in injury.

You can connect the Force trolling motor to the chartplotter to view and control the motor using the chartplotter.

Connecting to a Trolling Motor

You can connect the chartplotter wirelessly to a compatible Garmin® Force® trolling motor on your boat to control the trolling motor from the chartplotter.

- 1 Turn on the chartplotter and the trolling motor.
- 2 Enable the Wi-Fi® network on the chartplotter (*Setting Up the Wi-Fi® Network, page 37*).
- 3 If multiple chartplotters are connected on the Garmin Marine Network, make sure this chartplotter is the host of the Wi-Fi network (*Changing the Wi-Fi® Host, page 37*).
- 4 On the chartplotter, select  > **Communications** > **Wireless Devices** > **Garmin Trolling Motor**.
- 5 On the trolling motor display panel, press  three times to enter pairing mode.
 on the trolling motor display panel is solid blue as it searches for a connection to the chartplotter, and turns green when the connection is successful.

After the chartplotter and trolling motor connect successfully, enable the trolling motor overlay bar to control the motor (*Adding the Trolling Motor Controls to Screens, page 128*).

Adding the Trolling Motor Controls to Screens

After you have connected the chartplotter to the Force® trolling motor, you must add the trolling motor control bar to screens to control the trolling motor.

- 1 Open a screen from which you would like to control the trolling motor.
- 2 Select an option:
 - From a full screen, select **Options** > **Edit Overlays**.
 - From a combination screen, select **Options** > **Edit** > **Overlays**.
- 3 Select **Top Bar**, **Bottom Bar**, **Left Bar**, or **Right Bar**.
- 4 Select **Trolling Motor Bar**.

Repeat these steps to add the trolling motor controls to all of the screens from which you would like to control the trolling motor.

Trolling Motor Control Bar

The trolling motor control bar allows you to control a Force® trolling motor and see the status of the motor. Select an item to engage it. The button illuminates when selected. Select the item again to disengage it.

1

2



	Trolling motor battery status.
	Turns the propeller on and off.
	Reduces the speed. When the speed reaches 0, continuing to reduce the speed shifts the propeller into reverse thrust.
①	Speed indicator.
	Increases the speed. If you are running the propeller in reverse thrust, increasing the speed past 0 shifts the propeller into forward thrust.
	Enables the cruise control at the current speed over ground (SOG).
	Engages the propeller at full speed.
②	Trolling motor status.
	Enables anchor lock, which uses the trolling motor to hold your position.
	Steers the trolling motor. When in anchor lock, jogs the anchor lock position forward, backward, left, or right.
	Enables heading hold (set and maintain the current heading). When the trolling motor is in heading hold, an autopilot bar appears in the trolling motor bar.
R↓	Shifts between forward and reverse mode. NOTE: When shifting between forward and reverse mode, the propeller speed is automatically set to the last speed you used in the same thrust mode. Shifting between forward and reverse thrust automatically turns the propeller off. Shifting between forward and reverse thrust while in an autopilot mode automatically reverts the motor to manual mode.
	Opens the trolling motor settings.

Reverse Thrust

In manual mode, you can run the propeller in reverse. Running the propeller in reverse for short periods of time can be useful in some situations, such as backing out of a tight space with less steering of the motor. Because the propeller on the trolling motor is designed primarily for forward thrust, it is less efficient at creating reverse thrust, resulting in more noise from the motor, especially at higher propeller speeds, and more turbulence underwater.

NOTICE

You should use reverse thrust sparingly to minimize cavitation and excessive wear on the propeller and the propeller drive motor.

Trolling Motor Settings

From the trolling motor bar, select .

Calibrate: Calibrates the trolling motor compass ([Calibrating the Trolling Motor Compass, page 130](#)) and sets the trolling motor bow offset ([Setting the Bow Offset, page 130](#)).

Anchor Gain: Sets the response of the trolling motor when in anchor lock mode. If you need the trolling motor to be more responsive and move quicker, increase the value. If the motor is moving too much, decrease the value.

Navigation Gain: Sets the response of the trolling motor when navigating. If you need the trolling motor to be more responsive and move quicker, increase the value. If the motor is moving too much, decrease the value.

Heading Hold Mode: Sets the heading hold mode. The Vessel Align option attempts to keep the boat pointing in the same direction regardless of drift. The Go To option attempts to navigate a straight line in the requested direction.

Arrival Mode: Sets the behavior of the trolling motor when you reach the end of a route. With the Anchor Lock setting, the trolling motor holds the position using the anchor lock feature when the boat reaches the end of the route. With the Manual setting, the propeller turns off when the boat reaches the end of the route.

⚠ CAUTION

You are responsible for the safe operation of your boat. When using the Manual setting for the Arrival Mode option, you must be ready to take control of the boat.

Auto Power On: Turns on the trolling motor when you apply power to the system.

Prop. Stow Side: Sets which side of the trolling motor the propeller rotates to when stowing the trolling motor. This is helpful when you store other items near the stowed propeller.

Shortcut Keys: Enables the shortcut keys on the trolling motor remote control to work with this particular chartplotter. The keys work with only one chartplotter at a time.

Restore Defaults: Resets the trolling motor settings to the factory default values.

Assigning a Shortcut to the Trolling Motor Remote Control Shortcut Keys

You can quickly open commonly used screens by assigning a shortcut key on the trolling motor remote control. You can create a shortcut to screens, such as sonar screens and charts.

NOTE: If you have more than one chartplotter on the network, you can assign shortcut keys to one chartplotter only.

- 1 Open a screen.
- 2 Hold a shortcut key.

TIP: The shortcut is also saved to the Pinned category with the shortcut key number.

Calibrating the Trolling Motor Compass

You must calibrate the compass in the trolling motor before you can use the autopilot features.

- 1 Drive the boat to an open area of calm water.
- 2 From the trolling motor bar, select  > **Calibrate** > **Compass Cal..**
- 3 Follow the on-screen instructions.

Setting the Bow Offset

Based on the installation angle, the trolling motor may not align with the center line of your boat. For the best results, you should set the bow offset.

- 1 Adjust the angle of the trolling motor  so it aligns with the center line of your boat , pointing straight forward.

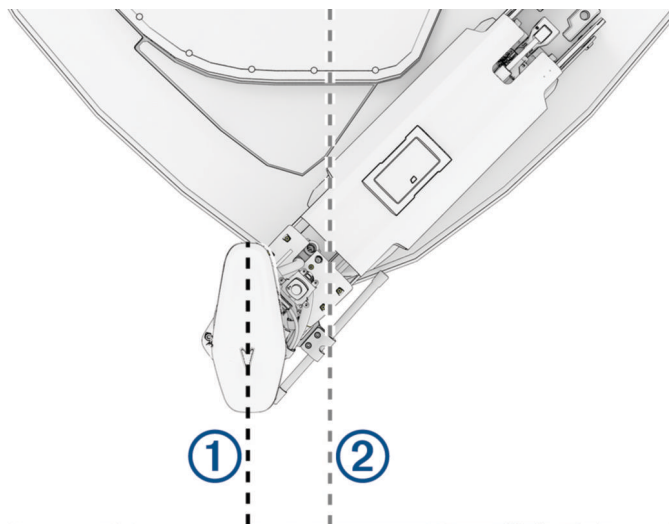

- 2 From the trolling motor bar, select  > **Calibrate** > **Bow Offset**.

Calibrating the Steering Alignment

The Garmin® trolling motor shaft is aligned at the factory by Garmin, and should not need regular alignment. Occasionally, due to an impact or an unexpected manual shaft rotation, the trolling motor steering may appear off, or you may receive an error message regarding the steering alignment. You can perform this alignment procedure to correct this type of error.

- 1 Deploy the trolling motor.
- 2 From the trolling motor bar, select  > **Calibrate** > **Steering Alignment**.
- 3 Follow the on-screen instructions and select **Begin**.

NOTICE

The trolling motor will perform a number of steering motions during the calibration process.

- 4 Wait until the calibration process is complete.

Digital Selective Calling

Networked Chartplotter and VHF Radio Functionality

When you connect a compatible VHF radio to your chartplotter, these features are enabled.

- The chartplotter can transfer your GPS position to your radio. If your radio is capable, GPS position information is transmitted with DSC calls.
- The chartplotter can receive digital selective calling (DSC) distress and position information from the radio.
- The chartplotter can track the positions of vessels sending position reports.

If you have a Garmin® NMEA 2000® VHF radio connected to your chartplotter, these features are also enabled.

- The chartplotter allows you to quickly set up and send individual routine call details to your Garmin VHF radio.
- When you initiate a man-overboard distress call from your radio, the chartplotter shows the man-overboard screen and prompts you to navigate to the man-overboard point.
- When you initiate a man-overboard distress call from your chartplotter, the radio shows the Distress Call page to initiate a man-overboard distress call.
- You can initiate other SOS calls on the chartplotter and send them using the radio.

For information about installing and connecting a VHF radio, see the VHF radio installation instructions.

Turning On DSC

Select  > **Other Vessels** > **DSC**.

DSC List

The DSC list is a log of the most recent DSC calls and other DSC contacts you have entered. The DSC list can contain up to 100 entries. The DSC list shows the most recent call from a boat. If a second call is received from the same boat, it replaces the first call in the call list.

You can view the DSC list from the messages and warnings menu ([Messages and Warnings, page 168](#)).

Viewing the DSC List

Before you can view the DSC list, the chartplotter must be connected to a VHF radio that supports DSC.

From a chart or 3D chart view, select **•••** > **Layers** > **Other Vessels** > **DSC** > **DSC List**.

TIP: You can quickly access the DSC list from the messages and warnings menu ([Messages and Warnings, page 168](#)).

Adding a DSC Contact

You can add a vessel to your DSC list. You can make calls to a DSC contact from the chartplotter.

- 1 From a chart or 3D chart view, select **•••** > **Layers** > **Other Vessels** > **DSC** > **DSC List** > **Add Contact**.

TIP: You can quickly access the DSC list from the messages and warnings menu ([Messages and Warnings, page 168](#)).

- 2 Enter the Maritime Mobile Service Identity (MMSI) of the vessel.
- 3 Enter the name of the vessel.

Incoming Distress Calls

If your chartplotter is connected to a compatible VHF radio, your chartplotter alerts you when your VHF radio receives a DSC distress call. If position information was sent with the distress call, that information is also available and recorded with the call.

 designates a distress call in the DSC list and marks the position of the vessel on the Navigation chart at the time of the DSC distress call.

Navigating to a Vessel in Distress

The  icon designates a distress call in the DSC list and marks the position of a vessel on the Navigation chart at the time of the DSC distress call.

- 1 From a chart or 3D chart view, select **•••** > **Layers** > **Other Vessels** > **DSC** > **DSC List**.

TIP: You can quickly access the DSC list from the messages and warnings menu ([Messages and Warnings, page 168](#)).

- 2 Select a position-report call.
- 3 Select **Review** > **Navigate To**.

4 Select **Go To** or **Route To**.

Man-Overboard Distress Calls Initiated from a VHF Radio

When the chartplotter is connected to a compatible VHF radio with NMEA 2000®, and you initiate a man-overboard DSC distress call from the radio, the chartplotter shows the man-overboard screen and prompts you to navigate to the man-overboard point. If you have a compatible autopilot system connected to the network, the chartplotter prompts you to start a Williamson's turn to the man-overboard point.

If you cancel the man-overboard distress call on the radio, the chartplotter screen prompting you to activate navigation to the man-overboard location disappears.

Man-Overboard and SOS Distress Calls Initiated from the Chartplotter

When your chartplotter is connected to a Garmin® NMEA 2000® compatible radio and you mark an SOS or man-overboard location, the radio shows the Distress Call page so you can quickly initiate a distress call.

For information on placing distress calls from your radio, see the VHF radio owner's manual. For information about marking an MOB or SOS location, see [Marking a Man Overboard or Other SOS Location, page 58](#).

Position Tracking

You can connect a VHF radio to the same NMEA 2000® network as the chartplotter to send position reports and track vessels that send position reports. The vessel must send the correct PGN data (PGN 129808; DSC Call Information) to use this feature.

You can connect the chartplotter to a VHF radio using NMEA® 0183, to send position reports and track vessels that send position reports.

Every position report call received is logged in the DSC list ([DSC List, page 132](#)).

Viewing a Position Report

- 1 From a chart or 3D chart view, select **☰** > **Layers** > **Other Vessels** > **DSC** > **DSC List**.

TIP: You can quickly access the DSC list from the messages and warnings menu ([Messages and Warnings, page 168](#)).

- 2 Select a position-report call.
- 3 Select **Review**.
- 4 Select an option:
 - To view the position report details, select **➤**.
 - To view to a chart marking the location, select **◀**.

Navigating to a Tracked Vessel

- 1 From a chart or 3D chart view, select **☰** > **Layers** > **Other Vessels** > **DSC** > **DSC List**.

TIP: You can quickly access the DSC list from the messages and warnings menu ([Messages and Warnings, page 168](#)).

- 2 Select a position-report call.
- 3 Select **Review** > **Navigate To**.
- 4 Select **Go To** or **Route To**.

Creating a Waypoint at the Position of a Tracked Vessel

- 1 From a chart or 3D chart view, select **☰** > **Layers** > **Other Vessels** > **DSC** > **DSC List**.

TIP: You can quickly access the DSC list from the messages and warnings menu ([Messages and Warnings, page 168](#)).

- 2 Select a position-report call.
- 3 Select **Review** > **Create Waypoint**.

Editing Information in a Position Report

- 1 From a chart or 3D chart view, select **☰** > **Layers** > **Other Vessels** > **DSC** > **DSC List**.

TIP: You can quickly access the DSC list from the messages and warnings menu ([Messages and Warnings, page 168](#)).

- 2 Select a position-report call.
- 3 Select **Review** > **Edit**.
 - To enter the name of the vessel, select **Name**.
 - To select a new symbol, select **Symbol**, if available.

- To enter a comment, select **Comment**.
- To show a trail line for the vessel if your radio is tracking the position of the vessel, select **Trail**.
- To select a color for the trail line, select **Trail Line**.

Deleting a Position-Report Call

- 1 From a chart or 3D chart view, select **••• > Layers > Other Vessels > DSC > DSC List**.

TIP: You can quickly access the DSC list from the messages and warnings menu (*Messages and Warnings*, page 168).

- 2 Select a position-report call.
- 3 Select **Review > Edit > Clear Report**.

Viewing Vessel Trails on the Chart

You can view trails for all tracked vessels on some chart views. By default, a black line indicates the path of the vessel, a black dot indicates each previously reported position of a tracked vessel, and a blue flag indicates the last reported position of the vessel.

- 1 From a chart or 3D chart view, select **Options > Layers > Other Vessels > DSC > DSC Trails**.
- 2 Select the number of hours to show tracked vessels on the chart.
For example, if you select 4 Hours, all trail points that are less than four hours old appear for all tracked vessels.

Individual Routine Calls

When you connect the chartplotter to a Garmin® VHF radio, you can use the chartplotter interface to set up an individual routine call.

When setting up an individual routine call from your chartplotter, you can select the DSC channel on which you want to communicate. The radio transmits this request with your call.

Selecting a DSC Channel

NOTE: The selection of a DSC channel is limited to those channels that are available in all frequency bands. The default channel is 72. If you select a different channel, the chartplotter uses that channel for subsequent calls until you call using another channel.

- 1 From a chart or 3D chart view, select **••• > Layers > Other Vessels > DSC > DSC List**.
TIP: You can quickly access the DSC list from the messages and warnings menu (*Messages and Warnings*, page 168).
- 2 Select a vessel or a station to call.
- 3 Select **Review > Call with Radio > Channel**.
- 4 Select an available channel.

Making an Individual Routine Call

NOTE: When initiating a call from the chartplotter, if the radio does not have an MMSI number programmed, the radio will not receive call information.

- 1 From a chart or 3D chart view, select **••• > Layers > Other Vessels > DSC > DSC List**.
TIP: You can quickly access the DSC list from the messages and warnings menu (*Messages and Warnings*, page 168).
- 2 Select a vessel or a station to call.
- 3 Select **Review > Call with Radio**.
- 4 If necessary, select **Channel**, and select a new channel.
- 5 Select **Send**.
The chartplotter sends information about the call to the radio.
- 6 On your Garmin® VHF radio, complete the call.

Making an Individual Routine Call to an AIS Target

- 1 From a chart or 3D chart view, select an AIS target.
- 2 Select **AIS Vessel > Call with Radio**.
- 3 If necessary, select **Channel**, and select a new channel.
- 4 Select **Send**.
The chartplotter sends information about the call to the radio.

5 On your Garmin® VHF radio, complete the call.

Gauges and Graphs

The gauges and graphs provide various information about the engine and environment. To view the information, a compatible transducer or sensor must be connected to the network.

Viewing the Gauges

- 1 Select **Gauges**.
- 2 Select a gauge, such as **Vessel**.



- 3 Select **<** or **>** to view a different gauge page, if applicable.

Engine Alert Icons

If an icon lights up on the gauges page, it indicates an issue with the motor.

	Low oil level or oil pressure alert
	Temperature alert
	Battery voltage alert
	Check engine alert

Changing the Data Shown in a Gauge

- 1 Open a gauge page.
- 2 Select **Options > Edit Gauge Pages**.
- 3 Select a gauge to edit.
TIP: You can hold any gauge to quickly change the data.
- 4 Select **Replace Data**.
- 5 Select a data type.
- 6 Select the data to display.

Customizing the Gauges

You can add a gauge page, change the layout of the gauge page, change how the gauges are displayed, and change the data in each gauge.

- 1 Open a gauge page.

- 2 Select **Options > Edit Gauge Pages**.
- 3 If necessary, select a gauge view or gauge to edit.
- 4 Select an option:
 - To change the data shown in a gauge, select the gauge and select **Replace Data**.
 - To change the layout of the gauges on the page, select **Change Layout**.
 - To add a page to this set of gauge pages, select **Add Page**.
 - To remove a page from this set of gauge pages, select **Remove Page**.
 - To change the order of this page in the set of gauge pages, select **Move Page Left** or **Move Page Right**.
 - To restore this page to the original view, select **Restore Default View**.

Customizing Engine Gauge and Fuel Gauge Limits

You can configure the upper and lower limits and the range of desired standard operation of a gauge.

NOTE: Not all options are available for all gauges.

- 1 From an applicable gauges screen, select **Options > Installation > Set Gauge Limits**.
- 2 Select a gauge to customize.
- 3 Select an option:
 - To set the minimum value of the standard operating range, select **Rated Min..**
 - To set the maximum value of the standard operating range, select **Rated Max..**
 - To set the lower limit of the gauge lower than the rated minimum, select **Scale Min..**
 - To set the upper limit of the gauge higher than the rated maximum, select **Scale Max..**
- 4 Select the limit value.
- 5 Repeat steps 4 and 5 to set additional gauge limits.

Selecting the Number of Engines Shown in Gauges

You can show information for up to four engines.

- 1 From the engine gauges screen, select **Options > Installation > Engine Selection > Num. Engines**.
- 2 Select an option:
 - Select the number of engines.
 - Select **Auto Configure** to automatically detect the number of engines.

Customizing the Engines Shown in Gauges

Before you can customize how the engines are shown in the gauges, you must manually select the number of engines ([Selecting the Number of Engines Shown in Gauges, page 137](#)).

- 1 From the engine gauges screen, select **Options > Installation > Engine Selection > Num. Engines**.
- 2 Select **First Engine**.
- 3 Select the engine to display in the first gauge.
- 4 Repeat for the remaining engine bars.

Enabling Status Alarms for Engine Gauges

You can enable the chartplotter to display engine status alarms.

From the engine gauges screen, select **Options > Installation > Status Alarms > On**.

When an engine alarm is triggered, a gauge status alarm message appears and the gauge may become red depending on the type of alarm.

Enabling Some Engine Gauge Status Alarms

- 1 From the engine gauges screen, select **Options > Installation > Status Alarms > Custom**.
- 2 Select one or more engine gauge alarms to turn on or off.

Yamaha® Engine and Motor Gauges

For the best experience monitoring and controlling your compatible Yamaha engine or motor using this chartplotter, you must connect your engine or motor to the chartplotter using the appropriate interface adapter. If needed, contact your Yamaha dealer for more information.

Select **Gauges > YAMAHA** to view the Yamaha engine gauges.

This image is only one example of how this screen may appear based on the number and types of engines or motors connected to the engine network and throttle controller. Consult the owner's manual provided with your Yamaha engine, motor, or display for complete information.

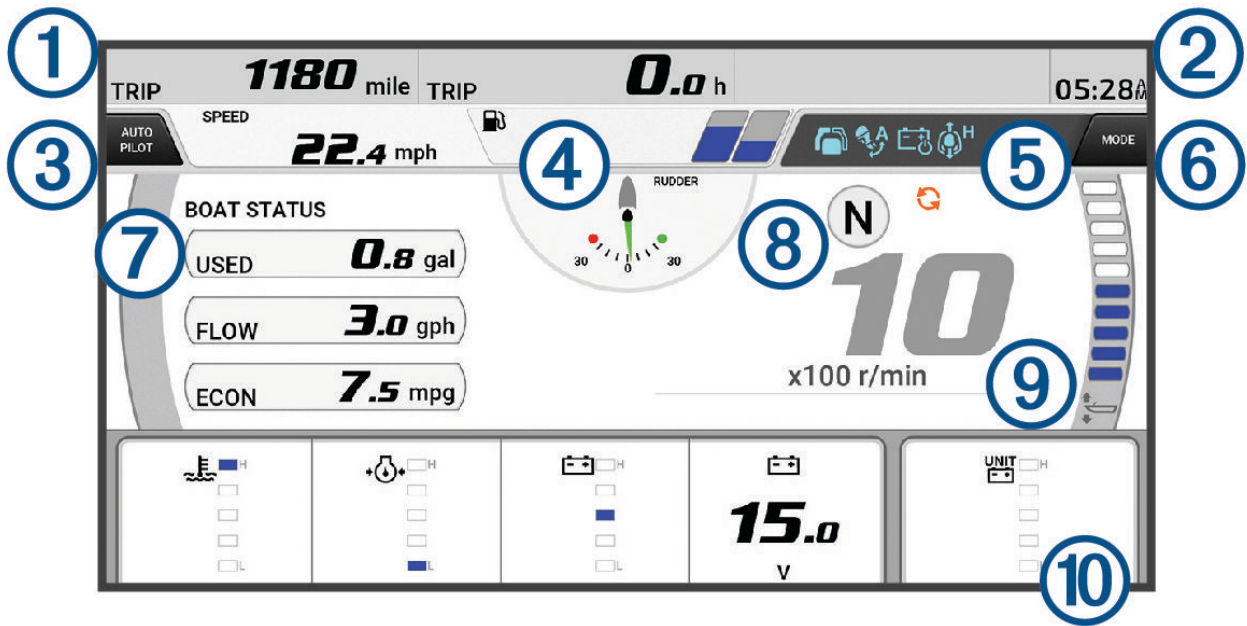



①	Boat data fields Hold to replace the data.
②	Current time Hold to view trip data.
③	Select to toggle the autopilot bar on and off (Helm Master® EX). Select to set the joystick button for Set Point functions (Helm Master and Helm Master EX).
④	Tank level information or battery level information Hold a tank or a battery to view detailed tank level sensor or battery level information.
⑤	Status icons: <ul style="list-style-type: none"> • Blue: engine or motor function indicators • Orange: engine or motor status or condition information • Red: engine or motor warning and alert information GPS signal strength (Helm Master)
⑥	Select to set the Fish Point settings (Helm Master/Helm Master EX). Select to set the trolling speed (Helm Master/Helm Master EX/Mechanical RC/Digital Electronic RC (6X6/6X7)).
⑦	Boat data fields Hold to replace the data.
⑧	Shift position indicator Engine RPM
⑨	Tachometer and trim angle Hold to change the background.
⑩	Engine, motor, and boat data fields Hold to replace the data and change the gauge appearance.

Engine and Motor Function Icons





Blue icons indicate the status of engine or motor functions.

	The autopilot is active.
	Speed control is active.
	Single lever control is active.
	Trim assist is active.
	The Battery Management System (BMS) is active.

	Joystick hold is active.
	Wave assist is active.

Engine and Motor Status Icons

Orange icons indicate engine or motor status conditions.









	Yamaha® security system is on.
	Engines are under synchronization control.
	Engines are warming up.
	The engine or motor output is limited.
	The Battery Management System (BMS) is off.

Engine and Motor Warning Icons

Red icons indicate engine or motor abnormalities.

NOTICE

Consult your Yamaha® dealer if the problem cannot be located and corrected.

	Low cooling water pressure.
	Low oil pressure. Stop the engine. Check the engine oil level, and add more oil if necessary.
NOTICE	
Do not continue to run the engine if this indicator is on. Serious engine damage will occur.	
	Engine overheating. Stop the engine immediately. Check the cooling water inlet, and clear it if it is blocked.
NOTICE	
Do not continue to run the engine if this indicator is on. Serious engine damage will occur.	
	Low battery voltage. Check the battery and battery connections, and tighten all loose battery connections. Return to port soon if tightening the battery connections does not increase the battery voltage. Consult your Yamaha dealer immediately. Do NOT stop the engine when this alert is on. If you do, you may not be able to restart the engine.
	Water in the fuel. Water has collected in the fuel filter (fuel separator). Stop the engine immediately and consult the engine manual to drain the water from the fuel filter. Gasoline mixed with water might cause damage to the engine.
	Check engine/maintenance alert. There is an issue with the combustion engine. Consult your Yamaha dealer immediately. The check engine alert also appears when more than 100 hours have elapsed since the previous maintenance.
	Check motor/maintenance alert. There is an issue with the electric motor. Consult your Yamaha dealer immediately.
	Engine alert notification. (Helm Master®)
	Engine emission issue.

Setting Up the Gauges

Configuring the Number of Engines

- 1 From a gauges screen, select **Options > Num. Engines**.
- 2 Select the number of engines.

Configuring the Tank Level Sensors

- 1 From a gauges screen, select **Options > Tank Preset**.
- 2 Select a tank level sensor to configure.
- 3 Select **Name**, enter a name, and select **Done**.

- 4 Select **Type**, and select the type of sensor.
- 5 Select **Style**, and select the style of sensor.
- 6 Select **Tank Capacity**, enter the capacity of the tank, and select **Done**.
- 7 Select **Calibration**, and follow the on-screen instructions to calibrate the tank levels.
If you do not calibrate the tank levels, the system uses default settings for the tank levels.

Changing the Data Shown

- 1 From a data screen, hold a customizable item.
- 2 Select a data type.
- 3 Select the data to display.

Yamaha® Engine Data Settings

NOTICE

Be sure the settings are set correctly. If not, the engine screen will not display the correct information.

From a Yamaha engine screen, select Options.

Trip: Displays information about the trip, such as distance and hours, and allows you to reset these values.

Maintenance Reminder: Displays maintenance information, enables you to set the maintenance intervals, and allows you to reset the time elapsed since the previous maintenance.

Tank Preset: Sets the tank name, fluid type, sensor style, and tank capacity, and calibrates the sensor.

Trim Assist: Turns the trim assist feature on or off. Available on the Helm Master® system equipped with a digital engine control (DEC) system.

Steer Friction: Sets the friction on the steering wheel. The friction adjusts automatically according to the engine speed. Available on the Helm Master system equipped with a digital engine control (DEC) system.

Lock to Lock: Sets the number of times the steering wheel can be turned between locks, fully to port and fully to starboard.

Speed Control: Sets the speed source to GPS or RPM. Using GPS as the Speed Source is available only with the Helm Master EX system equipped with an autopilot or joystick. GPS is not available on the Helm Master system.

Speed Control > Wave Assist: Turns on the Wave Assist feature for applicable systems.

Speed Control > Wave Assist Level: Sets the sensitivity level for the Wave Assist feature. The higher you set the level, the more the system reacts to wave height and distances when adjusting the speed automatically.

Autopilot Setting: Configures the Yamaha autopilot settings. Available on the Helm Master EX system equipped with an autopilot. For Garmin® autopilot information, see ([Autopilot, page 118](#)).

Joystick and Set Point: Sets the joystick thrust, trim angle and preset, fine tuning distance, and fish point settings. Available on the Helm Master system and the Helm Master EX system equipped with a joystick.

Trim Assist Preset: Sets up the trim assist presets. Available on the Helm Master system equipped with a digital engine control (DEC) system.

Fuel Flow Offset: Sets the offset for the fuel flow data.

Off Timer: Turns off the system one hour after the engine is turned off.

Battery Management: Configures the battery management system, such as setting the type and capacity of the batteries. Also displays the battery status. Available on Helm Master EX systems equipped with Battery Management System (BMS).

Calibration: Calibrates various features, such as the Trim Zero Set and compass.

Reset: Resets the engine and gateway data.

Mercury® Engine Gauges

NOTE: This feature is available only when connected to the Mercury SmartCraft Connect gateway. The available data varies based on the engine network and may include RPM, engine hours, coolant pressure, oil pressure, and other data.

Select **Gauges > Mercury** to view the Mercury engine gauges.

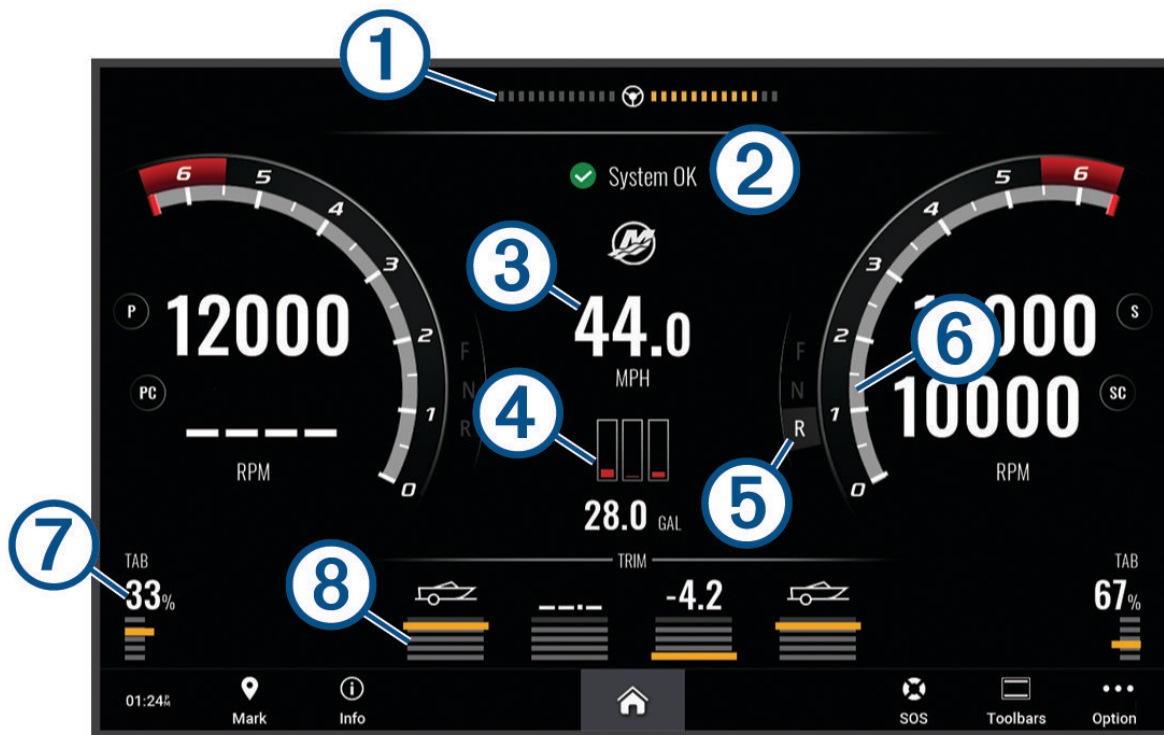

①	Engine voltage or Mercury Steering Angle ²
②	Boat status
③	Boat speed
④	Fuel
⑤	Transmission gear
⑥	Engine speed
⑦	Trim tabs
⑧	Engine trim

TIP: To view additional engine details, select **Options > Engine Data**.

Setting the Fuel Alarm

⚠ CAUTION

The Beeper setting must be turned on to make alarms audible (*Sounds and Display Settings, page 200*). Failure to set audible alarms could lead to injury or property damage.

Before you can set a fuel level alarm, you must connect a compatible fuel flow sensor to the chartplotter. You can set an alarm to sound when the total amount of remaining onboard fuel reaches the level you specify.

- 1 Select **⚙ > Alarms > Fuel > Total Fuel Onboard > On**.
- 2 Enter the remaining amount of fuel that triggers the alarm, and select **Done**.

Synchronizing the Fuel Data with the Actual Vessel Fuel

If you are using fuel flow sensors, you must synchronize the fuel levels in the chartplotter with the actual fuel in the vessel when you add fuel to your vessel. If you are using fuel tank sensors, the level is adjusted automatically based on the tank level sensor data and it is not necessary to synchronize fuel levels manually (*Fuel Settings, page 208*).

² The Mercury Steering Angle may appear on the display, depending on the engine model and configuration, and its location on the display may vary.

- 1 Select **Gauges**.
- 2 Select **Engines** or **Fuel**.
- 3 Select **Options**.
- 4 Select an option:
 - If you have filled up all the fuel tanks on the vessel, select **Fill Up All Tanks**. The fuel level is set to maximum capacity.
 - If you have added less than a full tank of fuel, select **Add Fuel to Boat**, and enter the amount added.
 - To specify the total fuel in the vessel tanks, select **Set Total Fuel Onboard**, and enter the total amount of fuel in the tanks.

Viewing the Wind Gauges

Before you can view wind information, you must have a wind sensor connected to the chartplotter.

Select **Gauges > Wind**.

Configuring the Sailing Wind Gauge

You can configure the sailing wind gauge to show true or apparent wind speed and angle.

- 1 From the wind gauge, select **Options > Edit Gauge Pages**.
- 2 In the window on the left, select the **Sailing Wind Gauge**.
- 3 Select an option:
 - To show true or apparent wind angle, select **Needle**, and select an option.
 - To show true or apparent wind speed, select **Wind Speed**, and select an option.

Configuring the Speed Source

You can specify whether the vessel speed data displayed on the gauge and used for wind calculations is based on water speed or GPS speed.

- 1 From the wind gauge, select **Options > Edit Gauge Pages**.
- 2 In the window on the left, select **Compass Gauge**.
- 3 Select **Speed Display**, and select an option:
 - To calculate the vessel speed based on data from the water-speed sensor, select **Water**.
 - To calculate the vessel speed based on GPS data, select **Satellite Positioning**.

Configuring the Heading Source of the Wind Gauge

You can specify the source of the heading displayed on the wind gauge. Magnetic heading is the heading data received from a heading sensor, and GPS heading is calculated by your chartplotter GPS (course over ground).

- 1 From the wind gauge, select **Options > Edit Gauge Pages**.
- 2 In the window on the left, select **Compass Gauge**.
- 3 Select **Heading Source**, and select an option:
 - To use heading data received from a heading sensor, select **Magnetic**.
 - To use heading data calculated using GPS, select **GPS**.

When moving at low speeds or when stationary, the magnetic compass source is more accurate than the GPS source.

Customizing the Close-Hauled Wind Gauge

You can specify the range of the close-hauled wind gauge for both the upwind scale and the downwind scale.

- 1 From the wind gauge, select **Options > Edit Gauge Pages**.
- 2 In the window on the left, select **Compass Gauge** or **Sailing Wind Gauge**.
- 3 Select **Replace Data > Sailing > Close Hauled Gauge**.
The Compass Gauge or Sailing Wind Gauge is replaced by the Close Hauled Gauge.
- 4 Select an option:
 - To set the maximum and minimum values that appear when the upwind close-hauled wind gauge appears, select **Change Upwind Scale**, and set the angles.
 - To set the maximum and minimum values that appear when the downwind close-hauled wind gauge appears, select **Change Downwind Scale**, and set the angles.
 - To view true or apparent wind, select **Wind**, and select an option.

Viewing Trip Gauges

Trip gauges show information for odometer, speed, time, and fuel for your present trip.

Select **Gauges > Trip**.

Resetting Trip Gauges

- 1 Select **Options**.
- 2 Select an option:
 - To set all the readings for the present trip to zero, select **Reset Trip**.
 - To set the maximum speed reading to zero, select **Reset Maximum Speed**.
 - To set the odometer reading to zero, select **Reset Odometer**.
 - To set all the readings to zero, select **Reset All**.

Viewing Graphs

Before you can view graphs of various environmental changes, such as temperature, depth, and wind, you must have an appropriate transducer or sensor connected to the network.

You can view graphs of sensor data by creating a new Combo page or by adding a graph to an existing Combo page.

- 1 Create a new **Combo** page or open an existing **Combo** page ([Creating a New Combination Page, page 24](#)).
- 2 Select the window where you want to add a graph, and select **Graphs**.
- 3 Select the graph you want to add.

TIP: You can change the graph in an active combo window by selecting **••• > Change Graph**, and selecting a new graph.

Setting the Graph Range and Time Scales

You can indicate the amount of time and the range of sensor data that appears in the depth, wind, and water temperature graphs.

- 1 Select a graph in a **Combo** page, and select **•••**.
- 2 Select an option:
 - To set a time-elapsed scale, select **Duration**. The default setting is 10 minutes. Increasing the time-elapsed scale allows you to view variations over a longer period of time. Decreasing the time-elapsed scale allows you to view more detail over a shorter period of time.
 - To set the graph scale, select **Scale**. Increasing the scale allows you to view more variation in readings. Decreasing the scale allows you to view more detail in the variation.

Disabling Graph Filtering

The wind speed and wind angle graph filtering smooths out sensor data before it is displayed on a graph. The default setting is On. You can disable the filtering.

- 1 Select a graph in a **Combo** page, and select **•••**.
- 2 Select **Filter > Off**.

Garmin OnBoard™ Man Overboard Engine Cutoff System

⚠ CAUTION

For the best possible performance and to avoid potential injury, damage to the device, or damage to your vessel, installation by a qualified marine installer is recommended.

NOTICE

The following instructions apply to the Garmin OnBoard system only. If you have a Yamaha® vessel with a Wireless Station and MOB tags, refer to the instructions provided with your Yamaha Wireless Station manual when using and configuring your Yamaha MOB tags.

If you have installed a Garmin OnBoard man overboard Engine Cutoff System (ECOS) on your boat, you can use the chartplotter to interact with and customize the system.

You must install and test the Garmin OnBoard engine cutoff system before using it on your vessel. Follow the *Garmin OnBoard Engine Cutoff System Installation Instructions* provided in the product box to install and test the system.

MOB Tag

⚠ CAUTION

Users should wear the MOB tag in a location that would likely be submerged during a man overboard event, such as on the wrist, belt, or lower part of a life jacket. The system may not activate as expected if the MOB tag is worn in a different location that may not become submerged, such as on the shoulder.



One MOB tag must be worn by the captain when piloting the vessel. Additional tags may be purchased and assigned as additional Captain tags or as Passenger tags. These roles determine the behavior of the system when a tag is out of range.

NOTE: You can connect up to eight total tags to the Garmin OnBoard™ engine cutoff system, and at least one tag must be assigned the Captain role.

①	<p>Power and interface button:</p> <ul style="list-style-type: none">• If the tag is not connected to the Garmin OnBoard system, hold for two seconds to turn the tag on and off.• If the tag is connected to the Garmin OnBoard system:<ul style="list-style-type: none">• Hold for 2 seconds or longer to change the tag status from protected to disarmed and back to protected.• Press to show the status and battery level. The shield and battery icon LEDs flash different colors (Checking the Status of an MOB Tag, page 146).• Hold for four seconds or longer to turn the tag on and off.
②	<p>MOB button:</p> <p>Press to initiate a Man Overboard (MOB) function (Initiating an MOB Procedure from an MOB Tag Manually, page 147).</p> <p>On a tag with the Captain role, you can hold this for two seconds or longer to initiate a MOB function that also kills the engine or engines.</p>
🛡	<p>Status indicator. When you press the power button, the LED color indicates the status of the tag (Checking the Status of an MOB Tag, page 146).</p>
🔋	<p>Battery-level indicator. When you press the power button, the LED color indicates the battery status of the tag (Checking the Status of an MOB Tag, page 146).</p>

Attaching the Band or Carabiner Loop

The MOB tag is packaged with a carabiner loop, a wristband, and a floating keytag. You can use the carabiner loop to attach the MOB tag to your clothing, or you can attach the MOB tag to the wristband to wear it on your wrist. You can also attach the floating keytag to the carabiner or to the wristband to prevent the MOB tag from sinking if it is accidentally lost in the water. Follow these steps to attach the wristband or the carabiner loop to the MOB tag.

- 1 Insert one end of the spring bar on the band or carabiner loop into one of the holes on the MOB tag.

- 2 Slide the quick-release pin to retract the other end of the spring pin.
- 3 Align the spring bar with the other hole in the MOB tag, and release the pin.



MOB Tag Roles

You can connect multiple MOB tags to the Garmin OnBoard™ engine cutoff system and assign different roles to the tags, depending on who is wearing it. For details on the exact actions performed by each role, see ([MOB Tag Behavior, page 145](#)).

Captain: This role is intended for an MOB tag worn by a vessel captain or an individual responsible for controlling the vessel. A tag with a Captain role allows the system to shut off the engine or engines during a Man Overboard (MOB) event.

NOTICE

At least one MOB tag with the Captain role assigned must be paired for the Garmin OnBoard engine cutoff system to function. You cannot change the role of a Captain tag if it is the only tag paired with the Captain role assigned.

Passenger: This role is intended for an MOB tag worn by a passenger on the vessel. A tag with a Passenger role allows the system to create alerts during a MOB event, but it does not allow the system to shut off the engines.

⚠ CAUTION

When a tag with a Passenger role disconnects, the system does not shut off the engines. The system shuts off the engines only when all Captain tags are disconnected.

MOB Tag Behavior

When a protected MOB tag disconnects from the Garmin OnBoard™ engine cutoff system by traveling out of range of the GOS™ 10 hub, the Garmin OnBoard system considers this to be a man-overboard event. Based on the role assigned to the tag, the performs these actions in this general order.

Action	Captain Role	Passenger Role
A message banner appears on all connected chartplotters indicating that the connection with the tag has been lost. The alarm buzzer connected to the GOS 10 hub sounds a loud alert.	✓	✓
A three-second countdown timer appears on all connected chartplotters. NOTE: You can cancel the timer and alert if the man-overboard event was an error. If the countdown timer is not canceled, after three seconds, the system: <ul style="list-style-type: none"> • cuts off power to the engines to stop the vessel • creates a Man Overboard (MOB) waypoint on the chartplotter at the location where the signal from the MOB tag was lost • displays a message stating Engine Cutoff Initiated 	✓	✗
NOTICE		
If more than one MOB tag connected to the system are assigned the Captain role, all of the Captain tags must disconnect before the system kills the engines and triggers an MOB action.		
A fifteen-second countdown timer appears on all connected chartplotters. NOTE: You can cancel the timer and alert if the man-overboard event was an error. If the countdown timer is not canceled, after fifteen seconds the system creates a Man Overboard (MOB) waypoint on the chartplotter at the location where the signal was lost. The engines remain functional.	✗	✓
⚠ CAUTION		
When a tag with a Passenger role disconnects, the system does not shut off the engines. The system shuts off the engines only when all Captain tags are disconnected.		





Action	Captain Role	Passenger Role
You are prompted to begin navigation to the MOB waypoint. If a compatible autopilot system is connected to the network, you can initiate a route to the waypoint from this message.		
NOTICE	✓	✓
For an MOB tag with a Captain role, you must acknowledge the Engine Cutoff Initiated message on a chartplotter before power is restored to the engines and you can begin navigating again.		
An SOS script appears that can be used to make a VHF distress call. From this view, you can also see the location of the MOB waypoint on the chart and dismiss it if necessary.		
⚠ CAUTION	✓	✓
The Garmin OnBoard system does not contact emergency services at any time. You must initiate a distress call if needed.		

Turning an MOB Tag On and Off

When you are not using the tag, you can turn it off to preserve battery life.

NOTICE



You must turn on an MOB tag before it can communicate with the GOS™ 10 hub.



- 1 If the MOB tag is off, hold the power button on the side of the tag for at least two seconds.
The  and  icons flash green twice to indicate that the MOB tag is now on.
- 2 If the MOB tag is on, hold the power button on the side of the tag for at least 4 seconds.
The  and  icons flash red twice to indicate that the MOB tag is now off.

Checking the Status of an MOB Tag

Press and release the power button on the side of the MOB tag.

NOTE: You should not hold the power button when checking the status of the tag, as this turns off the tag. Only press and release it to view status information.

The  and  icons blink a color to indicate the status of the tag.

	Green	Connected and protected
	Yellow	Connected, not protected
	Red	Not connected
	White flash	Appears after the status color to indicate that the tag is assigned a Captain role.
	Green	The battery is full or mostly full
	Yellow	The battery is getting low and should be replaced soon
	Red	The battery is critically low and should be replaced immediately

Disarming an MOB Tag

By default, when you turn on an MOB tag within range of the GOS™ 10 hub, it connects to the system in a protected status. When a tag is in a protected status, it triggers an action based on its assigned role when it loses communication with the GOS 10 hub.

On occasion, you may want to leave the vessel or otherwise keep a connected tag from triggering an event. To do this, you can disarm a tag. A disarmed tag remains connected to the GOS 10 hub when in range, but it does not trigger an action when it travels out of range or otherwise becomes disconnected.

By default, when you disarm an MOB tag, the system will attempt to protect it again after 15 minutes. If the tag is out-of-range of the GOS 10 hub when this time elapses, it becomes protected the next time it connects. You cannot change this default reacquisition time, although you can adjust an individual instance after you have disarmed a tag ([Changing the Reacquisition Time for an MOB Tag, page 149](#)).

- 1 If necessary, turn on the MOB tag you want to change.
- 2 Hold the power button on the side of the MOB tag for two seconds.
 flashes yellow to indicate that the MOB tag is disarmed.
- 3 To change the status of a tag to protected again, you can repeat the previous step.

♥ flashes green to indicate that the MOB tag is protected again.

TIP: You can also disarm connected MOB tags using the chartplotter ([Configuration, page 147](#)).

Initiating an MOB Procedure from an MOB Tag Manually

If a passenger falls overboard who is not wearing an MOB tag, or if you want to initiate a Man Overboard (MOB) procedure without waiting for a tag to become out of range of the GOS™ 10 hub, you can manually trigger the effect directly from any MOB tag connected to the Garmin OnBoard™ engine cutoff system.

Press the large MOB button on the face of a connected MOB tag.

On a tag with the Captain role, you can hold the MOB button for at least two seconds to initiate a MOB function that also kills the engine or engines.

The Garmin OnBoard system creates a Man Overboard (MOB) waypoint on the chartplotter at the location where the button was pressed and prompts you begin navigating to the waypoint. An SOS script appears that can be used to make a VHF distress call, and you see the location of the MOB waypoint on the chart and dismiss it if necessary.

Replacing the MOB Tag Battery

⚠ WARNING

See the *Important Safety and Product Information* guide in the product box for product warnings and other important information.

NOTICE

The MOB tag uses a CR2032 3V coin-cell battery. You must install a new CR2032 3V coin-cell battery as a replacement. Using any other type of battery is not supported.

You should purchase a replacement battery only from a high-quality manufacturer and a reputable vendor. Using a low-quality battery could result in poor product performance and reduced battery life, especially at low temperatures. Do not use rechargeable batteries. Rechargeable batteries may have a higher voltage specification and can cause permanent damage to the device.

- 1 Using a #1 Phillips screwdriver, loosen the four captive screws to remove the back cover.
- 2 Gently lift the white tab to release the battery from the back cover.
- 3 Place the new battery in the back cover, with the positive (+) side down.
- 4 Make sure the rubber gasket in the front cover of the MOB tag is not broken and is fully seated in its groove.

The gasket fits in the groove in a specific orientation.

NOTICE

If the gasket is not properly and fully seated in the groove, it does not create a seal, which leads to the failure of the MOB tag when it is exposed to water. Contact Garmin® product support for information on purchasing a replacement gasket.

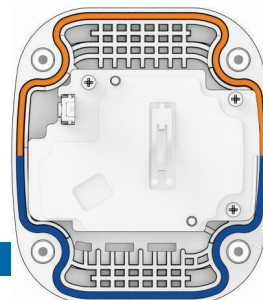

After you replace the battery, you may need to pair the MOB tag again ([Pairing an MOB Tag, page 148](#)).

Configuration

To configure the Garmin OnBoard™ engine cutoff system and MOB tags, on a connected chartplotter select ⚙ > **Communications > Wireless Devices > OnBoard MOB System > MOB Tags**, then select the name of a tag if necessary.

Role: Changes the role of an MOB tag.

NOTE: The Garmin OnBoard engine cutoff system must have at least one paired tag with the Captain role assigned. To change the role of an existing tag from Captain to Passenger, there must be more than one paired tag with the Captain role.

Rename: Changes the name assigned to a tag for easier identification. Changing the name does not change the role.

Review: Shows the status and other information about a tag.

Review > Remove Device: Unpairs and removes a tag from the Garmin OnBoard engine cutoff system.

Turn Off: Turns off a tag.

Protect: Changes the protection status of a tag. Protected tags trigger actions when leaving range of the hub, disarmed tags do not trigger actions. Tags are protected by default, and can be disarmed for a set period of time before automatically becoming protected again ([Disarming an MOB Tag, page 146](#)).

Reacquire In: Available only when a tag is disarmed. Temporarily changes the time for when a disarmed tag automatically becomes protected again. If the tag is out-of-range when this time elapses, it will become protected again as soon as it is in range and connects to the hub.

New Connection: Begins the pairing process on the hub to connect a new MOB tag.

Adding the MOB Tags Overlay

When connected to a GOS™ 10 hub, you can add an overlay on the chartplotter to control MOB tag functions.

1 From the page where you want to add the overlay, select **Options > Edit Overlays**.

TIP: You can also select Toolbars from the menu bar to quickly change the overlays.



2 Select **Top Bar, Bottom Bar, Left Bar, or Right Bar**.

3 Select **MOB Tags > Back**.

MOB Tags Overlay

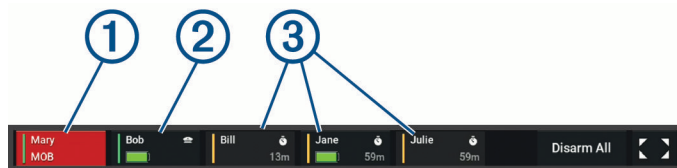
When connected to a GOS™ 10 hub, you can add an overlay on the chartplotter to control MOB tag functions.



①	Protected Passenger tag in Man Overboard (MOB) status: <ul style="list-style-type: none"> The green line on the left indicates that the tag is protected. The red shading and "MOB" text indicates that the tag has left the range of the hub and is now in an active MOB status (<i>MOB Tag Behavior, page 145</i>).
②	Protected Captain tag: <ul style="list-style-type: none"> The green line on the left indicates that the tag is protected.  indicates that this is a captain tag.
③	Disarmed Passenger tags: <ul style="list-style-type: none"> The yellow line on the left indicates that the tag is disarmed. The  and time indicate when the system will attempt to protect the tag again automatically.
Disarm All	Sets all connected tags to the Disarmed status.
	Opens the full-screen MOB tag page.

Pairing an MOB Tag

When you purchase a Garmin OnBoard™ engine cutoff system, the MOB tag packaged with the system is already paired with the GOS™ 10 hub and is ready to use. If you purchase additional tags you must pair them with the GOS 10 hub.

1 If necessary, turn on the Garmin® devices on the vessel, including the GOS 10 hub and any connected chartplotters.

2 Hold the power button on the side of the MOB tag for more than two seconds to turn it on.

 on the MOB tag flashes red to indicate that the tag is not connected to the GOS 10 hub.

3 On a connected chartplotter, select  > **Communications > Wireless Devices > OnBoard MOB System > MOB Tags > New Connection**.

TIP: If it is accessible, you can press the button on the GOS 10 hub three times to start the pairing process. The LED on the GOS 10 hub flashes blue to indicate that it is in pairing mode.

4 On the MOB tag, press the power button on the side three times.

 on the MOB tag flashes blue to indicate that it is in pairing mode.

A message is shown on the connected chartplotter screen, indicating a pairing request from the MOB tag to the GOS 10 hub.

5 On the connected chartplotter, confirm the pairing request to complete the pairing process.

If this is the first MOB tag to be paired with the GOS 10 hub, it is assigned the Captain role by default. All additional MOB tags paired to the GOS 10 hub are assigned the Passenger role by default.

Changing the Role of an MOB Tag

NOTE: At least one MOB tag with the Captain role assigned must be paired for the Garmin OnBoard™ engine cutoff system to function. You cannot change the role of a Captain tag if it is the only tag paired with the Captain role assigned.

- 1 On a connected chartplotter, select  > **Communications** > **Wireless Devices** > **OnBoard MOB System** > **MOB Tags**.
- 2 Select the MOB tag you want to change.
- 3 Select **Role**.
- 4 Select the role you want to assign to the MOB tag.

Changing the Name of an MOB Tag

- 1 On a connected chartplotter, select  > **Communications** > **Wireless Devices** > **OnBoard MOB System** > **MOB Tags**.
- 2 Select the MOB tag you want to change.
- 3 Select **Rename**.
- 4 Enter a new name for the MOB tag.

Changing the Reacquisition Time for an MOB Tag

By default, when you disarm an MOB tag, the system attempts to protect it again after 15 minutes. You can temporarily extend the length of time before a disarmed tag becomes protected again automatically. After the disarmed tag becomes protected again, this value resets to the default of 15 minutes for the next time you disarm the tag.

- 1 Disarm an MOB tag.
- 2 On a connected chartplotter, select  > **Communications** > **Wireless Devices** > **OnBoard MOB System** > **MOB Tags**.
- 3 Select the disarmed MOB tag.
- 4 Select **Reacquire In**.
- 5 Select a new value.

The system attempts to protect the disarmed MOB tag again after the newly-specified value elapses. After the disarmed tag becomes protected again, this value resets to the default of 15 minutes for the next time you disarm this tag.

Removing an MOB Tag

If you no longer want to use a paired MOB tag, you can remove it from the system.

NOTE: At least one MOB tag with the Captain role assigned must be paired for the Garmin OnBoard™ engine cutoff system to function. You cannot remove a tag if it is the only tag paired with the Captain role assigned.

- 1 On a connected chartplotter, select  > **Communications** > **Wireless Devices** > **OnBoard MOB System** > **MOB Tags**.
- 2 Select the MOB tag you want to remove.
- 3 Select **Review** > **Remove Device**.

Restoring the Garmin OnBoard™ Engine Cutoff System to Factory Default Settings

NOTICE

When performing a factory reset on the Garmin OnBoard engine cutoff system, the security event log stored on the GOS™ 10 hub is cleared. All personal information, including locations and timestamps, as well as security-event records are deleted.

- 1 Turn on the GOS 10 hub.
- 2 Press the button on the GOS 10 hub five times.

NOTE: Restoring the GOS 10 hub software to factory defaults does not affect any paired MOB tags. Any previously-paired MOB tags retain custom name and role information you may have applied, but are no longer paired to the GOS 10 hub. Each previously-paired MOB tag must be reset individually if you want to clear custom name or role configuration information stored on the tag.

Restoring an MOB Tag to Factory Default Settings

You can perform a procedure to restore an MOB tag to factory default settings, which clears any custom name or role information stored on the tag.

- 1 Turn on the MOB tag you want to restore to factory default settings.
- 2 Disarm the MOB tag (*Disarming an MOB Tag*, page 146).
You cannot restore an MOB tag when it is in a protected status. You must disarm it first.
- 3 On the MOB tag, press the power button on the side five times.
- 4 Repeat this process for any additional MOB tag you want to restore.

System Bypass

The Garmin OnBoard™ engine cutoff system is designed with two methods you can use to bypass the system. These methods allow you disable engine control and restore typical functionality in the case of an emergency.

Bypassing the System From a Chartplotter

One method to bypass the Garmin OnBoard™ engine cutoff system is by using a connected chartplotter.

NOTE: Bypassing the engine cutoff system using the chartplotter is possible only when the system has cut off the engines due to a man overboard event with a Captain tag, or when testing the system. This option is not available during normal operation.

Within 30 seconds after the system has cut off the engines, select one of these options on a connected chartplotter:

- Select **Yes** in the message that reads **Do you want to be able to restart the engine now?**⁵
- On an MOB screen, select **Disable Cutoff**⁵.
- Select **⚙️ > Communications > NMEA 2000 Setup > Device List**, select the **GOS 10 Hub**, then select **Review > Engine Cutoff > Disable**.

The Garmin OnBoard engine cutoff system is now disabled, and the engines should be restored to previous functionality.

NOTICE

The system remains disabled until you enable it again or until you turn off the system and turn it back on again. You must enable the system as soon as possible to be compliant with the AYBC A-33 standard.

To restore the Garmin OnBoard engine cutoff system functionality, select **⚙️ > Communications > NMEA 2000 Setup > Device List**, select the GOS 10 Hub, then **Review > Engine Cutoff > Enable**.

Bypassing the System from the GOS™ 10 Hub

If bypassing the Garmin OnBoard™ engine cutoff system using a connected chartplotter does not work as expected, or if you prefer to use a different method, you can bypass the system directly from the GOS 10 hub.

- 1 Disconnect the wiring harness from the GOS 10 hub.

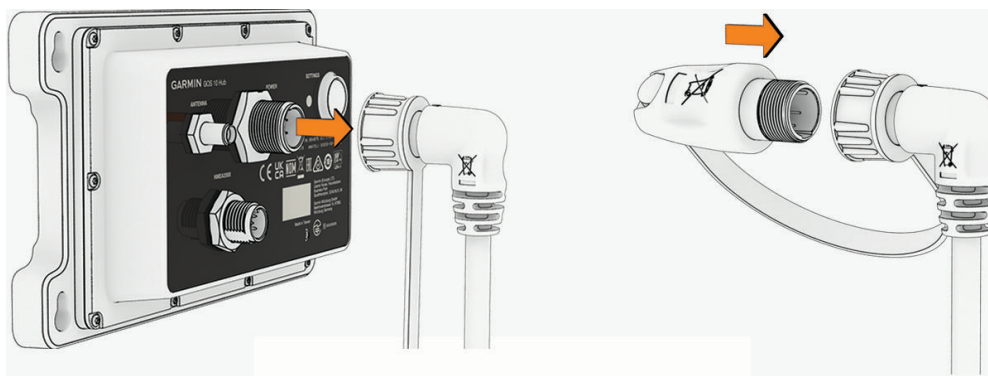

- 2 Connect the bypass module to the wiring harness connector, and tighten the locking ring.

The bypass module should be tethered to the connector end of the wiring harness.

The Garmin OnBoard engine cutoff system is now disabled, and the engines should be restored to previous functionality.

NOTICE

The system remains disabled until you enable it again. You must enable the system as soon as possible to be compliant with the AYBC A-33 standard.

⁵This option is available only during a man-overboard event initiated by an MOB tag with the captain role. This message does not appear when testing the system.

To restore the Garmin OnBoard engine cutoff system again, disconnect the bypass module and reconnect the wiring harness to the GOS 10 hub.

inReach® Messages

⚠ WARNING

Do not read or reply to notifications while operating the vessel. Failure to pay attention to the conditions on the water can result in vessel damage, personal injury, or death.

You can connect a compatible inReach satellite communicator to the chartplotter to view, reply to, and send messages from the chartplotter.

NOTICE

The inReach device must be connected to the chartplotter and receiving satellite signals to send and receive messages using the chartplotter.

Before you can use a connected chartplotter to send and receive messages on a compatible inReach device, you must have an active inReach subscription. See the owner's manual for your inReach device for subscription information.

Messages received and sent by the inReach device are grouped as conversations that are identified using the names or addresses of the contacts included in the messages.

All messages are limited to 160 characters, including the name, address, or phone number of the contact or contacts included in the message. If you send a message to larger groups of contacts, this reduces the available characters for the message itself. When composing a message, the available character information is shown in real time on the chartplotter to help avoid exceeding the character limit.

Connecting an inReach® Device to the Chartplotter

You can connect a compatible inReach device to the chartplotter to manage messages.

- 1 Bring the inReach device within 3 m (10 ft.) of the chartplotter.
- 2 To enable the inReach remote feature on the compatible device, select an option³:
 - On an inReach Mini device, from the main menu, select **Setup > ANT+ > Status > On**.
 - On an inReach Mini 3, inReach Mini 2, inReach Messenger Plus, or inReach Messenger device, from the main menu, select **Settings > inReach Remote > Status > On**.
 - On a GPSMAP® 86i or GPSMAP 67i device, from the main menu, select **Setup > Sensors > inReach Remote > Enabled > On**.
 - On a GPSMAP H1i Plus device, from the main menu, select **Settings > Connectivity > Sensors & Accessories > inReach Remote > Enabled > On**.
- 3 On the chartplotter, select **Vessel > inReach® > Start Pairing**.
The chartplotter begins searching for and connecting to the inReach device. This can take up to 60 seconds.
- 4 If necessary, select **OK** to agree to any informational messages and complete the connection.
- 5 Compare the code shown on the inReach device to code shown on the chartplotter, and select **OK** if they match.

NOTE: On some newer devices, you must select OK on both the inReach device and the chartplotter to complete the connection.

The inReach device and chartplotter connect automatically when they are within range.

Receiving Messages

When your inReach® device receives a message, a pop-up notification appears briefly on the GPSMAP® screen.

- To review the full message, select **View Message**.
- To dismiss the pop-up notification, select **OK** or wait for the notification to close automatically.

Replying to a Message

You can reply to an inReach® message with a pre-written quick message or a custom message.

- 1 From the **inReach®** page, select **Conversations**.
TIP: You can also access inReach conversations from **All Communications > Conversations** in the messages and warnings menu ([Messages and Warnings, page 168](#)).
- 2 Highlight a conversation, and select **View Conversation**.
- 3 Select an option:

³ If your inReach model is not shown, consult the latest Owner's Manual for your inReach device to enable the remote setting.

- To send a quick message, select **Send Quick Message** (*Sending a Quick Message, page 153*).
- To send a custom message, select **Send Custom Message** (*Sending a Custom Message, page 153*).

4 Review the message, and select **Send**.

Sending a Check-In Message

Check-in messages are predefined messages that you prepare for specific contacts using the Garmin Messenger™ app or on your account at explore.garmin.com. You cannot customize the text of check-in messages, only the contacts who will receive it.

1 From the **inReach®** page, select **Conversations > Send Check-In Message**.

TIP: You can also access inReach® conversations from **All Communications > Conversations** in the messages and warnings menu (*Messages and Warnings, page 168*).

2 Select a preset or check-in message.

3 Select **Send**.

Starting a New Conversation

1 From the **inReach®** page, select **Conversations > Start Conversation**.

TIP: You can also access inReach® conversations from **All Communications > Conversations** in the messages and warnings menu (*Messages and Warnings, page 168*).

2 Add recipients:

- To include an existing contact in the conversation, highlight the contact, and select **Include**.
- To include a new contact in the conversation, select **Enter New Recipient**, and provide the phone number, email address, or inReach address for the new contact.

3 Select an option:

- To send a quick message, select **Send Quick Message** (*Sending a Quick Message, page 153*).
- To send a custom message, select **Send Custom Message** (*Sending a Custom Message, page 153*).

4 Review the message details, and select **Send**.

Sending a Quick Message

Quick messages are predefined messages that you prepare on your account at explore.garmin.com. Quick messages contain custom text, and are not assigned to a specific contact in your account. They can be used as needed when sending or replying to inReach® messages on the chartplotter.

1 From the **inReach®** page, select **Conversations**.

TIP: You can also access inReach conversations from **All Communications > Conversations** in the messages and warnings menu (*Messages and Warnings, page 168*).

2 Select an existing conversation or start a new conversation (*Starting a New Conversation, page 153*).

3 Select **Send Quick Message**, and select the preset message to send.

4 Review the message, and select **Send**.

Sending a Custom Message

1 From the **inReach®** page, select **Conversations**.

TIP: You can also access inReach® conversations from **All Communications > Conversations** in the messages and warnings menu (*Messages and Warnings, page 168*).

2 Select an existing conversation or start a new conversation (*Starting a New Conversation, page 153*).

3 Select **Send Custom Message**.

4 Compose the message, and select **Done**.

5 Review the message, and select **Send**.

inReach® SOS Calls

WARNING

Before you can use the SOS function, you must have an active satellite subscription on the connected inReach device. Always test your device before you use it outdoors.

Ensure the inReach device has a clear view of the sky when using the SOS function, because this feature requires satellite access to operate properly.

NOTICE

Some jurisdictions regulate or prohibit the use of satellite communications devices. It is the responsibility of the user to know and follow all applicable laws in the jurisdictions where the device is intended to be used.

When a compatible inReach device is paired to the chartplotter, you can contact the Garmin ResponseSM center to request help. From the chartplotter, you can initiate, cancel, and monitor the status of an inReach SOS call, as well as communicate with the Garmin Response team while you wait for help to arrive.

You should only use the SOS function in a real emergency situation.

Sending an inReach[®] SOS Call

You must pair a compatible inReach device with your chartplotter before you can send an inReach SOS call using the chartplotter.

- 1 From any screen, select **SOS**.
- 2 Select the SOS type.
- 3 Select **Activate inReach SOS**.

The chartplotter initiates an SOS call from the paired inReach device, and creates an entry on the Conversations page. You can communicate with the Garmin ResponseSM team using this conversation.

⚠ CAUTION

When an inReach SOS call is active do not turn off or attempt to turn off the inReach device or connected chartplotter. Doing so could prevent this feature from operating properly and could delay receipt of assistance in the event of an emergency

Communicating with the Garmin ResponseSM Team During an SOS Call

- 1 Send an inReach[®] SOS call (*Sending an inReach[®] SOS Call*, page 154).
A new entry for the SOS call appears in the Conversations page. The SOS conversation appears in red text.
- 2 Select the SOS conversation, and select **View Conversation** to view replies from the Garmin Response team.
NOTE: Replies from Garmin Response team also appear as message banners when received by the chartplotter, and you can access new messages from the Warning Manager.
- 3 Select one or more actions:
 - To view the full reply from the Garmin Response team, select the reply, and select **View Message**.
 - To reply to the Garmin Response team, select **Send Quick Message** or **Send Custom Message**.
 - To send information about your vessel to the Garmin Response team, select **Send Vessel Data**.

Cancelling an inReach[®] SOS Call

You can cancel an inReach SOS call you sent using the chartplotter.

- 1 From the **inReach[®]** page, select **Conversations**.
TIP: You can also access inReach conversations from **All Communications > Conversations** in the messages and warnings menu (*Messages and Warnings*, page 168).
- 2 Select the SOS conversation you want to cancel.
- 3 Select **Cancel SOS**, and confirm that you want to cancel the SOS call.

Changing inReach[®] Tracking Settings

You can change the tracking settings on a connected, compatible inReach device. See the owner's manual for your inReach device for more information about the tracking feature.

NOTE: The tracking feature is not available on all inReach models.

- 1 From the **inReach[®]** page, select **Tracking**.
- 2 To turn on tracking, select **Tracking**.
- 3 To adjust the frequency at which the device records a track point and transmits it over the satellite network, select **Send Interval**, and select a value.

The tracking settings are automatically updated on the connected, compatible inReach device.

Digital Switching

Your chartplotter can be used to monitor and control circuits when connected to a compatible digital switching system.

For example, you can control the interior lights and navigation lights on the vessel. You can also monitor live well circuits.

For more information about purchasing and configuring a digital switching system, contact your Garmin® dealer.

Adding and Editing a Digital Switching Page

You can add and customize digital switching pages on the chartplotter.

- 1 Select **Vessel > Switching > Options > Setup**.
- 2 Select **Add Page** or **Edit Page**.
- 3 Set up the page as needed:
 - To enter a name for the page, select **Name**.
 - To set up the switches, select **Edit Switches**.
 - To add an image of the boat, select **Add BoatView Image**.

NOTE: You can use the default vessel image or use a custom image of your vessel. You should save the custom image to the /Garmin folder on the memory card. You can also adjust the view and placement of the image.

Garmin Boat Switch™

WARNING

Garmin® strongly recommends using a professional installer with proper knowledge of electrical systems to install the device. Incorrectly installing the device can result in serious bodily injury and damage to the vessel or the battery.

Configuring the Garmin Boat Switch™ Device

Some digital switches controlled by the Garmin Boat Switch device must be configured before use.

Configuring a Switch as Momentary

All latching and momentary channels on the Garmin Boat Switch™ device must be configured in the chartplotter software as momentary switches for proper operation.

- 1 From a Garmin® chartplotter connected to the same NMEA 2000® network as the Garmin Boat Switch device, select  > **My Vessel > Switching > NMEA Standard**.
- 2 Select the switch number.
- 3 Select **Configuration > Momentary**.

Naming a Switch

You can provide a custom name to be used instead of the default name for each switch.

- 1 From a Garmin® chartplotter connected to the same NMEA 2000® network as the Garmin Boat Switch™ device, select  > **My Vessel > Switching > NMEA Standard**.
- 2 Select the switch number.
- 3 Select **Name > Change Name**.
- 4 Enter a new name.
- 5 Select **Done**.

Labeling a Switch

You can provide a custom label for each switch. The switch label is separate from the switch name.

- 1 From a Garmin® chartplotter connected to the same NMEA 2000® network as the Garmin Boat Switch™ device, select  > **My Vessel > Switching > NMEA Standard**.
- 2 Select the switch number.
- 3 Select **Label > Edit Label**.
- 4 Enter a new label.
- 5 Select **Done**.

Showing and Hiding Switches

You can select which switches are hidden or displayed on the Garmin® chartplotter.

- 1 From a Garmin chartplotter connected to the same NMEA 2000® network as the Garmin Boat Switch™ device, select **⚙️ > My Vessel > Switching > NMEA Standard**.
- 2 Select the switch number.
- 3 Select **Visibility** to show or hide the switch.

Configuring the Navigation Light Option

NOTICE

It is your responsibility to comply with applicable laws, regulations, and standards related to the use and/or operation of marine navigation lights. Garmin® is not responsible for any fines, penalties, citations, or damages that may be incurred due to any such lack of compliance.

By default, channels 1 and 2 are interlocked for navigation lighting to satisfy the international regulations for preventing collisions at sea. Depending on the lighting specifics of your boat, you may need to configure the Garmin Boat Switch™ device to use the wiring option you that applies to your installation type.

If you do not intend to connect navigation and anchor lights to the device, you can configure channels 1 and 2 to operate independently as normal latching switches.

- 1 From a Garmin chartplotter connected to the same NMEA 2000® network as the Garmin Boat Switch device, select **Vessel > Switching**.
- 2 Press and hold switch 1 for 5 seconds.
Switch 1 starts flashing.
- 3 Press and hold switch 2 for 5 seconds.
The switch stops flashing, and a message confirms the newly selected wiring option.
- 4 Repeat the previous two steps until the device is configured for the wiring option that applies to your installation type.

NOTE: After selecting option C, the next configuration option in the cycle deactivates the interlocks so that channels 1, 2, and 3 operate independently as normal latching switches.

Using the Bilge Pump Switches

You can manually operate connected bilge pumps by using switches 12 and 13 on the Garmin® chartplotter.

- 1 From a Garmin chartplotter connected to the same NMEA 2000® network as the Garmin Boat Switch™ device, select **Vessel > Switching**.
- 2 Select an option:
 - Press and hold the bilge pump switch for one second to run the bilge pump for 2 minutes.
 - Press and hold the bilge pump switch for three seconds to run the bilge pump continuously.
Your Garmin chartplotter notifies you every 5 minutes while continuous mode is active.

Using Dimmable Lights

You can operate connected dimmable lights by using switches 17 through 21 on the Garmin® chartplotter.

- 1 From a Garmin chartplotter connected to the same NMEA 2000® network as the Garmin Boat Switch™ device, select **Vessel > Switching**.
- 2 Select an option:
 - Press a dimmable light switch to turn a light on or off.
NOTE: The light turns on at the dim level set when the light was last turned off.
 - With a light on, press and hold a dimmable light switch dim the light, and release to stop dimming.
 - With a light off, press and hold a dimmable light switch to turn on the light at 100% brightness.

Configuring Digital Switches for Voice Control

Before you can use the voice control feature on the chartplotter to control switched devices using your Garmin Boat Switch™ device, you must assign details about the devices connected to each switch you want to control.

- 1 From a Garmin® chartplotter connected to the same NMEA 2000® network as the Garmin Boat Switch device, select **⚙️ > My Vessel > Switching > Voice Control**.
- 2 Select the switched channel you want to configure for voice control, then select **Select Type**.
- 3 Select the type of device connected to the switched channel, then select **Set Type**.
- 4 If needed, perform any additional configurations for the channel and device:
 - If you have more than one type of device on the boat and you need to add an identifying number (ex. light 1, light 2, etc.), select **Select Identity**, select a number to assign to the device, then select **Set Identity**.

- If you want to see examples of how you can use voice control for the device, select **Show Examples**.
- If you made mistakes and want to reset the voice control settings for the device, select **Reset**.

After you have set the type and optional identity information for devices connected to the Garmin Boat Switch device, you can use voice control to interact with them (*Chartplotter Voice Commands, page 28*).

Device Types For Voice Control

Because the Garmin Boat Switch™ device is preconfigured for specific device types on certain channels, you can refer to this table to help verify that you are assigning the appropriate details to each channel you want to use with voice control.

Channel ⁴	Device Types
1	<ul style="list-style-type: none"> • Red/green navigation light grouping • Red/green/white light grouping • Generic latching device
2	<ul style="list-style-type: none"> • White/anchor navigation light grouping • Anchor light • Steaming light • Generic latching device
3	<ul style="list-style-type: none"> • Anchor light • Generic latching device
4	Generic latching device
5	Generic latching device
9	Generic latching device
10	Generic latching device
11	Live well pump
12	Bilge pump
13	Bilge pump
17	Generic latching device (dimnable)
18	Generic latching device (dimnable)
19	Generic latching device (dimnable)
20	Generic latching device (dimnable)
21	Generic latching device (dimnable)
25	<ul style="list-style-type: none"> • Horn • Generic momentary device
26	<ul style="list-style-type: none"> • Horn • Generic momentary device
27	<ul style="list-style-type: none"> • Horn • Generic momentary device

Controlling Third-Party Equipment Installed on Your Boat

Power-Pole® Anchor System

⚠ WARNING

Do not engage the Power-Pole Anchor System while underway. Doing so could cause result in an accident causing property damage, serious personal injury, or death.

If a compatible Power-Pole anchor system is connected to the NMEA 2000® network, you can use the chartplotter to control the Power-Pole anchor. The chartplotter automatically detects the Power-Pole anchor system's C-Monster® gateway on the NMEA 2000 network.

Enabling the Power-Pole® Anchor or CHARGE™ Overlay

You must enable an overlay on the chartplotter to control the Power-Pole anchor system or a CHARGE power management system on your vessel.

1 From the page to which you will add the overlay, select **Options > Edit Overlays**.

TIP: To quickly select the overlay, select **Toolbars** then Anchor or Charge.

2 Select where you want to add the overlay.

3 Select **Power-Pole® Anchor** or **Power-Pole® Charge**.

After you enable the Power-Pole overlay on the chartplotter, you must set the Power-Pole installation mode to match the Power-Pole anchor installation on the boat ([Setting Up the Power-Pole® Anchor, page 158](#)).

Setting Up the Power-Pole® Anchor

Before you can use the chartplotter to control the Power-Pole anchor, you must select the required installation mode.

The default initial installation mode setting is None. While the installation mode is set to None, the chartplotter control of the Power-Pole anchor(s) is inactive.

1 From the Power-Pole toolbar, select **≡ > Installation**.

2 Select the installation mode that matches the anchor installation on the boat.

- To control a single port side Power-Pole anchor, select **Port**.
- To control a single starboard side Power-Pole anchor, select **Starboard**.
- To control dual Power-Pole anchors, select **Dual**.







3 Use the slider to set the desired speed for the anchor to deploy and retract.

Power-Pole® Overlay

Before you can control the Power-Pole anchor with the chartplotter, you must enable the overlay ([Enabling the Power-Pole® Anchor or CHARGE™ Overlay, page 158](#)) and set the Power-Pole installation mode ([Setting Up the Power-Pole® Anchor, page 158](#)).

The layout of the overlay varies based on the installation mode. Refer to your Power-Pole documentation for more information.



	Select to control both anchors simultaneously Deselect to control the anchors independently
	Select to fully retract the anchor
	Select to fully extend the anchor
	Hold to retract the anchor manually Release to stop the anchor
	Hold to extend the anchor manually Release to stop the anchor
	Select to open the menu

	Select to enable the advanced boat control feature NOTE: This option is available only when connected to a compatible Garmin® trolling motor
PORT	Port side anchor control buttons
STBD	Starboard side anchor control buttons

Power-Pole® Advanced Boat Control

When the chartplotter is connected to a compatible Garmin® trolling motor and a compatible Power-Pole anchor system, you can enable advanced boat control functions that use both the Power-Pole anchors and the trolling motor.

NOTE: You must enable Anchor Lock on the trolling motor before you can enable advanced boat control.

From the Power-Pole overlay, select  to enable these advanced boat control functions.

NOTE: The first time you enable advanced boat control, you must perform a one-time process to set the max depth and drag sensitivity. These settings can be adjusted later from the menu on the Power-Pole overlay.

Smart Anchor Selection: The system determines when to use the Anchor Lock function on the trolling motor or the Power-Pole anchor system.

Drag Detection: If the Power-Pole shallow water anchors fail to hold the vessel's position, the anchors are stowed automatically, the trolling motor attempts to return the vessel to the original position, and it redeploys the anchors.

Anchor Jog: When using the trolling motor to move to a different anchor location, the system automatically stows the anchors if necessary until the jog procedure is complete. The system then determines whether to redeploy the anchors or use the trolling motor Anchor Lock function depending on the depth.

Trolling Motor Direction Control: When the Power-Pole anchors are deployed, you can rotate the angle of the trolling motor as needed. This is helpful when you are using LiveScope™ on the trolling motor and you want to view a different angle while anchored.

Auto-Stow: The system automatically stows Power-Pole anchors when you stow the trolling motor.

If you want to continue using the Power-Pole anchors when stowing the trolling motor, you must disable advanced boat control from the Power-Pole overlay.

CHARGE™ Overlay





Before you can add the CHARGE overlay, you must install a CHARGE power management system on your vessel and connect it to a C-Monster® control system. Both of these systems are Power-Pole® products and not produced by Garmin®. After installing this hardware, you must configure the CHARGE power management system and the C-Monster control system so the chartplotter can access and control the charge functions. See the owner's manual provided with your CHARGE power management system for more information.

After installing and configuring the CHARGE power management system, you can enable the CHARGE overlay to control the system using the chartplotter ([Enabling the Power-Pole® Anchor or CHARGE™ Overlay, page 158](#)).

The layout of the overlay varies based on the size of the chartplotter model. Smaller models may show less text, but the functions are the same.



The screenshot shows the CHARGE overlay interface. It features three main sections: 1. Engine battery status (left), 2. CHARGE priority setting (center), and 3. Auxiliary battery status (right). The priority setting is a horizontal bar with a lightning bolt icon in the center, flanked by 'Max Eng.', 'Mid Eng.', 'Balanced', 'Mid Aux.', and 'Max Aux.' labels. The auxiliary battery status shows three 12.5v battery icons. Below the screenshot is a legend table.

	Engine battery status.
	CHARGE priority setting. You can select an icon to quickly adjust the priority between the engine and the auxiliary batteries. The color of the bar indicates the battery-charging status. When a battery is being charged, the bar near that battery appears green. When a battery is not receiving a charge, the bar near that battery appears gray.
	Auxiliary battery status.
	Indicates that a battery is charging.
	Indicates that a battery either is not charging or is being discharged into the other battery.

	Indicates that the CHARGE power management system is connected to shore power.
Emergency Transfer	Select to start an emergency transfer of power from the auxiliary battery or batteries to the engine battery.

Enabling the Mercury® Helm

WARNING

You are responsible for the safe and prudent operation of your vessel. The Mercury Helm does not steer the boat for you and does not avoid navigational hazards. Failure to safely operate your boat could result in an accident causing property damage, serious personal injury, or death.

With a Mercury engine configured to operate with the Mercury Helm engine control feature on the chartplotter, you can enable one helm as the active Mercury Helm. The active Mercury Helm controls the Mercury engines and Mercury chartplotter engine control overlays (for example Mercury Cruise). The overlays at non-active helms are visible but disabled, so that users at a non-active helm cannot accidentally control the engine.

As you move around the boat, you can change the active Mercury Helm from station to station, up to four.

- 1 Select **Settings** > **System** > **Station Information** > **Mercury Helm**.
- 2 Make a selection.

Mercury® Troll Control Features

WARNING

You are responsible for the safe and prudent operation of your vessel. The Mercury troll control features do not steer the boat for you and do not avoid navigational hazards. Failure to safely operate your boat could result in an accident causing property damage, serious personal injury, or death.

When connected to a compatible Mercury engine, you can use the Mercury Troll overlay to set and adjust the trolling speed from the chartplotter.

Adding the Mercury® Troll Control Overlay





When connected to a compatible Mercury engine, you can set and adjust the target speed using the Mercury Troll overlay on the chartplotter.

- 1 From the page where you want to add the overlay, select **Options** > **Edit Overlays**.
TIP: You can also select Toolbars from the menu bar to quickly change the overlays.
- 2 Select **Top Bar**, **Bottom Bar**, **Left Bar**, or **Right Bar**.
- 3 Select **Mercury Troll**.
- 4 Select **Back**.

Mercury® Troll Overlay

When connected to a compatible Mercury engine, you can use the Mercury Troll overlay on the chartplotter to set a target speed.



	Select to decrease the target speed
	Target speed
	Select to increase the target speed
	Actual speed
Enable	Select to engage the Mercury Troll feature
Disable	Select to disengage the Mercury Troll feature

Mercury® Cruise Control

⚠ WARNING

You are responsible for the safe and prudent operation of your vessel. Mercury Cruise Control does not steer the boat for you and does not avoid navigational hazards. Failure to safely operate your boat could result in an accident causing property damage, serious personal injury, or death.

When connected to a compatible Mercury engine, you can set and adjust the cruise-control function using the chartplotter.

Enabling the Mercury® Cruise Control Overlay

- 1 From the page where you want to add the overlay, select **Options > Edit Overlays**.
TIP: You can also select Toolbars from the menu bar to quickly change the overlays.
- 2 Select **Top Bar, Bottom Bar, Left Bar, or Right Bar**.
- 3 Select **Mercury Cruise**.
- 4 Select **Back**.

Mercury® Cruise Control Overlay

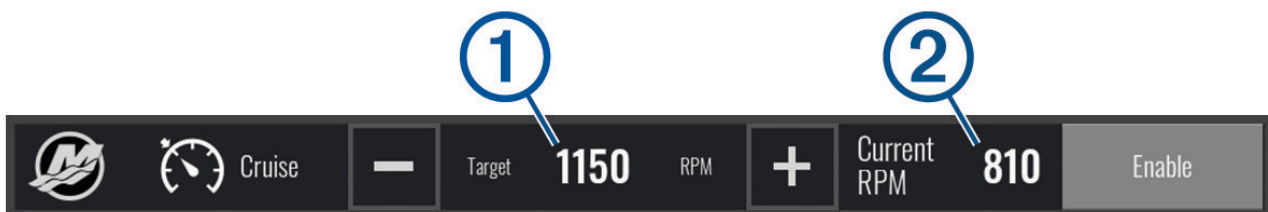

—	Select to decrease the target speed
①	Target speed
+	Select to increase the target speed
②	Actual speed
Enable	Select to engage the cruise control
Disable	Select to disengage the cruise control

Mercury® Engine Details

⚠ WARNING

You are responsible for the maintenance of the engines on your vessel. Failure to properly maintain the engines could result in an accident causing property damage, serious personal injury, or death.

When your chartplotter is connected to a compatible Mercury engine, you can view engine data using the Mercury Engine overlay on the chartplotter.

Adding the Mercury® Engine Overlay

- 1 From the page where you want to add the overlay, select **Options > Edit Overlays**.
TIP: You can also select Toolbars from the menu bar to quickly change the overlays.
- 2 Select **Top Bar, Bottom Bar, Left Bar, or Right Bar**.
- 3 Select **Mercury Engine**.
- 4 Select **Back**.

Mercury® Engine Overlay

You can use the Mercury Engine Overlay to view engine data ([Adding the Mercury® Engine Overlay, page 161](#)). Due to space constraints on the overlay, some items may not appear if the vessel has multiple engines.



①	Port engine RPM
②	Starboard engine RPM
③	Total available fuel
④	Fuel usage
⑤	Sport Exhaust control (if supported) (<i>Enabling the Mercury® Engine Sport Exhaust Setting, page 162</i>)

TIP: You can also view an overview of engine details on the Mercury gauges page (*Mercury® Engine Gauges, page 140*).

Enabling the Mercury® Engine Sport Exhaust Setting

When your chartplotter is connected to a compatible Mercury engine, you can use the Mercury Engine overlay on the chartplotter to enable the Sport Exhaust setting. The Sport Exhaust setting alters the engine sound.

On the **Mercury Engine** overlay, select **Sport Exhaust > On**.

TIP: You can select Toolbars from the menu bar to quickly open the overlay.

TIP: You can also enable the Sport Exhaust setting from the Mercury gauges page menu.

Mercury® Active Trim Control

⚠ WARNING

You are responsible for the safe and prudent operation of your vessel. Mercury Active Trim Control does not control boat speed, does not steer the boat for you, and does not avoid navigational hazards. Failure to safely operate your boat could result in an accident causing property damage, serious personal injury, or death.

When your chartplotter is connected to a compatible Mercury Active Trim system, you can control the system using the Active Trim overlay on the chartplotter.

Adding the Mercury® Active Trim Overlay

1 From the page where you want to add the overlay, select **Options > Edit Overlays**.

TIP: You can also select Toolbars from the menu bar to quickly change the overlays.

2 Select **Top Bar, Bottom Bar, Left Bar, or Right Bar**.

3 Select **Active Trim**.

Mercury® Active Trim Overlay



①	When enabled, you can manually adjust the trim.
②	When enabled, you can change between Mercury active trim preset profiles.
③	Active trim system status.
Enable or Disable	Select to turn the active trim system on or off.

Skyhook® Digital Anchor Control

⚠ WARNING

You are responsible for the safe and prudent operation of your vessel. The Skyhook digital anchor features do not avoid navigational hazards. Failure to safely operate your boat could result in an accident causing property damage, serious personal injury, or death.

When connected to a compatible Mercury® engine, you can use the Skyhook digital anchor overlay on the chartplotter to set and adjust the digital anchor functions.

Depending on the type of hardware installed on your vessel, the Skyhook digital anchor overlay has a different appearance with different controls:

- Original Skyhook digital anchor (*Original Skyhook Digital Anchor Overlay, page 163*).
- Skyhook 2.0 digital anchor (*Skyhook Digital Anchor 2.0 Overlay, page 163*).

Adding the Skyhook® Digital Anchor Control Overlay

When connected to a compatible Mercury® engine, you can add an overlay on the chartplotter to control the Skyhook digital anchor functions.

- 1 From the page where you want to add the overlay, select **Options > Edit Overlays**.
TIP: You can also select Toolbars from the menu bar to quickly change the overlays.
- 2 Select **Top Bar, Bottom Bar, Left Bar, or Right Bar**.
- 3 Select **Mercury Skyhook**.
- 4 Select **Back**.

Original Skyhook Digital Anchor Overlay

When connected to a compatible Mercury® engine featuring the original Skyhook® digital anchor hardware, you can use the Skyhook overlay shown below on the chartplotter to control the Skyhook digital anchor functions.

TIP: When the Skyhook digital anchor, Drifthook feature, or Bowhook feature is active, you can select Standby on the menu bar to disengage the active digital anchor feature and resume manual control of the boat.



①	Information about the current heading and steering adjustments.
◀◀	Adjusts the intended heading to port. The system steers the boat to the new heading.
▶▶	Adjusts the intended heading to starboard. The system steers the boat to the new heading.
Drifthook	Changes to Drifthook functionality. When Drifthook is active, the boat attempts to maintain heading, but the position may change.
Bowhook	Changes to Bowhook functionality. When Bowhook is active, the boat attempts to keep the same position, but the heading may change.

Skyhook Digital Anchor 2.0 Overlay

When connected to a compatible Mercury® engine featuring the updated 2.0 version of the Skyhook® digital anchor hardware you can use the Skyhook overlay shown below on the chartplotter to control the Skyhook digital anchor functions.

TIP: When the Skyhook digital anchor features are active, you can select Standby on the menu bar to disengage the active digital anchor feature and resume manual control of the boat.

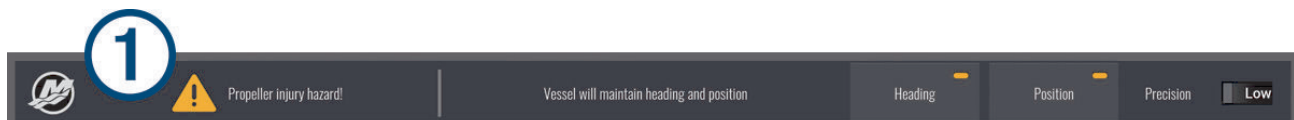

①	Information about the current status of the Skyhook digital anchor and any warning messages.
Heading	When active, the boat attempts to maintain heading, but the position may change.
Position	When active, the boat attempts to keep the same position, but the heading may change.
Precision	Toggles the precision level used by the system to maintain the position or heading.

Adding the Skyhook® Joystick Overlay

If your vessel also has a physical joystick used to control the Skyhook digital anchor, you can add an additional overlay bar to quickly adjust the joystick settings.

- 1 From the page where you want to add the overlay, select **Options > Edit Overlays**.
TIP: You can also select Toolbars from the menu bar to quickly change the overlays.
- 2 Select **Top Bar, Bottom Bar, Left Bar, or Right Bar**.
- 3 Select **Joystick**.
- 4 Select **Back**.

Dometic® Optimus® Features

When connected to a compatible Optimus system, the chartplotter allows you to access and control the system. You can enable the Optimus overlay to control the Optimus system ([Activating the Optimus® Overlay Bar, page 164](#)).

When necessary, the Optimus system provides messages with information, instructions, and alerts about faults and hazards.

A no swimming icon  indicates that you should not swim when certain Optimus modes are active. In these modes, propeller control is automatic and could injure someone in the water.

Activating the Optimus® Overlay Bar

- 1 From a chart, select **Options > Edit Overlays**.
- 2 Select **Top Bar, Bottom Bar, Left Bar, or Right Bar**.
- 3 Select **Optimus Bar**.

Optimus® Overlay Bar Overview

To use the overlay bar, you must connect your Optimus system to your chartplotter and add the overlay bar to the necessary screens ([Activating the Optimus® Overlay Bar, page 164](#)).

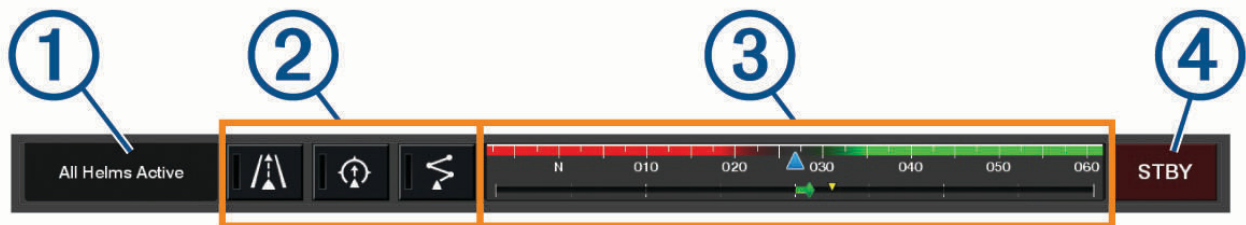





①	Control mode
②	Optimus control buttons
③	Rudder
④	Standby button

You must press a mode button on the overlay bar to engage or disengage the mode. When the mode is engaged, the button is illuminated.

The overlay bar configuration and buttons vary, based on systems, modes, and equipment. Refer to your Optimus documentation for more information.

Optimus® Overlay Symbols

	Autopilot heading hold
	Autopilot track mode
	Autopilot route mode
	SeaStation® position hold
	SeaStation heading hold

Optimus® Limp Home Mode

WARNING

In the event of a steering failure, Optimus Limp Home mode becomes available. Limp Home mode is a system override that may severely limit your boat's control. It should only be used in an emergency if you are unable to call for assistance. Proceed with extreme caution. Read the Optimus owner's manual and always wear a personal flotation device (PFD).

You are responsible for the safe and prudent operation of your vessel. Use of Limp Home mode does not relieve you of the responsibility of safely operating your boat. Avoid navigational hazards and never leave the motor controls unattended.

When available, the Limp Home button appears on the Optimus overlay bar. Refer to the Optimus owner's manual before using Limp Home mode.

To engage Limp Home mode from any screen, select **Where To > Warning Manager > Steering Limp Home**.

Tide, Current, and Celestial Information

Tide and Current Overlays

1



2

1	Tide station overlay bar.
2	Current station overlay bar.
3	Name of the selected tide or current station. Select to change to a different tide or current station.
4	Tide or current station graph.
5	Present time, indicated on the tide or current station graph as a white line. You can select < and > to adjust the time on the tide or current station graph.
6	Present sunrise and sunset times.
< >	Select to open the tide or current station information page.

Adding Tide and Current Overlays

- From the page where you want to add the overlay, select **Options > Edit Overlays**.
TIP: You can also select Toolbars from the menu bar to quickly change the overlays.
- Select **Top Bar, Bottom Bar, Left Bar, or Right Bar**.
- Select **Tides** or **Currents**.

Tide Station Information

⚠ WARNING

Tide and current information is for information purposes only. It is your responsibility to heed all posted water-related guidance, to remain aware of your surroundings, and to use safe judgment in, on, and around the water at all times. Failure to heed this warning could result in property damage, serious personal injury, or death.

You can view information about a tide station for a specific date and time, including the tide height, and when the next high and low tides will occur. By default, the Tides overlay bar on the chartplotter shows tide information for the most recently viewed tide station, present date, and past hour.

From the Tides overlay bar, select < >.

Current Station Information

⚠ WARNING

Tide and current information is for information purposes only. It is your responsibility to heed all posted water-related guidance, to remain aware of your surroundings, and to use safe judgment in, on, and around the water at all times. Failure to heed this warning could result in property damage, serious personal injury, or death.

NOTE: Current station information is available with certain detailed maps.

You can view information about a current station for a specific date and time, including the current speed and level of the current. By default, the Currents overlay bar on the chartplotter shows current information for the most recently viewed current station and for the present date and time (*Tide and Current Overlays, page 166*).

From the Currents overlay bar, select .

Celestial Information

You can view information about sunrise, sunset, moonrise, moonset, moon phase, and the approximate sky view location of the sun and moon. The center of the screen represents the sky overhead, and the outermost rings represent the horizon. By default, the chartplotter shows celestial information for the present date and time.

From the Tides or Currents overlay bar, select , then select **Celestial**.

Viewing Tide Station, Current Station, or Celestial Information for a Different Date

- 1 From a **Tides** or **Currents** overlay bar, select .
- 2 To view celestial information, select **Celestial**.
- 3 Select an option:
 - To view information for a different date, select **Change Date**, and enter a date.
 - To view information for today, select **Current Date and Time**.
 - If available, to view information for the day after the date shown, select **Next Day**.
 - If available, to view information for the day before the date shown, select **Previous Day**.

Viewing Information for a Different Tide or Current Station

- 1 From a **Tides** or **Currents** overlay bar, select .
- 2 Select **Nearby Stations**.
- 3 Select a station.



Viewing Almanac Information from the Navigation Chart

- 1 From a chart or 3D chart view, select a tide station or a current station icon.
- 2 Select the name of the station.

Messages and Warnings

You can open a menu to view important messages and warnings, and to access other communications such as DSC.

Select .

During an active warning, an indicator () replaces the icon on the menu bar (). This color-coded icon conveys the nature of the warning, and if you have more than one message to review, it prioritizes the highest-severity warning.

Color	Severity
Red	Hazards that require immediate action to avoid severe personal injury or death
Yellow	Hazards or unsafe practices which could result in minor personal injury or product or property damage

Viewing Messages and Warnings

1 Select .

NOTE: This appears as an indicator () if there is an active warning.
A window opens that shows messages and any active warnings.

2 Select an option:

- Select a message or an active warning.
- Select **All Communications > Alarm History**.

3 If necessary, select an item in the list.

4 Select **Review**.

Sorting and Filtering Messages

1 Select .

NOTE: This appears as an indicator () if there is an active warning.

2 Select **All Communications > Alarm History > Sort/Filter**.

3 Select an option to sort or filter the message list.

Saving Messages to a Memory Card

1 Insert a memory card into the card slot.

2 Select .

NOTE: This appears as an indicator () if there is an active warning.

3 Select **All Communications > Alarm History > Save to Card**.

Clearing all Messages and Warnings

1 Select .

NOTE: This appears as an indicator () if there is an active warning.

2 Select **All Communications > Alarm History > Clear Alarm History**.

Media Player

If you have a compatible stereo or stereos connected to the chartplotter, you can control the audio using the media player on the chartplotter:

- If you have a compatible Fusion® stereo connected to the NMEA 2000® network or the Garmin® Marine Network, you can control the stereo using the chartplotter. The chartplotter should automatically detect the stereo.
- If you have multiple Fusion stereos connected to one another using Fusion PartyBus™ networking, you can control the networked stereos and groups using the chartplotter. As long as you have one of the networked Fusion stereos connected to the NMEA 2000 network or the Garmin Marine Network, the chartplotter should automatically detect the stereos.
- If you have a compatible third-party stereo connected to the NMEA 2000 network, you may be able to control the stereo using the chartplotter.

NOTE: Not all features are available on all connected stereos.

NOTE: You can play media only from sources that are connected to the stereo.

Opening the Media Player

Before you can open the media player, you must connect a compatible device to the chartplotter.

Select **Vessel > Media**.

TIP: To quickly add the media overlay to a page, select **Toolbars > Media > Add**.

Media Player Icons

NOTE: Not all devices have these icons.

Icon	Description
★	Saves or deletes a channel as a preset
↺↻	Repeats all songs
↺↻	Repeats one song
⏮ ⏭	Scans for AM/FM radio stations Skips to next or previous track (tap) Fast forwards or rewinds (hold)
↻	Shuffles
🔊+	Increases the volume
🔊-	Decreases the volume
🔊×	Mutes volume
⏏	Expands the media player to full screen

Selecting the Media Device and Source

You can select the media source connected to the stereo. When you have multiple stereo or media devices connected on a network, you can select the device from which you want to play music.

NOTE: You can play media only from sources that are connected to the stereo.

NOTE: Not all features are available on all media devices and sources.

- 1 From the media screen, select **Devices**, and select the stereo.
- 2 From the media screen, select **Source**, and select the media source.

NOTE: The Devices button only appears when more than one media device is connected to the network.

NOTE: The Source button only appears for devices that support multiple media sources.

Adjusting the Volume and Audio Levels

Adjusting the Volume



If your vessel's media system is set up in zones, the volume controls on the media screen adjust the volume for the Home Zone ([Selecting the Home Zone, page 171](#)).

From the media screen, use the slider or 🔊- and 🔊+ to adjust the volume.

Adjusting the Audio Level

You can use the equalizer to adjust the audio levels on a connected media device.

If the media system has multiple zones, adjusting the audio level tone controls affects the home zone only. You can change the home zone to adjust the audio levels in other zones ([Selecting the Home Zone, page 171](#)).

- 1 From the media screen, select **Options > Audio Levels**.
- 2 Select - or + to adjust the audio levels you want to change.

Muting the Media Volume

- 1 From the media screen, select  x.
- 2 If necessary, select **Select**.

Automatic Volume Adjustment Based on Speed

If your stereo is connected to a NMEA 2000® network with a device that provides speed information such as an engine, chartplotter, GPS antenna, water speed sensor, or wind speed sensor, you can set the stereo to adjust the volume automatically based on the selected speed source ([Enabling Automatic Volume Adjustment Based on Speed, page 170](#)).

For example, if a chartplotter with an internal GPS antenna or a stand-alone GPS antenna is on the same NMEA 2000 network as the stereo and you set the Speed Source to Speed Over Ground, the volume increases as your speed increases.

NOTE: When the volume increases to adjust for speed, the actual volume output changes, but the volume-level indicator bar and number stays the same.

For more information about connecting the stereo to a NMEA 2000 network, see the installation instructions for your stereo.

Enabling Automatic Volume Adjustment Based on Speed

- 1 From the **Media** screen, select **Options > Installation**.
- 2 Select the name of the stereo.
- 3 Select **Zones > Speed Vs Volume > Enable**.
- 4 If needed, update the settings to select the speed source and volume settings.

Automatic Volume Control Settings

Select **Options > Installation**, select the name of the stereo, then select **Zones > Speed Vs Volume**.

Enable: Enables the automatic volume control feature.

Speed Source: Sets the source that the stereo uses to determine the speed ([Speed Source Information, page 170](#)).

Max/Min Speed: Sets the expected maximum and minimum speed range for the selected Speed Source. The Minimum setting indicates the speed at which the volume plays at the level you set by turning the dial. The Maximum setting indicates the speed at which the volume plays at the highest level set in the Volume Increase setting.

TIP: You should start by setting these values at the speeds you typically expect from your engine or sensor and adjust them as needed.

Volume Increase: Sets the total volume increase for each zone when the selected Speed Source reaches the set maximum speed set in the Max/Min Speed setting. The higher you set this level, the louder the volume will be as you approach the set maximum speed.

NOTE: When the volume increases to adjust for speed, the actual volume output changes but the volume-level indicator bar and number stays the same.

Speed Source Information

Select **Options > Installation**, select the name of the stereo, then select **Zones > Speed Vs Volume > Speed Source**.

Engine Speed: Uses the RPM reading provided by a supported NMEA 2000® engine. The volume increases as the engine RPM increases from the set Minimum speed to the set Maximum speed. If multiple supported engines are connected, the stereo uses the average RPM reading from all engines.

Speed Over Ground: Uses the speed over ground (SOG) reading provided by a supported NMEA 2000 GPS antenna or chartplotter with an internal GPS antenna. The volume increases as the SOG increases from the set Minimum speed to the set Maximum speed.

Speed Through Water: Uses the speed through water (STW) reading provided by a supported NMEA 2000 water-speed sensor. The volume increases as the STW increases from the set Minimum speed to the set Maximum speed.

Wind Speed: Uses the wind speed reading provided by a supported NMEA 2000 wind-speed sensor. The volume increases as the wind speed increases from the set Minimum speed to the set Maximum speed.

Stereo Zones and Groups

The Zones button appears only for stereos that support multiple speaker zones.

The Groups option appears only when you have multiple Fusion® stereos connected to one another using Fusion PartyBus™ networking.

If a connected stereo is set up to support multiple speaker zones, you can control the audio of the zones individually from the media screen on the chartplotter. For example, you could make the audio quieter in the cabin and louder on the deck ([Adjusting the Zone Volume, page 171](#)).

If you have multiple Fusion stereos connected to one another using Fusion PartyBus networking, you can create stereo groups and control the networked stereos and groups using the chartplotter.

Depending on the capabilities of the stereo or stereos connected to the chartplotter, you may have multiple options for controlling zone audio:

- For third-party stereos and compatible Fusion stereos, the Local Zones tab allow you to adjust the volume for all of the enabled speaker zones on the connected stereo.
- For multiple Fusion stereos connected to one another using Fusion PartyBus networking, the Group Zones tab allows you to adjust the volume for any zones on a stereo in the same group as Home Zone.
- For multiple Fusion stereos connected to one another using Fusion PartyBus networking, the Network tab allows you to adjust the volume for any zone on any stereo connected to the Fusion PartyBus network.

Selecting the Home Zone

If you have multiple stereos connected to the chartplotter, or have a stereo or stereos with multiple speaker zones connected to the chartplotter, you must designate one speaker zone on one stereo as the home zone. The playback and volume controls on the media screen adjust only the stereo or zone set as the home zone. The playback information on the media screen shows the source playing on the Home Zone stereo.

It is recommended to set the home zone as the zone closest to the chartplotter.



NOTE: Some stereos may feature a global zone. Setting a global zone as the home zone allows the controls on the media page to affect all of the zones on a stereo or media device.

The Zones button only appears for stereos or media devices that support multiple media zones.

- 1 From the media screen, select **Options > Home Zone**.
- 2 If necessary, select a connected stereo.
- 3 Select the zone you want to set as the **Home Zone**.
The name of the selected home zone appears on the media screen.

Adjusting the Zone Volume

The Zones button appears only for stereos that support multiple speaker zones.

- 1 From the media screen, select **Zones**.
A list of available zones appears.
- 2 If necessary, change the zone group to view the zone you want to adjust ([Stereo Zones and Groups, page 171](#)).
- 3 Select - and + to adjust the volume for a zone.

Disabling a Speaker Zone

If your connected media device features speaker zones, you can disable unused zones.

- 1 From the media screen, select **Options > Installation**.
- 2 Select a connected stereo.
- 3 Select **Zones**.
- 4 Select the zone you want to disable.
- 5 Select **Enable**.
The green bar on the button turns gray to indicate that the zone is disabled. You can select Enable to enable a disabled zone.

Creating a Group

If you have multiple Fusion® stereos connected to each other using Fusion PartyBus™ networking, you can create stereo groups and control the networked stereos and groups using the chartplotter. One stereo must be connected to the chartplotter through the NMEA 2000® network.

See the installation instructions and owner's manual provided with your compatible Fusion stereo for full information about how to install and configure a Fusion PartyBus network.

There are some limitations when streaming sources on the Fusion PartyBus network. See the owner's manual for your Fusion stereo for more information.

- 1 From the media screen, select **Options > Groups**.
- 2 Select the name of the stereo you want to be the primary stereo in the group, and select **Set as Source**.
- 3 Select the stereos you want to include in the group.
- 4 Select **Done**.

Editing a Group

- 1 From the media screen, select **Options > Groups**.
- 2 Select the name of an existing group.
- 3 Select the stereos you want to add to or remove from the group.
- 4 Select **Done**.

Group Synchronization

By default, groups you create are not maintained when you turn off stereos in the group. If you turn off a single stereo added to the group, it leaves the group. If you turn off the primary stereo in the group, the group is dissolved. You can enable group synchronization to preserve group membership for a stereo after turning it off. Group synchronization behaves differently based on how you turn the stereos off and on.

- If you turn a synchronized stereo off and on by using either the power button on the stereo or a physical switch on the ignition wire (the red wire), all of the synchronized stereos in the group turn off and on together. This applies to all of the synchronized stereos in the group, whether or not a stereo is the primary stereo in the group.
NOTE: Selecting ALL OFF from the power menu on a stereo turns off all stereos on the network, even if they are not in a group or have group synchronization enabled.
- If you turn a synchronized stereo off and on using a physical switch on the power wire (the yellow wire), the other synchronized stereos in the group behave differently:
 - If the synchronized stereo is the primary stereo in the group and you turn it off using a physical switch on the power wire, the other synchronized stereos in the group remain on, but leave the group. When you turn the primary stereo back on again, the other synchronized stereos rejoin the group.
 - If the synchronized stereo is not the primary stereo in the group and you turn it off and on using a physical switch on the power wire, all of the other synchronized stereos in the group remain on and grouped, and the stereo rejoins the group when you turn it on again.

Enabling Group Synchronization

You must remove the stereo from an existing group before you can enable the Save Group setting. You cannot update settings when a stereo is part of a group.

You must enable this setting on each stereo that you want to retain group settings after a power cycle.

- 1 From the **Media** screen, select **Options > Installation**.
- 2 Select the name of the stereo.
- 3 Select **Power Options > Save Group**.
The stereo retains group settings after a power cycle.
- 4 Repeat for additional stereos as needed.

NOTE: You must enable Save Group on all networked stereos for synchronization to work properly.

Playing Music

Browsing for Music

You can browse for music in some media sources.

- 1 From the media screen and an applicable source, select the button with the source name, such as **USB**.
- 2 Browse for, and select an item to play.

Enabling Alphabetical Search

You can enable the alphabetical search feature to find a song or album in a large list.

- 1 From the media screen, select **Options > Installation**.
- 2 Select the device.
- 3 Select **Alpha Search**.
- 4 Select the maximum number of tracks to appear in the search results.

To disable the alphabetical search feature, select Alpha Searching Off.

Setting a Song to Repeat

1 From the media screen while a song is playing, select an option.

- Select **Options** > **Repeat**.
- Select **Options** > **Browse** > **Repeat**.

2 If necessary, select **Single**.

Not all media devices and sources support the Single option for the Repeat control.

Setting All Songs to Repeat

Not all media devices and sources support the All option for the Repeat control.

From the media screen, select an option:

- Select **Options** > **Repeat** > **All**.
- Select **Options** > **Browse** > **Repeat** > **All**.

Setting Songs to Shuffle

From the media screen, select an option:

- Select **Options** > **Shuffle**.
- Select **Options** > **Browse** > **Shuffle**.

Radio

To listen to AM or FM radio, you must have a suitable marine AM/FM antenna properly connected to the stereo and be within range of a broadcasting station. For instructions on connecting an AM/FM antenna, see the stereo installation instructions.

To listen to SiriusXM® radio, you must have the appropriate equipment and subscriptions ([SiriusXM® Satellite Radio, page 175](#)). For instructions on connecting a SiriusXM Connect Vehicle Tuner, see the stereo installation instructions.

To listen to DAB stations, you must have a DAB-compatible stereo connected the chartplotter with the appropriate DAB equipment connected to the stereo ([DAB Playback, page 174](#)). For instructions on connecting a DAB antenna (and adapter, if necessary), see the installation instructions provided with your stereo, antenna, and adapter.

Setting the Tuner Region

1 From the media screen, select **Options** > **Installation** > **Tuner Region**.

2 Select an option.

Changing the Radio Station

1 From the media screen, select an applicable source, such as **FM**.

2 Select **◀** or **▶** to tune to a station.

Changing the Tuning Mode

You can change how you select a station for some media types, such as FM or AM radio.

NOTE: Not all tuning modes are available for all media sources.

Press the button between the **◀** and **▶** buttons to cycle between the tuning modes:

- To select a station manually, select **MANUAL**.
- To scan or stop on the next available station, select **AUTO**.
- To select a saved station preset, select **FAVORITE**.
- To select a category in some media sources, select **CATEGORY**.

Presets

You can save your favorite AM stations and FM stations as presets for easy access.

You can save your favorite SiriusXM® channels if the stereo is connected to an optional SiriusXM tuner and antenna.

You can save your favorite DAB stations if you have a DAB-compatible stereo connected the chartplotter with the appropriate DAB equipment connected to the stereo ([DAB Playback, page 174](#))

Saving a Station as a Preset

1 From an applicable media screen, tune to the station to save as a preset.

- 2 Select **Favorites > Add Current Channel**.

Selecting a Preset

- 1 From an applicable media screen, select **Favorites**.
- 2 Select a preset from the list.
- 3 Select **Tune to Channel**.

Removing a Preset

- 1 From an applicable media screen, select **Favorites**.
- 2 Select a preset from the list.
- 3 Select **Remove Current Channel**.

DAB Playback

When you connect a compatible Digital Audio Broadcasting (DAB) module and antenna, such as the Fusion® MS-DAB100A to a compatible stereo, you can tune in to and play DAB stations

To use the DAB source, you must be in a region in which DAB is available, and select the tuner region ([Setting the DAB Tuner Region, page 174](#)).

Setting the DAB Tuner Region

You must select the region you are in to receive DAB stations properly.

- 1 From the media screen, select **Options > Installation > Tuner Region**.
- 2 Select the region you are in.

Scanning for DAB Stations

- 1 Select the **DAB** source.
- 2 Select **Scan** to scan for available DAB stations.

When scanning is complete, the first available station in the first ensemble found begins playing.

NOTE: After the first scan is complete, you can select Scan again to re-scan for DAB stations. When the re-scan is complete, the system starts playing the first station in the ensemble you were listening to when you started the re-scan.

Changing DAB Stations

- 1 Select the **DAB** source.
- 2 If necessary, select **Scan** to scan for local DAB stations.
- 3 Select **◀** or **▶** to change the station.

When you reach the end of the current ensemble, the stereo automatically changes to the first available station in the next ensemble.

TIP: You can hold **◀** or **▶** to change the ensemble.

Selecting a DAB Station from a List

- 1 From the DAB media screen, select **Browse > Stations**.
- 2 Select a station from the list.

Selecting a DAB Station from a Category

- 1 From the DAB media screen, select **Browse > Categories**.
- 2 Select a category from the list.
- 3 Select a station from the list.

DAB Presets

You can save your favorite DAB stations as presets for easy access.

You can save up to 15 DAB-station presets.

Saving a DAB Station as a Preset

- 1 From the DAB media screen, select the station to save as a preset.
- 2 Select **Browse > Favorites > Save Current**.

Selecting a DAB Preset from a List

- 1 From the DAB media screen, select **Browse > Favorites > View Presets**.
- 2 Select a preset from the list.

Removing DAB Presets

- 1 From the DAB media screen, select **Browse > Favorites**.
- 2 Select an option:
 - To remove one preset, select **Remove Preset**, and select the preset.
 - To remove all presets, select **Remove All Presets**.

SiriusXM® Satellite Radio

When you have a compatible Fusion® stereo and SiriusXM Connect Tuner installed and connected to the chartplotter, you may have access to SiriusXM satellite radio, depending on your subscription.

Locating a SiriusXM® Radio ID

Before you can activate your SiriusXM subscription, you must have the radio ID of your SiriusXM Connect Tuner. You can locate the SiriusXM Radio ID on the back of the SiriusXM Connect Tuner, on the back of its packaging, or by tuning your chartplotter to channel 0.

- 1 Select **Media > Source > SiriusXM**.
- 2 Tune to channel 0.

The SiriusXM radio ID does not include the letters I, O, S, or F.

Activating a SiriusXM® Subscription

- 1 With the SiriusXM source selected, tune to channel 1.

You should be able to hear the preview channel. If not, check the SiriusXM Connect Tuner and antenna installation and connections, and try again.
- 2 Tune to channel 0 to locate the Radio ID.
- 3 Contact SiriusXM listener care by phone at (866) 635-2349 or go to siriusxm.com/activatenow to subscribe in the United States.
- 4 Provide the Radio ID.

The activation process usually takes 10 to 15 minutes, but can take up to an hour. For the SiriusXM Connect Tuner to receive the activation message, it must be turned on and receiving the SiriusXM signal.
- 5 If the service is not activated within the hour, go to <http://care.siriusxm.com/refresh> or contact SiriusXM Listener Care by phone at 1-866-635-2349.

Customizing the Channel Guide

SiriusXM® radio channels are grouped in categories. You can select the categories of channels that appear in the channel guide.

Select an option:

- If the media device is a compatible Fusion® stereo, select **Media > Browse > Channel**.
- If the media device is a GXM™ antenna, select **Media > Category**.

Saving a SiriusXM® Channel to the Presets List

You can save your favorite channels to the presets list.

- 1 Select **Media**.
- 2 Select the channel to save as a preset.
- 3 Select an option:
 - If the media device is a compatible Fusion® stereo, select **Browse > Favorites**.
 - If the media device is a GXM™ antenna, select **Options > Favorites > Add Current Channel**.

Parental Controls

The parental control feature allows you to limit access to any SiriusXM channels, including those with mature content. When the parental control feature is enabled, you must enter a passcode to tune to the locked channels. You can also change the 4-digit passcode.

Unlocking SiriusXM® Parental Controls

- 1 From the media screen, select **Browse > Parental > Unlock**.
- 2 Enter your passcode.

The default passcode is 0000.

Setting Parental Controls on SiriusXM® Radio Channels



Before you can set parental controls, the parental controls must be unlocked.

The parental control feature allows you to limit access to any SiriusXM channels, including those with mature content. When enabled, the parental control feature requires you to enter a passcode to tune to the locked channels.

Select **Browse > Parental > Lock/Unlock**.

A list of channels appears. A checkmark indicates a locked channel.

NOTE: When you view the channels after setting parental controls, the display changes:

-  indicates a locked channel.
-  indicates an unlocked channel.

Clearing All Locked Channels on a SiriusXM® Radio

Before you can clear all locked channels, the parental controls must be unlocked.

1 From the media screen, select **Browse > Parental > Clear All Locked**.

2 Enter your passcode.

Restoring Default Parental Control Settings Values

This process deletes all the settings information you have entered. When you restore the parental control settings to their default values, the passcode value is reset to 0000.

1 From the media menu, select **Installation > Factory Defaults**.

2 Select **Yes**.

Changing a Parental Passcode on a SiriusXM® Radio

Before you can change the passcode, the parental controls must be unlocked.

1 From the media screen, select **Browse > Parental > Change PIN**.

2 Enter your passcode and select **Done**.

3 Enter a new passcode.

4 Confirm the new passcode.

Setting the Device Name

1 From the media screen, select **Options > Installation > Set Device Name**.

2 Enter a device name.

3 Select **Select** or **Done**.

Updating the Media Player Software

You can update the software on compatible connected stereos and accessories.

See the stereo *Owner's Manual* at support.garmin.com for instructions on updating the software.

Audio Return Channel

The HDMI® Audio Return Channel (ARC) enables you to play the audio from the chartplotter over the stereo system speakers and play HDMI audio on the chartplotter using only one HDMI cable.

ARC eliminates the need to connect a separate audio cable from the chartplotter to the stereo. Typically, in systems without ARC, to play the audio from the chartplotter over the stereo system speakers, you would need a separate cable.

The HDMI version 1.4 cables support ARC. When planning your stereo installation, you should check whether your devices support ARC. Most devices that support ARC have an ARC label on the HDMI connector that supports ARC.

NOTE: The Fusion® MS-RA800 stereo supports ARC. You should update the stereo to use ARC with the chartplotter.

Configuring a Stereo from the Chartplotter

You can configure various features of a compatible connected stereo using the chartplotter.

- 1 From the **Media** screen, select **Options > Installation**.
- 2 Select the name of the stereo.
- 3 Select a setting to configure.

NOTE: See the latest *Owner's Manual* for the stereo for more information about the settings you can configure.

SiriusXM® Weather

WARNING

The weather information provided through this product is subject to service interruptions and may contain errors, inaccuracies, or outdated information, and consequently should not be relied upon exclusively. Always use common sense while navigating, and check alternate weather information sources prior to making safety-related decisions. You acknowledge and agree that you shall be solely responsible for use of the weather information and all decisions taken with respect to navigating in weather. Garmin® will not be responsible for any consequences of using SiriusXM weather information.

NOTE: SiriusXM data is not available in all regions.

A Garmin SiriusXM satellite weather receiver and antenna receives satellite weather data and shows it on various Garmin devices, including the Navigation chart on a compatible chartplotter. The weather data for each feature comes from reputable weather data centers such as the National Weather Service and the Hydrometeorological Prediction Center. For more information, go to www.siriusxm.com/sxmmarine.

SiriusXM® Equipment and Subscription Requirements

To use satellite weather, you must have a compatible satellite weather receiver. To use SiriusXM satellite radio, you must have a compatible satellite radio receiver. Go to www.garmin.com for more information. You must also have a valid subscription to receive satellite weather and radio. For more information, refer to the instructions for your satellite weather and radio equipment.

Weather Data Broadcasts

Weather data is broadcast at different intervals for each weather feature. For example, radar is broadcast at five-minute intervals. When the Garmin® receiver is turned on, or when a different weather feature is selected, the receiver must receive new data before it can be shown. You might experience a delay before weather data or a different feature appears on the chart.

NOTE: Any weather feature can change in appearance if the source that provides the information changes.

Weather Warnings and Weather Bulletins

When a marine weather warning, weather watch, weather advisory, weather bulletin, or other weather statement is issued, shading indicates the area to which the information applies. The aqua lines on the chart indicate the boundaries of marine forecasts, coastal forecasts, and offshore forecasts. Weather bulletins may consist of either weather watches or weather advisories.

To view information about the warning or bulletin, select the shaded area.

Color	Marine Weather Group
Cyan	Flash Flood
Blue	Flood
Red	Marine
Yellow	Severe Storm
Red	Tornado

Viewing Precipitation Information

Precipitation ranging from very light rain and snow, up to strong thunderstorms, is indicated in varying shades and colors. Precipitation is shown either independently or with other weather information.

Select **Charts > Precipitation**.

The time stamp in the upper-left corner of the screen indicates the elapsed time since the weather data provider last updated the information.

Storm Cell and Lightning Information

Storm cells are represented by the  icon on the weather precipitation chart. They indicate both the present position of a storm and the projected path of that storm in the immediate future.

Red cones appear with a storm cell icon, and the widest part of each cone points in the direction of the projected path of the storm cell. The red lines in each cone indicate where the storm will most likely be in the near future. Each line represents 15 minutes.

Lightning strikes are represented by the  icon. Lightning appears on the weather precipitation chart if strikes were detected within the last seven minutes. The ground-based lightning detection network detects cloud-to-ground lightning only.

NOTE: This feature is not available on all devices and in all subscriptions.

Hurricane Information

The weather Precipitation chart can show the present position of a hurricane , a tropical storm, or a tropical depression. A red line stemming from a hurricane icon indicates the projected path of the hurricane. Darkened dots on the red line indicate the projected locations through which the hurricane will pass, as received from the weather data provider.



Forecast Information

The Forecast chart shows city forecasts, marine forecasts, warnings, hurricane warnings, METARS, county warnings, weather fronts and pressure centers, surface pressure, and weather buoys.

Viewing a Marine Forecast or an Offshore Forecast





- 1 Select **Charts > Forecast**.
- 2 Pan the chart to an offshore location.
The Marine Forecast or Offshore Forecast options appear when forecast information is available.
- 3 Select **Marine Forecast** or **Offshore Forecast**.

Viewing Forecast Information for Another Time Period

- 1 Select **Charts > Forecast**.
- 2 Select an option:
 - To view the weather forecast for the next 48 hours, in 12-hour increments, select  multiple times.
 - To view the weather forecast for the previous 48 hours, in 12-hour increments, select  multiple times.

Weather Fronts and Pressure Centers

Weather fronts appear as lines that indicate the leading edge of an air mass.







Front Symbol	Description
	Cold front
	Warm front
	Stationary front
	Occluded front
	Trough



Pressure-center symbols often appear near weather fronts.

Pressure-Center Symbol	Description
L	Indicates a low-pressure center, which is a region of relatively lower pressure. Moving away from a low-pressure center results in increased pressure. Winds flow counterclockwise around low-pressure centers in the northern hemisphere.
H	Indicates a high-pressure center, which is a region of relatively higher pressure. Moving away from a high-pressure center results in decreased pressure. Winds flow clockwise around high-pressure centers in the northern hemisphere.

City Forecasts

City forecasts appear as weather symbols. The forecast is viewed in 12-hour increments.

Symbol	Weather
	Fair (sunny, hot, clear)
	Partly cloudy
	Cloudy
	Rain (drizzle, sleet, showers)
	Thunderstorms
	Windy

Symbol	Weather
	Smoke (dusty, hazy)
	Foggy
	Snow (snow showers, flurries, blizzard, blowing snow, sleet, freezing rain, freezing drizzle)

Viewing Fish Mapping Data

NOTE: This feature requires a GXM™ 54 antenna and a SiriusXM® Fish Mapping™ service subscription. The Fish Mapping weather chart shows information that can help you locate fish species.

- 1 Select **Charts > Fish Mapping**.
- 2 If necessary, select **Options > Layers**, and turn on and off information.







Viewing Sea Conditions

The Sea Conditions feature shows information about surface conditions, including winds, wave height, wave period, and wave direction.

Select **Charts > Sea Conditions**.

Surface Winds

Surface wind vectors appear on the Sea Conditions chart using wind barbs that indicate the direction from which the wind is blowing. A wind barb is a circle with a tail. The line or flag attached to the tail of the wind barb indicates the wind speed. A short line represents 5 knots, a long line represents 10 knots, and triangle represents 50 knots.

Wind Barb	Wind Speed
	Calm
	5 knots
	10 knots
	15 knots
	20 knots
	50 knots
	65 knots



Wave Height, Wave Period, and Wave Direction

Wave heights for an area appear as variations in color. Different colors indicate different wave heights, as shown in the legend.

The wave period indicates the time (in seconds) between successive waves. Wave period lines indicate areas that have the same wave period.

Wave directions appear on the chart using red arrows. The direction of each arrow pointer indicates the direction in which a wave is moving.

Viewing Forecast Sea Conditions Information for Another Time Period

- 1 Select **Charts > Sea Conditions**.
- 2 Select an option:
 - To view forecasted sea conditions for the next 36 hours, in 12-hour increments, select  multiple times.
 - To view the forecasted sea conditions for the previous 36 hours, in 12-hour increments, select  multiple times.

Viewing Sea Temperature Information

The Sea Temperature weather chart shows the present water temperature and present surface pressure conditions.

Select **Charts > Sea Temperature**.

Surface Pressure and Water Temperature Data

Surface-pressure information appears as pressure isobars and pressure centers. Isobars connect points of equal pressure. Pressure readings can help to determine weather and wind conditions. High-pressure areas are

generally associated with fair weather. Low-pressure areas are generally associated with clouds and the chance of precipitation. Isobars packed closely together show a strong pressure gradient. Strong pressure gradients are associated with areas of stronger winds.

Pressure units are shown in millibars (mb), inches of Mercury (inHg), or hectopascals (hPa).

Colored shading indicates the surface temperature of the water, as shown in the legend in the corner of the display.

Changing the Sea Surface Temperature Color Range

You can change the color range dynamically to view higher resolution sea surface temperature readings.

- 1 Select **Charts > Sea Temperature > Options > Sea Temperature**.
- 2 Select an option:
 - To allow the chartplotter to adjust the temperature range automatically, select **Auto Configure**.
The chartplotter automatically finds the lower and upper limits for the current screen, and updates the temperature-color scale.
 - To enter the lower and upper limits for the temperature range, select **Lower Limit** or **Upper Limit**, and enter the lower or upper limit.



Visibility Information

Visibility is the forecast maximum horizontal distance that can be seen at the surface, as shown in the legend on the left of the screen. Variations in the visibility shading show the forecast change in surface visibility.

NOTE: This feature is not available on all devices and in all subscriptions.

Select **Charts > Visibility**.

Viewing Forecast Visibility Information for Another Time Period

- 1 Select **Charts > Visibility**.
- 2 Select an option:
 - To view the visibility forecast for the next 36 hours, in 12-hour increments, select  multiple times.
 - To view the visibility forecast for the previous 36 hours, in 12-hour increments, select  multiple times.

Viewing Buoy Reports

Report readings are taken from buoys and coastal observation stations. These readings are used to determine air temperature, dew point, water temperature, tide, wave height and period, wind direction and speed, visibility, and barometric pressure.

- 1 From a weather chart, select a  buoy icon.
- 2 Select **Buoy**.

Viewing Local Weather Information near a Buoy

You can select an area near a buoy to view forecast information.

- 1 From a weather chart, select a location on the chart.
- 2 Select **Local Weather**.
- 3 Select an option:
 - To view present weather conditions from a local weather service, select **Current Condition**.
 - To view a local weather forecast, select **Forecast**.
 - To view surface wind and barometric pressure information, select **Sea Surface**.
 - To view wind and wave information, select **Marine Bulletin**.

Weather Overlay

The weather overlay superimposes weather and weather-related information on the Navigation chart, the Fishing chart, and the Perspective 3D chart view. The Navigation chart and the Fishing chart can show weather radar, height of cloud tops, lightning, weather buoys, county warnings, and hurricane warnings. The Perspective 3D chart view can show weather radar.

Weather overlay settings configured for use on one chart are not applied to another chart. The weather overlay settings for each chart must be configured separately.

NOTE: The Fishing chart is available with premium charts, in some areas.

Viewing Weather Subscription Information

You can view information about the weather services you have subscribed to and how many minutes have passed since the data for each service was updated.

From a weather chart, select **Options** > **Subscription**.

Viewing Video

WARNING

Do not view video or photos while operating the vessel. Failure to pay attention to the conditions on the water can result in vessel damage, personal injury, or death.

Before you can view video, you must connect to a compatible source.

Compatible sources include video devices connected to the ports on the chartplotter and supported network (IP-based) video cameras and thermal cameras connected to the Garmin® network.

Protected HDMI® content, HDCP, cannot be shared across the Garmin network to GPSMAP® 8000 series or older chartplotters. HDCP content can be shared by a GPSMAP 9000 series chartplotter only to other GPSMAP 9000 series chartplotters connected to the Garmin BlueNet™ network.

1 From the home screen, select **Video**.

All connected video sources are shown.

2 Select the video source you would like to view.

NOTE: If you recently connected a video source and the system did not automatically assign a source type, you must first assign it a source type before you can view the video feed ([Video Source Types, page 183](#)).

Video Source Considerations

When connecting video sources to the system and viewing them on a chartplotter screen, observe these considerations.

- Up to 32 unique video sources can be connected and shown on the Video tab.

TIP: If you add a video source beyond the limit of 32, you can still access the new source by creating a combo and adding it to one of the windows ([Creating a New Combination Page, page 24](#)).

- If the system does not automatically assign a source type to a connected video source, you must first assign it a source type before you can view the video feed.
- If you disconnect a video source from the system, a placeholder remains on the Video tab. You can access the source again after reconnecting it to the system.

Video Source Types

Various video sources connected to the chartplotter or network are assigned a source type that defines the type of video provided and how the input is handled by the system. You can configure video sources to adjust the type if needed.

Source Type	Details
Camera	The connected video source is a CVBS or IP camera.
Entertainment	The connected video source is an HDMI entertainment device, such as a media streaming stick. Audio and video from an Entertainment device can be synchronized with other chartplotters connected to the Garmin BlueNet™ network. NOTE: Audio and video from an Entertainment device are not synchronized with chartplotters connected to a legacy Garmin® Marine Network.
Monitor	The connected video source is a device using the chartplotter as a monitor, such as a PC. This type provides the lowest possible latency.
Not Selected	The connected video source has not been assigned a specific type. This source acts as Monitor type until it is changed to a different type.

Changing the Video Source Name and Type

If the system assigned an incorrect type to a connected video source, or you would prefer for a source to behave as a different type, you can change it. You can also change the name associated with the video source.

1 Select  > **My Vessel** > **Video** > **Source List**.

2 Select the video source you want to change and select **Review**.

3 Select an option:

- To change the type associated with the source, select **Source Type** and select a type.
- To change the name associated with the source, select **Name** and enter a name.

Networked Video Devices

NOTICE

A Garmin® Power over Ethernet (PoE) Isolation Coupler (P/N 010-10580-10) must be used when connecting third-party and PoE cameras, such as FLIR® cameras, to legacy Garmin Marine Network devices. Connecting a third-party camera directly to a legacy Garmin Marine Network chartplotter damages the Garmin chartplotter and may damage the camera.

This isolation coupler is not needed when connecting a third-party camera to a Garmin BlueNet™ network.

In some jurisdictions it could be considered an invasion of privacy rights to take or publicly display photographs or videos of people without their permission. It is your responsibility to know and comply with privacy laws and rights within the applicable jurisdiction(s).

Before you can view and control video devices such as IP cameras and thermal cameras using your chartplotter, you must have a compatible video device connected to your chartplotter. When connecting a PoE camera to a Garmin Marine Network, you must install a Garmin Marine Network PoE isolation coupler. When connecting a PoE camera to a Garmin BlueNet network, the isolation coupler is not necessary. Go to garmin.com for a list of compatible devices or to purchase a PoE Isolation Coupler. Go to garmin.com/manuals/bluenet for more information about Garmin BlueNet technology.

You can connect multiple supported video cameras to the Garmin network. You can select and view up to four video sources at once. When the cameras are connected, the network detects them automatically and displays them in the source list.

Using Video Presets on Networked Video Cameras

You can save, name, and activate video presets for each networked video source.

Saving Video Presets on a Networked Video Camera

- 1 From a video screen, touch the screen.
The video controls appear on the screen.
- 2 Hold a video preset button.
A green light indicates the setting is stored.

Naming Video Presets on a Networked Video Camera

- 1 From a video screen, select **Options > Video Setup > Favorites**.
- 2 Select a preset.
- 3 Select **Rename**.
- 4 Enter preset name.

Activating Video Presets on a Networked Video Camera

You can quickly return networked cameras to preset values.

- 1 From a video screen, touch the screen.
The video controls appear on the screen.
 - 2 Select a video preset.
The camera restores the video settings saved for that preset.
- TIP:** You can also save and activate presets using the video menu.

Camera Settings

Some cameras provide additional options to control the camera view.

Not all options are available on all camera models and chartplotter models. Refer to the camera manual for a list of available features. You may need to update the camera software to use this feature.

From the infrared video screen, select Options.

IR Blend: Selects the infrared effect to MSX® (Multi-Spectral Dynamic Imaging) mode or CTV (Color Thermal Vision™) mode, and allows you to blend the effects.

IR/Visible: Displays an infrared or visible light image.

Scan: Surveys the surrounding area.

Freeze: Pauses the camera image.

Change Colors: Selects the color scheme of the infrared image.

Change Scene: Selects the infrared image mode, such as day, night, MOB, or docking.

Video Setup: Opens more video options.

Video Settings

Some cameras provide additional setup options.

Not all options are available on all camera models and chartplotter models. You may need to update the camera software to use this feature.

From the video screen, select **Options > Video Setup**.

Set Input: Associates the camera with a video source.

Mirror: Reverses the image like a rearview mirror.

Standby: Places the camera in standby mode to conserve power and protect the lens when not in use.

Home Position: Sets the home position of the camera.

Scan Speed: Sets how quickly the camera moves during a scan.

Scan Width: Sets the width of the image captured by the camera during a scan.

Stabilization: Stabilizes the picture using mechanical means.

Low Light: Optimizes the video for low-light environments.

Aspect: Sets the aspect ratio.

Defog: Optimizes the video for foggy environments.

Dynamic Range: Sets the range to wide or standard.

E. Stabilization: Stabilizes the picture using software image processing.

Light: Controls the camera's integrated light source to help illuminate the environment.

Name: Allows you to enter a new name for this camera.

FLIR™ Menu: Provides access to the settings for the camera.

Video Camera Movement Control

NOTICE

Do not aim the camera at the sun or extremely bright objects. Damage to the lens may occur.

Always use the chartplotter controls or buttons to pan and tilt the camera. Do not manually move the camera unit. Manually moving the camera may damage the camera.

NOTE: This feature is available only when a compatible camera is connected. You may need to update the camera software to use this feature.

You can control the movements of the connected video cameras that support panning, tilting, and zooming.

Controlling Video Cameras Using On-Screen Controls

On-screen controls allow you to control pan-tilt-zoom (PTZ) cameras. Refer to the camera manual for a list of available features.

- 1 From a video screen, touch the screen.
The video controls appear on the screen.
- 2 Select an option:
 - To zoom in and out, use the zoom button.
 - To pan or tilt the camera, use the compass rose.

TIP: Hold within the compass rose to continue to move the camera in the desired direction.

Controlling a Video Camera Using Gestures

When a networked video camera supports gesture responses, you can control pan-tilt-zoom cameras using gestures directly on the chartplotter screen. Check your camera user manual for a list of available features.

TIP: Using gestures allows video control without displaying the video controls.

- 1 From a video screen, touch the screen.
- 2 Select an option:
 - To zoom in and out with the camera, use pinch and zoom gestures.
 - To pan or tilt the camera, swipe the screen in the desired direction.

Configuring the Video Appearance

Not all options are available on all camera models and chartplotter models.

- 1 From the video screen, select **Options > Video Setup**.
- 2 Select an option:

- To show the video using a stretched aspect ratio, select **Aspect > Stretch**. The video cannot be stretched beyond the dimensions provided by the connected video device, and it may not fill the entire screen.
- To show the video using a standard aspect ratio, select **Aspect > Standard**.
- To adjust the brightness, select **Brightness**, and select **Up, Down, or Auto**.
- To adjust the color saturation, select **Saturation**, and select **Up, Down, or Auto**.
- To adjust the contrast, select **Contrast**, and select **Up, Down, or Auto**.
- To allow the chartplotter to automatically select the source format, select **Standard > Auto**.

Changing the Camera View

When using a compatible camera, such as a GC™ 245/255, you can change the appearance of the camera view.

- 1 From a video screen, select **Options**.
- 2 Select **Camera View** and select an option:
 - For a typical camera view, select **Standard**.
 - For a wide-angle view with slight circular distortions, select **Fish Eye**.
NOTE: Distance markers or guidance lines are not available when using the **Fish Eye** camera view.
 - For an overhead view of the vessel, select **Bird's Eye**
NOTE: The bird's-eye view is available only if your camera was installed by your boat builder and if they properly calibrated the system. Distance markers are available when using the bird's-eye view, but guidance lines are not.

Mirroring or Rotating the Camera Image

When using a compatible camera, such as a GC™ 245/255, you can change the camera image to better fit the mounting orientation.

- 1 From a compatible video screen, select **Options**.
- 2 Select an option:
 - To mirror the image, select **Video Setup > Mirror**.
 - To rotate the image by 180 degrees, select **Installation > Inverted Install**.
NOTE: If your camera was installed by your boat builder, inverted configuration may have already been set and cannot be changed.

Configuring Guidance Lines

When using a compatible camera, such as a GC™ 245/255, you can configure guidance lines to aid when docking your vessel.

NOTE: If your camera was installed by your boat builder, it may already be configured for the distance markers feature, which is different than the guidance lines feature. You can change this configuration to use guidance lines instead of distance markers by following these instructions.

⚠ CAUTION

Guidance lines are user-configured and intended for visual reference only. They may not prevent collisions in all circumstances and should not be relied upon for determining exact distances. It is your obligation to ensure safe operation of your vessel and to remain aware of your surroundings while operating your vessel.

- 1 From a compatible video screen, select **Options**.
- 2 Select an option:
 - If your camera supports distance markers, and you are enabling guidance lines for the first time, select **Video Setup > Enable Guidance Lines** to disable distance markers and configure guidance lines.
 - If your camera does not support distance markers, select **Video Setup > Adjust Guidance Lines**.
- 3 Select **Up, Down, Left** and **Right** to adjust the first reference point.
- 4 After you've set the first reference point, select **Next** to adjust the next point.
- 5 Repeat this process to set the other three points.
We recommend setting reference points so that the vertical lines align with the edge of a dock next to your vessel, and so that the red horizontal line is positioned just off the stern of your vessel.
- 6 After you've adjusted all of the reference points and have finished configuring the guidance lines, select **Back** to exit.

TIP: You can select Save as Default to save this configuration and recall it later by selecting Reset to Default.

Alternating Among Multiple Camera Sources

If you have two or more video sources categorized as cameras, you can alternate between them using a specific time interval. This action is not part of the camera layout in the Video tab of the home screen. You must create a custom combo to select the camera sources and time intervals.

NOTE: Only connected video sources categorized as a camera can be included as an alternating source. You cannot include an entertainment or monitor source.

- 1 From the home screen, select **Combo > Add Combo**.
- 2 Define the layout of the combo screen and tap a combo window to add the video sources.
- 3 Select **Camera > Alternate**.
- 4 Select **Time**, and select the amount of time each video appears.
- 5 Select **Source**, and select the video sources to add to the alternating sequence.

Camera Tracking

When connected to a compatible camera, you can use advanced camera-tracking features.

- Hold the camera on a fixed compass direction (Compass Lock)
- Lock the camera at a fixed angle relative to the vessel (Vessel Lock)
- Track AIS, MARPA, or waypoint targets (also known as slew-to-cue)

To use any of the camera tracking features, you must connect compatible sensors and cameras to the chartplotter using the Garmin BlueNet™ network, Garmin® Marine Network or the NMEA 2000® network.

To support Compass Lock and Vessel Lock functionality, you must connect these sensors and cameras:

- A tracking-capable marine camera, such as a newer model FLIR® IP video camera
- A GPS antenna
- A heading sensor

For the best camera tracking performance, the heading sensor should provide 9-axis data including yaw, pitch, and roll.

In addition to the sensors and cameras needed to support Compass Lock and Vessel Lock, you must connect these additional devices to the Garmin BlueNet network or the Garmin Marine Network to support AIS and MARPA tracking:

- To track targets using AIS, you must connect a compatible AIS receiver.
- To track targets using MARPA, you must connect a compatible radar device.

Setting the Camera Angle and Height

If the camera supports camera tracking and the required equipment is connected, you should configure the camera angle and height for the best results when using the camera tracking feature.

You should make small adjustments until the camera view and camera tracking performance work as expected.

- The Camera Angle value specifies the angle at which the front of the camera points relative to the front of the boat. A Camera Angle of zero degrees indicates the front of the camera is aligned with the front of the boat.
- The Camera Height value specifies how high the camera is mounted above the heading sensor.
- To set the camera angle, from a compatible video screen, select **Options > Installation > Camera Angle**, and enter a value.
- To set the camera height, from a compatible video screen, select **Options > Installation > Camera Height**, and enter a value.

Using Compass Lock

Your tracking-capable camera can lock onto a compass direction regardless of the vessel heading. Using Compass Lock requires specific sensors and devices (*Camera Tracking, page 187*).

- 1 From a compatible video screen, drag the screen to aim the camera in the desired direction.
- 2 Select **Options > Target Tracking > Compass Lock**.
- 3 Select **Back** until you return to the video screen.
The camera view automatically adjusts to show the specified direction as the vessel moves.
- 4 If necessary, drag the screen to adjust the camera angle.
The Compass Lock continues to track using the adjusted camera angle.
- 5 To stop tracking, select **Options > Target Tracking > Stop Tracking > Back**.

Using Vessel Lock

Your tracking-capable camera can lock on a target using information provided by other devices connected to the chartplotter. Depending on the target you want to track, using Vessel Lock requires specific equipment ([Camera Tracking](#), page 187).

- 1 From a compatible video screen, select **Options** > **Target Tracking** and select an option:
 - To track a vessel using AIS position information, select **AIS List**.
 - To track a vessel or target using MARPA information, select **MARPA List**.
 - To track a specific GPS coordinate location, select **Waypoints**
- 2 Select a target from the list, and select **Review**.
- 3 Verify the target details, and select **Track with Camera**.
- 4 Select **Back** until you return to the video screen.

The camera view automatically adjusts to show the selected vessel or target as either vessel moves.
- 5 If necessary, drag the screen to adjust the camera angle.

The Vessel Lock continues to track the vessel or target using the adjusted camera angle.
- 6 To stop tracking, select **Options** > **Target Tracking** > **Stop Tracking** > **Back**.

HDMI® Video Considerations

NOTICE

To prevent corrosion due to moisture, you must use Garmin® GPSMAP® accessory cables when connecting the chartplotter to the video source or display. Do not connect a media player stick directly into the back of the chartplotter. Using different cables or connecting a media player stick into the back of the chartplotter voids your warranty.

These chartplotter models allow video input from HDMI video sources, such as a Chromecast™ device or a Blu-Ray™ player.

You can view HDCP content on an external monitor that supports industry HDCP standards.

HDMI video is shared across the Garmin BlueNet™ network and across the Garmin Marine Network, but it is not shared across the NMEA 2000® network. HDCP content cannot be shared across the Garmin network to GPSMAP 8000 series or older chartplotters. HDCP content can be shared by a GPSMAP 9000 series chartplotter only to other GPSMAP 9000 series chartplotters connected to the Garmin BlueNet network.

The Garmin GPSMAP HDMI accessory cable is 4.5 m (15 ft) long. If you need a longer cable, you should use an active HDMI cable only. You need an HDMI coupler to connect the two HDMI cables.

You can use an adapter cable to power a media player stick using a USB port on the chartplotter. The USB DRD port can supply up to 2.5 W to power a media player stick. The USB port can supply up to 4.5 W to power a media player stick.

You must make all cable connections in a dry environment.

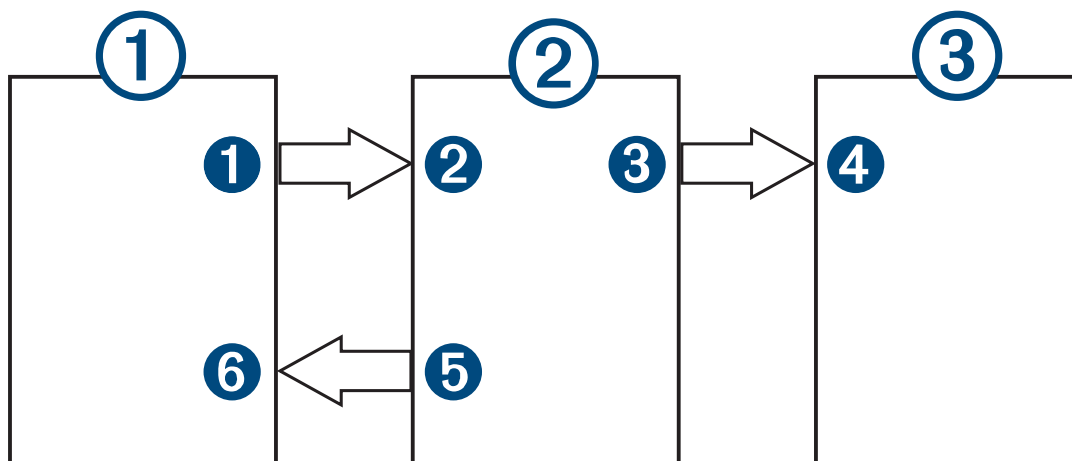

Devices



Item	Device
①	HDMI source, such as a Chromecast device
②	GPSMAP chartplotter
③	Monitor, such as a computer or television

Connections

From	To	Cable
① HDMI source's HDMI OUT port	② Chartplotter's HDMI IN port	Garmin HDMI Cable
③ Chartplotter's HDMI OUT port	④ Monitor's HDMI IN port	Garmin HDMI Cable
⑤ Chartplotter's USB DRD or USB port ⁵	⑥ HDMI source's USB port	Adapter cable to power the HDMI source, if possible (2.5 W or 4.5 W maximum depending on chartplotter model and USB port)

Controlling HDMI® Audio

You can control the audio for HDMI video sources.

- 1 From an HDMI video source, select **Options**.
- 2 Select an option:
 - To turn off the audio, select **Off**.
The  icon appears on the video screen.
 - To play the HDMI audio, select **On**.
The  icon appears on the video screen.
 - To always play the HDMI audio, even when you are not viewing the HDMI video, select **Always On**.
The  icon appears on the video screen.

Pairing the GC™ 100 Camera with a Garmin® Chartplotter

Before you can connect a wireless device to the chartplotter wireless network, you must configure the chartplotter Wi-Fi® network ([Setting Up the Wi-Fi® Network, page 37](#)).

NOTE: You may need to charge the camera's internal battery before you can pair it with a chartplotter. You can charge the internal battery through the camera's powered mount or, alternatively, you can connect the camera to a power source using a Micro-USB cable (not included). The Micro-USB port is located on the front of the camera, behind a protective cap.

- 1 With the camera within an unobstructed 76 m (250 ft.) of the chartplotter, press  three times.
The LED light will start flashing blue.
- 2 On the chartplotter, select **Settings > Communications > Wireless Devices > Garmin Camera > Start**.
The chartplotter will show a notification when it has paired with the camera.

⁵ GPSMAP 9000xsv chartplotters have only a USB DRD port, capable of providing a maximum output of 2.5 W.

Surround View Camera System

⚠ WARNING

Do not solely rely on this system for vessel docking and operation purposes.

Objects displayed by the cameras may be closer than they appear.

This system is only intended to enhance situational awareness when used properly. If used improperly, you could become distracted by the display. Failure to pay attention to your surroundings during vessel docking and operation could cause you to miss obstacles or hazards in or around the water, leading to an accident causing property damage, personal injury, or death.

The Surround View Camera System is a set of dedicated cameras installed and configured to provide a complete bird's-eye view of your vessel to easily see your immediate surroundings. You can also view video feeds from any of the dedicated cameras in the system to help with maneuvering and docking.

The Surround View Camera System is available only on select vessels and is installed by the boat builder.

To view the surround view camera screen, from the home screen, select **Vessel > Surround View**.

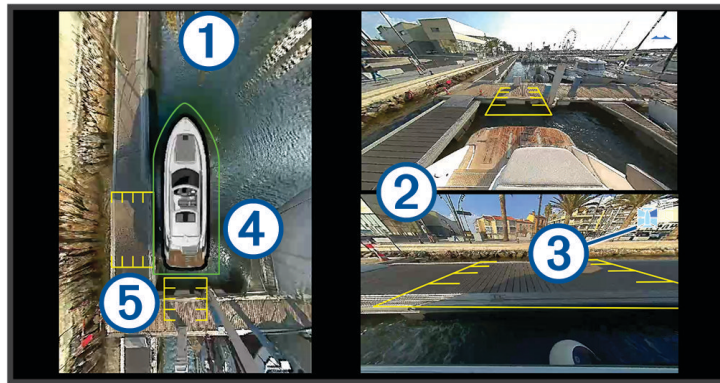

Item	Description	Information
①	Bird's eye	The bird's-eye view is always shown on the surround view camera screen. You can include the bird's-eye view as part of a combo with another screen, such as a chart.
②	Individual camera feeds	By default, two individual camera feeds are shown on the surround view screen. You can customize this to show only one camera instead. You can quickly change which cameras are shown in these feeds.
③	Selected camera indicator	This indicator shows which camera is shown in the individual camera feed.
④	Visual bumper	You can enable and configure the visual bumper to show a line on the birds-eye view that can help you judge how close objects are to your boat.
⑤	Distance marker	You can enable this feature to help judge distances when maneuvering or docking.

Changing a Camera

You can change which camera shows a live feed on the Surround View screen.

- 1 From the **Surround View** screen, touch the camera feed you want to change.
- 2 Touch  and touch the camera you want to view.

Viewing a Camera Feed Full Screen

You can switch to a full-screen view any of the live camera feeds.

NOTE: You can also view each of the cameras in the Surround View Camera System in the Video screen.

- 1 From the **Surround View** screen, select the camera you want to view full screen.
 - 2 Select .
- The camera switches to a full-screen view, and you can zoom and pan using the controls.

To return to the Surround View screen, select .

Changing the Surround View Camera System Layout

You can change the layout of the Surround View screen to show one or two separate camera feeds in addition to the bird's-eye view.

- 1 From the **Surround View** screen, select **Options > Layout**.
- 2 Select the layout.

Showing and Hiding the Visual Bumper

The visual bumper is an adjustable perimeter line you can set around your boat. The visual bumper appears on the birds-eye view only, and can help you judge how close objects are to your boat.

- 1 From the surround view camera screen, select **Options > Visual Bumper**.
- 2 Select an option
 - To show a standard visual bumper, select **On**
 - To show a visual bumper that detects objects and indicates potential collisions, select **Active** ([Object Detection and Proximity Alert, page 191](#)).

Adjusting the Visual Bumper

You must have the visual bumper shown on the bird's-eye view before you can adjust it.

- 1 From the surround view camera screen, select **Options > Visual Bumper > ⋮**.
- 2 Increase or decrease the range of the visual bumper line.
- 3 Select **Back**.

Showing the Distance Marker

You can show the distance marker to gain a better sense of distance when maneuvering or docking.

The distance markers shown on the bird's-eye view are determined by the cameras selected in the individual camera feeds.

- 1 From the surround view camera screen, select **Options > Distance Marker**.
- 2 Select an option
 - To show a standard distance marker, select **On**
 - To show a distance marker that detects objects and indicates potential collisions, select **Active** ([Object Detection and Proximity Alert, page 191](#)).

Surround View Camera Movement Control

You can use the chartplotter to control the movement of surround view cameras, including panning, tilting, and zooming ([Video Camera Movement Control, page 185](#)).

Renaming a Camera

You can change the name of any camera in the Surround View Camera System.

- 1 From the **Surround View** screen, select **Options > Rename Cameras**.
- 2 Select the camera you want to rename.
- 3 Enter a new name for the camera.
- 4 Select **Options > Rename CamerasDone**.

Setting the Camera to Mirrored Stern View

You can set the camera to display a mirrored stern view that displays the camera view as you would view it in a mirror, such as a rearview mirror. A mirrored stern view is useful when docking the vessel.

From the surround view camera screen, select **Options > Mirror Stern Camera**.

Object Detection and Proximity Alert

WARNING

You are responsible for the configuring the desired ranges for these features. Garmin does not confirm the efficacy of the ranges that you have selected.

Object detection and proximity alerts are tools for situational awareness only while docking your vessel and may not prevent collisions in all circumstances. You are responsible for the safe and prudent operation of your vessel, for remaining aware of your surroundings, and for using safe judgment on the water at all times.

These features are only intended for use while docking your vessel. Use of these features in other instances is at your own risk.

Visibility, lighting, and other environmental conditions may affect the performance of this feature. You must remain aware of your surroundings while docking your vessel.

⚠ CAUTION

The proximity beeper is off by default. To receive proximity alerts, you must enable and unmute the proximity beeper and ensure that the Beeper setting is turned on ([Enabling the Proximity Beeper, page 192](#)). Failure to make the proximity alert audible could lead to injury or property damage.

You can configure the Surround View Camera System to automatically detect objects within a specified range and provide both visual and audible alerts. This is only intended to assist with docking.

When the visual bumper, the distance marker, or both are set to Active, they automatically detect objects that contact the bumper or marker and those areas change color to identify the objects to alert you to a potential collision. This setting is shared with all compatible displays connected to the network.

You can also enable and configure an audible proximity beeper to sound when objects are detected in the specified range. Some proximity beeper settings are shared on the network, but not all. You may have to configure some settings on each display where you want to receive audible alerts ([Enabling the Proximity Beeper, page 192](#)).

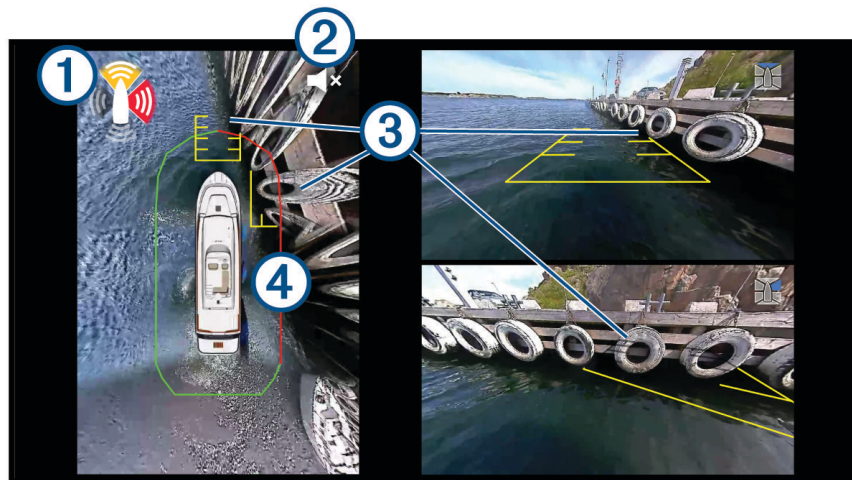

- | | |
|---|---|
| ① | Proximity beeper alert notification. Indicates the area of the boat sending the proximity alert (port, starboard, bow, and stern). The color of the shaded area indicates the estimated severity of the alert: <ul style="list-style-type: none">● Yellow: Level 1 - slow, repeated beep● Orange: Level 2 - faster, repeated beep● Red: Level 3 - continuous beep |
| ② | Proximity beeper status (Object Detection and Proximity Alert, page 191)
TIP: You can select this icon to quickly mute and unmute the proximity beeper. |
| ③ | Gray shaded lines indicated objects detected on the distance marker |
| ④ | Red lines indicate objects detected on the virtual bumper |

Enabling the Proximity Beeper

⚠ CAUTION

The proximity beeper is off by default. To receive proximity alerts, you must enable and unmute the proximity beeper and ensure that the system Beeper setting is turned on. Failure to make the proximity alert audible could lead to injury or property damage.

You can enable and configure the behavior of the proximity alert when objects are detected in the specified regions of the boat. Some settings are shared with all of the connected chartplotters on the network, others must be independently set on each chartplotter:

- The enabled and disabled regions of the vessel are shared on the network.
- The status of the beeper itself is not shared on the network. You must enable, disable, or mute the proximity beeper on each chartplotter separately.

- 1 From the surround view camera screen, select **Options > Proximity Beeper**.
- 2 Select the region or regions of the boat where you want to enable the proximity beeper.
NOTE: You must select at least one region on the boat to enable the proximity beeper.
- 3 If necessary, select **Beeper** to unmute the proximity beeper.

Proximity Beeper Mute Behavior

CAUTION

Even if the proximity beeper is enabled and unmuted, leaving the Surround View screen mutes the proximity beeper. Return to the Surround View screen to unmute it.

The proximity beeper is muted and unmuted in multiple situations:

- On a touchscreen device, touching  × mutes and unmutes the beeper.
- On a keyed device, selecting **Options > Proximity Beeper** mutes and unmutes the beeper.
- If you leave the Surround View screen, the proximity beeper is muted. Returning to the Surround View screen unmutes the beeper.
- If you turn off all alarms on the chartplotter, the proximity beeper is also turned off (*Sounds and Display Settings, page 200*).
- Because the feature is intended only for docking, when underway, the proximity beeper is muted when the vessel speed exceeds 16 kph (10 mph). When the vessel speed falls below 16 kph (10 mph), the beeper is unmuted.

LED Lighting Control

If you have installed a Garmin Spectra™ lighting controller, you can use the chartplotter to activate and change connected LED lights. You can quickly turn LED lights on and off, and you can adjust the brightness, color, and effects. You can also create groups of connected LED lights and specialized scenes to quickly toggle different lights and lighting effects.

When a compatible Fusion® stereo is connected to the same NMEA 2000® as the Garmin Spectra lighting controller and chartplotter, you can control lights from the stereo and you can configure lights so they react to music played on the stereo.

Before you can access LED lighting control on the chartplotter, you must install one or more Garmin Spectra lighting controllers and connect your LED lights. See the installation instructions provided with the Garmin Spectra lighting controller for installation details.

You can access LED lighting screen by selecting **Vessel > Lighting**.

WARNING

Setting some LED light effects or setting the LED lights to react to music may result in lights flashing at various intervals. Consult your physician if you have epilepsy or are sensitive to bright or flashing lights.

NOTICE

Before you can control any connected lights using the chartplotter or a compatible stereo, you must first initialize the lights (*Initializing Connected LED Lights*, page 194).

Using certain LED colors on your vessel, such as red and green, may violate the laws, regulations, and standards related to the use and/or operation of marine navigation lights. It is the user's responsibility to comply with any such applicable laws, regulations, and standards. Garmin® is not responsible for any fines, penalties, citations, or damages that may be incurred due to any such lack of compliance.

LED Light Controller Configuration

You can configure information about the connected Garmin Spectra™ lighting controllers and connected LED lights. You must define the type of LED lights connected before you can use them in the software on your connected chartplotter or stereo.

Initializing Connected LED Lights

Before you can interact with any connected LED lights using the chartplotter or stereo, you must first initialize the lights by providing information about the type of light source supported by the connected LEDs.

- 1 From the lighting control screen, select **Options > Installation > Lights**.

A list of all available lights is shown. Any light indicated with a yellow circle and Not Used as the Light Output must be initialized before it's available for use by the system.

- 2 Select a light from the list on the left.

- 3 Select **Light Output** and select the type of LEDs connected:

- **RGB**: The connected dimmable LEDs support a full range of colors.
- **RGBW**: The connected dimmable LEDs support a full range of colors and high quality white light.
- **CRGBW**: The connected dimmable LEDs support a full range of colors and multiple temperature white light.
- **Single Channel**: The dimmable LEDs support one dedicated color.

TIP: You can select Identify to illuminate the selected light to help identify and test the selected LED type.

- 4 Repeat this procedure for all connected lights until all of the intended LED lights are initialized.

Renaming an LED Light

You can provide a custom name to a connected LED light to make it easier to identify on the LED lighting control screen and in configuration menus.

Custom LED light names are synchronized across chartplotters and stereos connected to the same Garmin BlueNet™ network or Garmin® Marine Network. Custom LED light names are not synchronized across the NMEA 2000® network, so you should connect your devices using a Garmin BlueNet network or Garmin Marine Network connection for the best experience between devices.

- 1 From the lighting control screen, select **Options > Installation > Lights**.

A list of all available lights is shown.

- 2 Select a light you want to rename.

- 3 Select **Rename**, and enter a new name for the light.

Associating LED Lights with an Audio Zone

If a Garmin Spectra™ lighting controller is connected to the same NMEA 2000® network as a compatible Fusion® stereo, you can associate connected lights with an audio zone on the stereo. When lights are associated with an audio zone on a stereo, you can configure the lights to synchronize with the music playing on the associated audio zone.

- 1 From the lighting control screen, select **Options > Installation > Lights**.
A list of all available lights and light groups is shown.
- 2 Select a light you want to associate with an audio zone from the list on the left.
- 3 Select **Audio Zones > Select Audio Zone**.
A list of audio zones on all connected compatible Fusion stereos is shown.
- 4 Select the audio zone to which you want to associate the lights.

Renaming an LED Lighting Controller

By default, all lighting controllers connected to the same NMEA 2000® network as the chartplotter are assigned a general name. You can rename connected controllers for easier identification.

Lighting controller information, such as the history of connected controllers and custom names, is synchronized across chartplotters and stereos connected to the same Garmin BlueNet™ network or Garmin® Marine Network. This information is not synchronized across the NMEA 2000 network, so you should connect your devices using a Garmin BlueNet network or Garmin Marine Network connection for the best experience between devices.

- 1 From the lighting control screen, select **Options > Installation > Lighting Controllers**.
A list of all connected lighting controllers is shown.
- 2 Select a lighting controller.
- 3 Select **Rename**, and enter a new name for the lighting controller.

Removing an LED Lighting Controller

When you connect a lighting controller to the same NMEA 2000® network as the chartplotter, the lighting controller information is saved on the chartplotter, even if you disconnect the lighting controller. If you are completely removing a controller or replacing it with a new controller, you can remove the saved information about the old controller from the chartplotter.





Lighting controller information, such as the history of connected controllers and custom names, is synchronized across chartplotters and stereos connected to the same Garmin BlueNet™ network or Garmin® Marine Network. This information is not synchronized across the NMEA 2000 network, so you should connect your devices using a Garmin BlueNet network or Garmin Marine Network connection for the best experience between devices.

- 1 From the lighting control screen, select **Options > Installation > Lighting Controllers**.
A list of all connected lighting controllers is shown. Disconnected controllers are indicated by a black X.
- 2 Select a lighting controller you want to remove.
- 3 Select **Forget**.

LED Lighting Control Screen

You can access LED lighting screen by selecting **Vessel > Lighting**.



	Turns off all connected lights and scenes.
Scenes	Shows all created scenes.
Lights	Shows all connected LED lights and light groups.
	Creates a new scene.
①	Light, light group, or scene name and information. Select to turn a light or light group on and off. Select to start a scene.
②	Shows whether the light or light group on and off.
	Quickly adjust the brightness of the light, light group, or scene.
	Quickly edit the properties, color, and effects of a light, light group, or scene.

Turning LED Lights On and Off

- 1 From the lighting control screen, select **Options > Edit Light**.

A list of all available lights and light groups is shown.

- 2 Select a light or light group.

- 3 Select **Turn On** or **Turn Off**.

TIP: You can select the toggle switch on the light or light group directly from the lighting control screen to quickly turn lights and light groups on and off.

Adjusting LED Light Brightness

- 1 From the lighting control screen, select **Options > Edit Light**.

A list of all available lights and light groups is shown.

- 2 Select the light or light group you want to adjust.

- 3 Adjust the brightness level on the bottom of the screen for the selected light or light group.

TIP: You can select  on the light or light group directly from the lighting control screen to quickly adjust the brightness for a light or group of lights.

Changing LED Light Color

- 1 From the lighting control screen, select **Options > Edit Light**.

A list of all available lights and light groups is shown.

- 2 Select a light or light group.

- 3 Select **Color Pick > Color**.

- 4 Depending on the type of light connected, select an option:

- To change the RGB color of a connected light, select **Color**.
- To change the tone of a white light, select **White**.

A color or white light gradient window is shown, along with a set of predefined colors or white light selections.

- 5 Select a color or white tone.

TIP: You can select  on the light or light group directly from the lighting control screen to quickly adjust the color or effect for a light or group of lights.

Changing LED Light Effects

WARNING

Selecting some LED light effects may result in lights flashing at various intervals. Consult your physician if you have epilepsy or are sensitive to bright or flashing lights.

- 1 From the lighting control screen, select **Options > Edit Light**.

A list of all available lights and light groups is shown.

- 2 Select the light or light group you want to adjust.

- 3 Select **Effects > Effect**.

A list of predefined lighting effects is shown

- 4 Select an effect from the list.

The screen shows the colors and pattern included in the effect, and the affected light or light group starts using the selected effect.

- 5 If necessary, select **Effect**, and choose a different effect until the light or group of lights uses the preferred effect.

TIP: You can select  on the light or light group directly from the lighting control screen to quickly adjust the effect or color for a light or group of lights.

Setting LED Lights to React to Music

You must associate a light or light group with an audio zone on a connected compatible stereo before you can use the Audio Sync feature and have the lights react to music playing on the stereo (*Associating LED Lights with an Audio Zone*, page 195).

WARNING

Setting LED lights to react to music may result in lights flashing at various intervals. Consult your physician if you have epilepsy or are sensitive to bright or flashing lights.

- 1 From the lighting control screen, select **Options > Edit Light**.
A list of all available lights and light groups is shown.
- 2 Select the light or light group you want to adjust.
- 3 Select **Audio Sync**.
- 4 Depending on the type of light connected, select an option:
 - If you want the lights to react to quieter and louder elements of the music playing, select **Mode > Color Blend**.
 - If you want the lights to react to the bass and treble frequencies of the music playing, **Mode > Audio Spectrum**.

- 5 If necessary, select the colors associated with the quieter, louder, bass, and treble elements depending on the selected mode.

TIP: You can select  on the light or light group directly from the lighting control screen to quickly adjust the color or effect for a light or group of lights.

LED Light Scenes

A scene is a collection of LED lights that you can set to change to a defined set of colors and effects. You can create up to 20 scenes, with any number of connected lights or light groups in each scene. You can configure all of the lights in a scene to behave the same way or independently of one another.

A scene is different from a light group because you can add a light or light group to any number of scenes you create. You are not limited to how many scenes contain a connected light or light group. A light group is more restrictive and defines specific lights that you want to regularly behave the same way (*LED Light Groups*, page 198).

LED light scenes you create are synchronized across chartplotters and stereos connected to the same Garmin BlueNet™ network or Garmin® Marine Network. LED light scene information is not synchronized across the NMEA 2000® network, so you should connect your devices using a Garmin BlueNet network or Garmin Marine Network connection for the best experience between devices.

Creating a new LED Light Scene

- 1 From the lighting control screen, select **Scenes**.
- 2 Select **Options > Create New Scene**.

TIP: You can select  from the lighting control screen at any time to quickly create a new scene.

- 3 Enter a name for the scene, and select **Done**.

The new scene appears on the lighting control screen.

After creating the scene, you should edit the scene to add or remove lights and define how you want them to behave when you run the scene.

Editing an LED Light Scene

- 1 From the lighting control screen, select **Scenes**.
- 2 Select **Options > Edit Scene**.
- 3 Select the name of the scene.

TIP: You can select  on a scene directly from the lighting control screen to quickly edit the scene.

- 4 To edit the scene behavior, select one or more options:
 - To rename the scene, select **Rename**, and enter the new name.
 - If you've changed the status and behavior of lights in the scene and want to update the scene to use the present state of all lights in the scene, select **Resave Scene**.
 - To add or remove lights or light groups from the scene, select **Add/Remove Lights**, and select the lights and light groups you want to include in the scene.

Starting an LED Light Scene

Before you can start a scene, you must create at least one scene.

- 1 From the lighting control screen, select **Scenes**.

- 2 Select ► on a scene to start it.

TIP: If you want to turn off all lights in a scene, select **Options > Edit Scene**, select the name of the scene, and select Turn Off Lights.

Deleting an LED Light Scene

You can remove any LED light scenes you created. Deleting a scene does not affect any lights or light groups that were added to the scene.

- 1 From the lighting control screen, select **Scenes**.

- 2 Select **Options > Delete Scene**.

- 3 Select the name of the scene you want to delete, and select **Yes** to confirm.

LED Light Groups

A group consists of two or more connected LED lights associated with one another so they regularly behave the same way. For example, you may have LEDs on a set of speakers connected to one port on a lighting controller, and you may have LEDs on a subwoofer in the same area connected to another port on the lighting controller. By adding both of these sets of lights to a group, they will appear as one toggle on the lighting page and turn on and off together.

A group is different from a scene because a connected LED light can only belong to one group at a time. Also, a group appears on the Lights tab in the lighting page along with other connected lights.

LED light groups you create are synchronized across chartplotters and stereos connected to the same Garmin BlueNet™ network or Garmin® Marine Network. LED light-group information is not synchronized across the NMEA 2000® network, so you should connect your devices using a Garmin BlueNet network or Garmin Marine Network connection for the best experience between devices.

Creating and Adding Lights to an LED Light Group

- 1 From the lighting control screen, select **Options > Installation > Lights**.

A list of all available lights is shown.

- 2 Select a light you would like to add to a light group and select **Light Group > Select Group**.

- 3 Select **Create New Group**, and enter the name for the new group.

The new group is created, and the selected light is added to the group.

- 4 Select another light to add to the light group, and select **Light Group > Select Group**.

- 5 Select the name of the light group to add the light to the group.

- 6 Repeat until the group contains all of the lights you want to add.

Editing an LED Light Group

- 1 From the lighting control screen, select **Options > Installation > Lights**.

A list of all available lights is shown.

- 2 Select a light to add or remove from a group.

- 3 Select **Light Group**, and select an option:

- To add the light to a group, select **Select Group**.
- To move the light to a different group, select **Change Group**, and select a different group or create a new group.
- To remove the light from a group, select **Remove From Group**.

- 4 Repeat for any additional lights until they are grouped as preferred.

Renaming an LED Light Group

LED light group information is synchronized across chartplotters and stereos connected to the same Garmin BlueNet™ network or Garmin® Marine Network.

- 1 From the lighting control screen, select **Options > Installation > Lights**.
A list of all available lights is shown.
- 2 Select a light in the group you want to rename.
- 3 Select **Light Group > Rename**, and enter a new name for the group.

Device Configuration

System Settings

Select  > **System**.

Sounds and Display: Adjusts the display settings and the audio settings (if available).

Satellite Positioning: Provides information about the GPS satellites and settings.

System Information: Provides information about the devices on the network and the software version.

Station Information: Adjusts the setup of the station.

Auto Power Up: Controls which devices turn on automatically when power is applied.

Auto Power Off: Automatically turns off the system after it has been asleep for the selected length of time.

Simulator: Turns the simulator on or off and allows you to set the time, date, speed, and simulated location.

Sounds and Display Settings

Select  > **System** > **Sounds and Display**.

Beeper: Turns on and off the tone that sounds for alarms and selections.

Audio Setup: Sets up the audio output.

Backlight: Sets the backlight brightness. You can select the Auto option to adjust the backlight brightness automatically based on the ambient light.

Backlight Sync: Synchronizes the backlight brightness of other chartplotters in the station.

Color Mode: Sets the device to display day or night colors. You can select the Auto option to allow the device to set day or night colors automatically based on the time of day.

Startup Image: Sets the image that appears when you turn on the device.

Startup Layout: Sets the layout that appears when you turn on the device.

Screen Lock: Sets the anti-theft feature that requires a security PIN (Personal Identification Number) to prevent unauthorized use of the device ([Enabling Screen Lock, page 23](#)).

Audio Settings

You can adjust audible alarms, alerts, and warnings that are sounded over connected audio devices. You can connect an audio device using the NMEA® 0183 Audio Cable accessory. Models that support HDMI® audio out can sound audio alarms through a device connected using HDMI.

Select  > **System** > **Sounds and Display** > **Audio Setup**.

Audio Output: Turns on the audio output for audio alerts. This turns on the audio output through HDMI for models that support HDMI audio out.

Audio Alerts: Sets which system alarms and alerts are played over the compatible audio output. An alarm indicates a situation could be hazardous to passengers and requires immediate action. A warning indicates the situation could be hazardous to equipment on the vessel or the vessel itself and requires action very soon. All other messages and information are classified as alerts.

Audio Alert Language: Sets the spoken language for alerts.

Audio Alert Device: Sets the device to control when alerts are played.

Audio Alert Source: Switches the audio device to the selected source when an alert is played.

Alert Volume: Controls the volume of the alerts.

Satellite Positioning (GPS) Settings

These settings may change depending on the selected GPS source. Not all options are available on all models.

Select  > **System** > **Satellite Positioning**.

Source: Allows you to select the preferred source for GPS data.

Speed Filter: Averages the speed of your vessel over a short period of time for smoother speed values.

WAAS/EGNOS: Turns on or off WAAS data (in North America) or EGNOS data (in Europe), which can provide more-accurate GPS position information. When using WAAS or EGNOS data, the device may take longer to acquire satellites.

Positioning Mode > GPS Only: The GPS source uses only GPS satellites for position data.

Positioning Mode > GPS and GLONASS: The GPS source uses both GPS satellites and GLONASS (Russia satellite system) for position data. When the system is used in situations with poor sky visibility, GLONASS data can be used in combination with GPS to provide more accurate position information.

Positioning Mode > Multi-Constellation: The GPS source uses GPS data from all available satellite constellations for position data.

Positioning Mode > Multi-Constellation and Multi-Frequency: The GPS source uses GPS data from all available satellite constellations as well as both L1 and L5 frequencies for position data.

Station Settings

Select  > **System** > **Station Information**.

Change Station: Sets the entire station to a new set of defaults based on the location of this station. You can also select to use this display as a stand-alone, individual display, instead of grouping it with other displays to make a station.

Input Device Pairing: Allows you to pair a GRID™ remote input device or other compatible input device with this station.

Display Order: Sets the order of the displays, which is important when using a GRID remote input device.

Autopilot Enabled: Allows you to control the autopilot from this device.

Reset Layouts: Resets the layouts in this station to the factory default settings.

Reset Station Settings: Resets all station settings to on all connected devices in the station to the factory default settings, and requires initial station setup.

Viewing System Software Information

You can view the software version, the basemap version, all supplemental map information (if applicable), the software version for an optional Garmin® radar (if applicable), and the unit ID number. You may need this information to update the system software or to purchase additional map data information.

Select  > **System** > **System Information** > **Software Information**.

Viewing the Event Log

The event log shows a list of system events.

- 1 Select  > **System** > **System Information** > **Event Log**.
- 2 If necessary, select an event in the list, and select **Review** to view more information about the event.

Sorting and Filtering Events

- 1 From the **Event Log**, select **Sort By**.
- 2 Select an option to sort or filter the event log.

Saving Events to a Memory Card

- 1 Insert a memory card into the card slot.
- 2 From the **Event Log**, select **Save to Card**.

Clearing All of the Events From the Event Log

From the **Event Log**, select **Clear Event Log**.

Viewing E-label Regulatory and Compliance Information

The label for this device is provided electronically. The e-label may provide regulatory information, such as identification numbers provided by the FCC or regional compliance markings, as well as applicable product and licensing information. Not available on all models.

- 1 Select .
- 2 Select **System**.
- 3 Select **Regulatory Information**.

Preferences Settings

Select  > **Preferences**.

Units: Sets units of measure.

Language: Sets the on-screen text language.

Navigation: Sets navigation preferences.

Filters: Smooths out the values shown in the data fields, which can decrease the noise or show longer term trends. Increasing the filter setting increases the smoothing and decreasing it reduces the smoothing. A filter setting of 0 will disable the filter and the value shown will be the raw value from the source. You can also synchronize these settings across all devices that enable the Sync Filters setting.

Keyboard Layout: Arranges the keys on the on-screen keyboard.

Screenshot Capture: Allows the device to save images of the screen.

Menu Bar Display: Shows or automatically hides the menu bar when it is not needed.

Units Settings

Select  > **Preferences** > **Units**.

System Units: Sets the unit format for the device. For example, **Custom** > **Depth** > **Fathoms** sets the unit format for depth to Fathoms.

Variance: Sets the magnetic declination, the angle between magnetic north and true north, for your present location.

North Reference: Sets the direction references used in calculating heading information. True sets geographic north as the north reference. Grid sets grid north as the north reference (000°). Magnetic sets the magnetic north as the north reference.

Position Format: Sets the position format in which a given location reading appears. Do not change this setting unless you are using a map or chart that specifies a different position format.

Map Datum: Sets the coordinate system on which the map is structured. Do not change this setting unless you are using a map or chart that specifies a different map datum.

Time: Sets the time format, time zone, and daylight saving time.

Navigation Settings

NOTE: Some settings and options require additional charts or hardware.

Select  > **Preferences** > **Navigation**.

Route Labels: Sets the type of labels shown with route turns on the map.

Turn Transition: Adjusts how the chartplotter transitions to the next turn or leg or the route. You can set the transition to be based on time or distance before the turn. You can increase the time or distance value to help improve the accuracy of the autopilot when navigating a route or an Auto Guidance line with many frequent turns or at higher speeds. For straighter routes or slower speeds, lowering this value can improve autopilot accuracy.

Speed Sources: Sets the source for the speed readings.

Auto Guidance: Sets the measurements for the Preferred Depth, Vertical Clearance, and Shoreline Distance, when you are using some premium maps.

Route Start: Selects a starting point for route navigation.

Auto Guidance Path Configurations

CAUTION

The Preferred Depth and Vertical Clearance settings influence how the chartplotter calculates an Auto Guidance path. If a section of an Auto Guidance path is shallower than the Preferred Depth or lower than the Vertical Clearance settings, the section of the Auto Guidance path appears as a solid orange line or a red striped line in Garmin Navionics+™ and Garmin Navionics Vision+™ charts and appears as a magenta and gray striped line in previous versions. When your boat enters one of those areas, a warning message appears ([Route Color Coding, page 57](#)).

NOTE: Auto Guidance is available with premium charts, in some areas.

Not all settings apply to all maps.

You can set the parameters the chartplotter uses when calculating an Auto Guidance path.

Select  > **Preferences** > **Navigation** > **Auto Guidance**.

Preferred Depth: Sets the minimum water depth, based on chart depth data, that your boat can safely travel over.



NOTE: The minimum water depth for the premium charts (made before 2016) is 3 feet. If you enter a value of less than 3 feet, the charts only use depths of 3 feet for Auto Guidance path calculations.



Vertical Clearance: Sets the minimum height of a bridge or obstacle, based on chart data, that your boat can safely travel under.

Shoreline Distance: Sets how close to the shore you want the Auto Guidance path to be placed. The path may move if you change this setting while navigating. The available values for this setting are relative, not absolute. To ensure that path is placed the appropriate distance from shore, you can assess the placement of the path using one or more familiar destinations that require navigation through a narrow waterway ([Adjusting the Distance from Shore, page 63](#)).

Adjusting the Distance from Shore

The Shoreline Distance setting indicates how close to the shore you want the Auto Guidance line to be placed. The Auto Guidance line may move if you change this setting while navigating. The available values for the Shoreline Distance setting are relative, not absolute. To ensure the Auto Guidance line is placed the appropriate distance from shore, you can assess the placement of the Auto Guidance line using one or more familiar destinations that require navigation through a narrow waterway.

- 1 Dock your vessel or drop the anchor.
- 2 Select  > **Preferences** > **Navigation** > **Auto Guidance** > **Shoreline Distance** > **Normal**.
- 3 Select a destination that you have navigated to previously.
- 4 Select **Navigate To** > **Auto Guidance**.
- 5 Review the placement of the **Auto Guidance** line, and determine whether the line safely avoids known obstacles and the turns enable efficient travel.
- 6 Select an option:
 - If the placement of the line is satisfactory, select **Options** > **Navigation Options** > **Stop Navigation**, and proceed to step 10.
 - If the line is too close to known obstacles, select  > **Preferences** > **Navigation** > **Auto Guidance** > **Shoreline Distance** > **Far**.
 - If the turns in the line are too wide, select  > **Preferences** > **Navigation** > **Auto Guidance** > **Shoreline Distance** > **Near**.
- 7 If you selected **Near** or **Far** in step 6, review the placement of the **Auto Guidance** line, and determine whether the line safely avoids known obstacles and the turns enable efficient travel.

Auto Guidance maintains a wide clearance from obstacles in open water, even if you set the Shoreline Distance setting to Near or Nearest. As a result, the chartplotter may not reposition the Auto Guidance line, unless the destination selected requires navigation through a narrow waterway.
- 8 Select an option:
 - If the placement of the line is satisfactory, select **Options** > **Navigation Options** > **Stop Navigation**, and proceed to step 10.
 - If the line is too close to known obstacles, select  > **Preferences** > **Navigation** > **Auto Guidance** > **Shoreline Distance** > **Farthest**.
 - If the turns in the line are too wide, select  > **Preferences** > **Navigation** > **Auto Guidance** > **Shoreline Distance** > **Nearest**.
- 9 If you selected **Nearest** or **Farthest** in step 8, review the placement of the **Auto Guidance** line, and determine whether the line safely avoids known obstacles and the turns enable efficient travel.

The Auto Guidance path maintains a wide clearance from obstacles in open water, even if you set the Shoreline Distance setting to Near or Nearest. As a result, the chartplotter may not reposition the Auto Guidance line, unless the destination selected requires navigation through a narrow waterway.
- 10 Repeat steps 3 through 9 at least once more, using a different destination each time, until you are familiar with the functionality of the **Shoreline Distance** setting.

Communications Settings

Viewing Connected Devices

You can view lists of the connected devices on the vessel including which chartplotter a device is connected to or paired with.

- 1 Select  > **Communications**.
- 2 Select a network.
- 3 Select **Device List**.

A list of network devices appears. If a device is connected to or paired with a specific chartplotter, the name of the chartplotter is shown along with the device name.

NOTE: Some devices included in the NMEA 2000® device list may be connected to a chartplotter at another station on the vessel. You can select **Related To:** to see more information about which chartplotter the device is connected to.

NMEA® 0183 Settings

Select  > **Communications** > **NMEA 0183 Setup**.

Port Types: See [Setting the Communication Format for Each NMEA® 0183 Port, page 204](#).

Output Sentences: See *Configuring NMEA® 0183 Output Sentences*, page 204.

Position Precision: Adjusts the number of digits to the right of the decimal point for transmission of NMEA output.

XTE Precision: Adjusts the number of digits to the right of the decimal point for NMEA crosstalk error output.

Waypoint IDs: Sets the device to transmit waypoint names or numbers using NMEA 0183 while navigating. Using numbers may resolve compatibility issues with older NMEA 0183 autopilots.

Restore Defaults: Restores the NMEA 0183 settings to the original factory default values.

Diagnostics: Displays NMEA 0183 diagnostic information.

Configuring NMEA® 0183 Output Sentences

You can enable and disable NMEA 0183 output sentences.

- 1 Select  > **Communications** > **NMEA 0183 Setup** > **Output Sentences**.
- 2 Select an option.
- 3 Select one or more NMEA 0183 output sentences, and select **Back**.
- 4 Repeat steps 2 and 3 to enable or disable additional output sentences.

Setting the Communication Format for Each NMEA® 0183 Port

You can configure the communication format for each internal NMEA 0183 port when connecting your chartplotter to external NMEA 0183 devices, a computer, or other Garmin® devices.

- 1 Select  > **Communications** > **NMEA 0183 Setup** > **Port Types**.
- 2 Select an input or output port.
- 3 Select a format:
 - To support the input or output of standard NMEA 0183 data, DSC, and sonar NMEA input support for the DPT, MTW, and VHW sentences, select **NMEA Std.**
 - To support the input or output of standard NMEA 0183 data for most AIS receivers, select **NMEA High Speed**.
 - To support the input or output of Garmin proprietary data for interfacing with Garmin software, select **Garmin**.
- 4 Repeat steps 2 and 3 to configure additional input or output ports.

NMEA 2000® Settings

Select  > **Communications** > **NMEA 2000 Setup**.

Device List: Displays the devices connected to the network and allows you to set options for some transducers connected using the NMEA 2000 network.

Label Devices: Changes the labels for available connected devices.

Naming Devices and Sensors on the Network

You can name devices and sensors connected to the Garmin® Marine Network and the NMEA 2000® network.

- 1 Select  > **Communications**.
- 2 Select **Marine Network** or **NMEA 2000 Setup** > **Device List**.
- 3 Select a device from the list on the left.
- 4 Select **Change Name**.
- 5 Enter the name, and select **Done**.

The Garmin BlueNet™ Network and the Legacy Garmin® Marine Network

The Garmin BlueNet network allows you to share data from Garmin peripheral devices with chartplotters quickly and easily. You can connect compatible devices using Garmin BlueNet technology to receive data from and share data with other connected devices and chartplotters.

There are two types of network technology used by Garmin marine devices. The legacy Garmin Marine Network technology has larger connectors and has been in use for many years. The newer Garmin BlueNet network technology has smaller connectors and is capable of higher speeds than the previous network technology. You can connect Garmin Marine Network devices to Garmin BlueNet devices to share data with one another when the network is structured properly. For more information, see garmin.com/manuals/bluenet.

You can view all of the devices connected to the Garmin BlueNet network and add or change a custom name for each device.

Select  > **Communications** > **BlueNet™ Network** or **Marine Network**.

Setting Alarms

⚠ CAUTION

The Beeper setting must be turned on to make alarms audible (*Sounds and Display Settings, page 200*). Failure to set audible alarms could lead to injury or property damage.

Navigation Alarms

Select  > **Alarms** > **Navigation**.

Arrival: Sets an alarm to sound when you are within a specified distance or time from a turn or a destination.

Anchor Drag: Sets an alarm to sound when you exceed a specified drift distance while anchored.

⚠ WARNING

The anchor drag alarm is a tool for situational awareness only and may not prevent groundings or collisions in all circumstances. You are responsible for the safe and prudent operation of your vessel, for remaining aware of your surroundings, and for using safe judgment on the water at all times.

Off Course: Sets an alarm to sound when you are off course by a specified distance.

Boundary Alarms: Disables and enables all boundary alarms.

Setting the Anchor Drag Alarm

You can set an alarm to sound if you have moved outside an allowable radius you set when configuring the alarm.

⚠ WARNING

The anchor drag alarm is a tool for situational awareness only, and may not prevent grounding or collisions in all circumstances. You are responsible for the safe and prudent operation of your vessel, for remaining aware of your surroundings, and for using safe judgement on the water at all times. Failure to heed this warning could result in property damage, serious personal injury, or death.

⚠ CAUTION

The Beeper setting must be turned on to make alarms audible (*Sounds and Display Settings, page 200*). Failure to set audible alarms could lead to injury or property damage.

- 1 Select  > **Alarms** > **Navigation** > **Anchor Drag**.
- 2 Select **Alarm** to turn on the alarm.
- 3 Select **Set Radius**, and select a distance on the chart.
- 4 Select **Back**.

System Alarms

Select  > **Alarms** > **System**.

Sets an alarm clock.

Unit Voltage: Sets an alarm to sound when the battery reaches a specified low voltage.

GPS Accuracy: Sets an alarm to sound when the GPS location accuracy falls outside the user-defined value.

Sonar Alarms

⚠ WARNING

The sonar alarms feature is a tool for situational awareness only and may not prevent grounding in all circumstances. It is your obligation to ensure safe operation of the vessel.

⚠ CAUTION

The Beeper setting must be turned on to make alarms audible (*Sounds and Display Settings, page 200*). Failure to set audible alarms could lead to injury or property damage.

NOTE: Not all options are available on all transducers.

From an applicable sonar view, select **Options** > **Sonar Setup** > **Alarms**.

You can also open the sonar alarms by selecting  > **Alarms** > **Sonar**.

Shallow Water: Sets an alarm to sound when the depth is less than the specified value.



Deep Water: Sets an alarm to sound when the depth is greater than the specified value.

FrontVü Alarm: Sets an alarm to sound when the depth in front of the vessel is less than the specified value, which can help you avoid running aground ([Setting the Garmin FrontVü™ Depth Alarm, page 97](#)). This alarm is available only with Panoptix™ Garmin FrontVü™ transducers.

Water Temp.: Sets an alarm to sound when the transducer reports a temperature that is 2°F (1.1°C) above or below the specified temperature.

Contour: Sets an alarm to sound when the transducer reports a water depth below a specified shallow limit or above a specified deep limit. This helps by calling attention when encountering a steep drop-off or a sudden shallow area.

Fish: Sets an alarm to sound when the device detects a suspended target.

-  sets the alarm to sound when fish of all sizes are detected.
-  sets the alarm to sound only when medium or large fish are detected.
-  sets the alarm to sound only when large fish are detected.

Setting Weather Alarms

Before you can set weather alarms, you must have a compatible chartplotter connected to a weather device, such as a GXM™ device, and have a valid weather subscription.

- 1 Select  > **Alarms > Weather**.
- 2 Turn on alarms for specific weather events.

Setting the Fuel Alarm

CAUTION

The Beeper setting must be turned on to make alarms audible ([Sounds and Display Settings, page 200](#)). Failure to set audible alarms could lead to injury or property damage.

Before you can set a fuel level alarm, you must connect a compatible fuel flow sensor to the chartplotter.

You can set an alarm to sound when the total amount of remaining onboard fuel reaches the level you specify.

- 1 Select  > **Alarms > Fuel > Total Fuel Onboard > On**.
- 2 Enter the remaining amount of fuel that triggers the alarm, and select **Done**.

My Vessel Settings

NOTE: Some settings and options require additional charts or hardware.

Select  > **My Vessel**.

Transducers: Shows all transducers on the network, allows you to change transducers, and allows you to view diagnostic information ([Selecting the Transducer Type, page 88](#)).

Depth and Anchoring: Allows you to enter information about the keel ([Setting the Keel Offset, page 73](#)) and the anchor.

The Anchor Height value is the height of the anchor above the waterline. The Anchor Scope value is the ratio of the length of anchor rode in use to the vertical distance from the bow of the vessel to the bottom of the water. These anchor settings are used to calculate the Target Anchor Rode date field.

Temp. Offset: Allows you to set an offset value to compensate for the water temperature reading from a connected water-temperature sensor or a temperature-capable transducer ([Setting the Water Temperature Offset, page 207](#)).

Calibrate Water Speed: Calibrates the speed-sensing transducer or sensor ([Calibrating a Water-Speed Device, page 208](#)).

Fuel: Sets the combined fuel capacity and fuel remaining in the fuel tanks on your vessel ([Fuel Settings, page 208](#)).

Vessel Type: Enables some chartplotter features based on the boat type.

Switching: Sets the digital switching circuits, such as SeaStar® and CZone™ devices.

Polar Table: Enables polar table data, when the vessel type is not a powerboat.

System Profiles: Allows you to save your system profile to a memory card and import system profile settings from a memory card. This can be helpful for charter or fleet vessels, and for sharing your setup information with a friend.

Hull ID Number: Allows you to enter the Hull Identification Number (HIN). The HIN might be permanently affixed to the upper starboard side of the transom or outboard side.

Optimus Steering: Allows you to adjust the Optimus® steering parameters.

Setting the Keel Offset

You can enter a keel offset to compensate the water depth reading for the transducer installation location. This allows you to view the depth of the water below the keel or the true depth of the water, depending on your needs.

If you want to know the water depth below the keel or the lowest point of your boat and the transducer is installed at the water line or anywhere above the end of the keel, measure the distance from the transducer location to the keel of the boat.

If you want to know the true water depth and the transducer is installed below the water line, measure the distance from the bottom of the transducer up to the water line.

NOTE: This option is only available when you have valid depth data.

1 Measure the distance:

- If the transducer is installed at the water line ① or anywhere above the end of the keel, measure the distance from the transducer location to the keel of the boat. Enter this value as a positive number.
- If the transducer is installed at the bottom of the keel ② and you want to know the true depth of the water, measure the distance from the transducer to the water line. Enter this value in as a negative number.

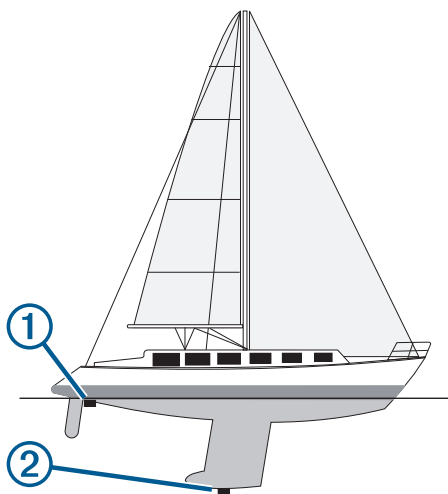

2 Complete an action:

- If the transducer is connected to the chartplotter or a sonar module, select **⚙️ > My Vessel > Depth and Anchoring > Keel Offset**.
- If the transducer is connected to the NMEA 2000® network, select **⚙️ > Communications > NMEA 2000 Setup > Device List**, select the transducer, and select **Review > Keel Offset**.

3 Select **+** if the transducer is installed at the water line, or select **-** if the transducer is installed at the bottom of the keel.

4 Enter the distance measured in step 1.

Setting the Water Temperature Offset

The temperature offset compensates for the temperature reading from a temperature sensor or temperature-capable transducer.

- 1 Measure the water temperature using the temperature sensor or temperature-capable transducer that is connected to the network.
- 2 Measure the water temperature using a different temperature sensor or a thermometer that is known to be accurate.
- 3 Subtract the water temperature measured in step 1 from the water temperature measured in step 2. This value is the temperature offset. Enter this value in step 5 as a positive number if the sensor measures the water temperature as being colder than it actually is. Enter this value in step 5 as a negative number if the sensor measures the water temperature as being warmer than it actually is.
- 4 Complete an action:
 - If the sensor or transducer is connected to the chartplotter or a sonar module, select **⚙️ > My Vessel > Temp. Offset**.

- If the sensor or transducer is connected to the NMEA 2000® network, select  > **Communications** > **NMEA 2000 Setup** > **Device List**, select the transducer, and select **Review** > **Temp. Offset**.

5 Enter the temperature offset value calculated in step 3.

Fuel Settings

Select  > **My Vessel** > **Fuel**.

Fuel Remaining: Allows you to use fuel flow sensors or fuel tank level sensors to monitor the fuel remaining on the vessel. The Fuel Flow option uses fuel flow sensors. The Fuel Tank option uses fuel tank level sensors.

Fuel Tank Capacity: Allows you to enter the fuel capacity of each fuel tank onboard. This setting is available when the Fuel Remaining setting is set to the Fuel Tank option. The chartplotter uses information from the tank level sensors, so you do not need to do manually enter fuel information after you fill up the tanks.

Fuel Capacity: Allows you to enter the total fuel capacity of all fuel tanks onboard. This setting is available when the Fuel Remaining setting is set to the Fuel Flow option. After you fill up your tanks with fuel, you must enter fuel information manually using one of the options below.

- If you have filled up all the fuel tanks on the vessel, select Fill Up All Tanks. The fuel level is set to maximum capacity.
- If you have added less than a full tank of fuel, select Add Fuel to Boat, and enter the amount added.
- To specify the total fuel in the vessel tanks, select Set Total Fuel Onboard, and enter the total amount of fuel in the tanks.

Fuel Economy: Determines how the fuel economy data is shown in data fields and other locations in the chartplotter.



- To show fuel economy data as it is received directly from the engine, select Instant. Not all engines support this feature.
- To allow the chartplotter to calculate the fuel economy data based on fuel-rate measurements, select Internal.
- To allow the chartplotter to either use data received from the engine or to calculate the data if it is not received by the engine, select Auto. This is the default setting.

NOTE: Garmin® is not responsible for the accuracy of fuel economy data provided by an engine.

Calibrating a Water-Speed Device

If you have a speed sensor or a speed-sensing transducer connected, you can calibrate that speed-sensing device to improve the accuracy of water-speed data displayed by the chartplotter.

1 Complete an action:

- If the sensor or transducer is connected to the chartplotter or a sonar module, select  > **My Vessel** > **Calibrate Water Speed**.
- If the sensor or transducer is connected to the NMEA 2000® network, select  > **Communications** > **NMEA 2000 Setup** > **Device List**, select the transducer, and select **Review** > **Calibrate Water Speed**.

2 Follow the on-screen instructions.

If the boat is not moving fast enough or the speed sensor is not registering a speed, a message appears.

3 Select **OK**, and safely increase the boat speed.

4 If the message appears again, stop the boat, and ensure the speed-sensor wheel is not stuck.

5 If the wheel turns freely, check the cable connections.

6 If you continue to get the message, contact Garmin® product support.

Other Vessels Settings

CAUTION

The Beeper setting must be turned on to make alarms audible (*Sounds and Display Settings, page 200*). Failure to set audible alarms could lead to injury or property damage.

When your compatible chartplotter is connected to an AIS device or VHF radio, you can set up how other vessels are displayed on the chartplotter.

Select  > **Other Vessels**.

AIS: Enables and disables AIS signal reception.

DSC: Enables and disables digital selective calling (DSC).

Collision Alarm: Sets the collision alarm (*Setting the Safe-Zone Collision Alarm, page 47*).

AIS-EPIRB Test: Enables test signals from Emergency Position Indicating Radio Beacons (EPIRB).

AIS-MOB Test: Enables test signals from man overboard (MOB) devices.

AIS-SART Test: Enables test transmissions from Search and Rescue Transponders (SART).

Settings that are Synced on the Garmin® Marine Network

Garmin ECHOMAP™ and GPSMAP® chartplotters sync certain settings when connected to the Garmin Marine Network.

The following settings are synced, if applicable, to the device.

Alarm Settings (also syncs alarm acknowledgment):

- Arrival
- Anchor Drag
- Off Course
- GPS Accuracy
- Shallow Water
- Deep Water (Not available in the GPSMAP 8400/8600 series)
- Water Temp.
- Contour (Not available in echoMAP 70s and GPSMAP 507/701 series)
- Fish
- Collision Alarm

General Settings:

- Auto Guidance Preferred Depth
- Auto Guidance Vertical Clearance
- Beeper
- Color Mode
- Keyboard Layout
- Language
- Map Datum
- Heading
- Position Format
- System Units
- Calibrate Water Speed
- Radar Antenna Size

Chart Settings:

- Chart Borders
- Hazard Colors
- Heading Line
- Land POIs
- Light Sectors
- Navaid Size
- Navaid Type
- Photo Points
- Preferred Depth
- Shallow Shading
- Service Points
- Vessel Icon (Cannot be synced between all models)

Restoring the Original Chartplotter Factory Settings

NOTE: This affects all devices on the network.

1 Select  > **System** > **System Information** > **Reset**.

2 Select an option:

- To reset the device settings to the factory default values, select **Reset Default Settings**. This restores the default configuration settings, but does not remove saved user data, maps, or software updates.
- To reset all settings in all devices in the station to the factory default values, select **Reset Station Settings**. This restores the default configuration settings, but does not remove saved user data, maps, or software updates

- To clear saved data, such as waypoints and routes, select **Delete User Data**. This does not affect maps or software updates.
- To clear saved data and reset device settings to the factory default values, disconnect the chartplotter from the Garmin® Marine Network, and select **Delete Data and Reset Settings**. This does not affect maps or software updates.

Sharing and Managing User Data

WARNING

This feature allows you to import data from other devices that may have been generated by third parties. Garmin® makes no representations about the accuracy, completeness, or timeliness of data that is generated by third parties. Any reliance on or use of such data is at your own risk.

You can share user data between compatible devices. User data includes waypoints, saved tracks, routes, and boundaries.

- User data is shared with other devices connected to the Garmin BlueNet™ network or Garmin Marine Network.
- You can share and manage user data between different devices using a memory card. The memory card you use must be formatted to a file type supported by all devices that you want to share user data. For example, if you have one device that supports only FAT32 format cards and another device that supports exFat format cards, you should use a card formatted to FAT32 so that it can be read by both devices ([Memory Cards](#), page 18).

Selecting a File Type for Third-Party Waypoints and Routes

You can import and export waypoints and routes from third-party devices.

- 1 Insert a memory card into the card slot.
- 2 Select **Where To > Manage User Data > Data Transfer > File Type**.
- 3 Select **GPX**.

To transfer data with Garmin® devices again, select the ADM file type.

Copying User Data from a Memory Card

You can transfer user data from a memory card to transfer from other devices. User data includes waypoints, routes, Auto Guidance paths, tracks, and boundaries.

NOTE: Only boundary files with an .adm extension are supported.

- 1 Insert a memory card into a card slot.
- 2 Select **Where To > Manage User Data > Data Transfer**.
- 3 If necessary, select the memory card to copy data to.
- 4 Select an option:
 - To transfer data from the memory card to the chartplotter and combine it with existing user data, select **Merge from Card**.
 - To transfer data from the memory card to the chartplotter and overwrite existing user data, select **Replace from Card**.
- 5 Select the file name.

Copying All User Data to a Memory Card

You can save all of the user data on the device to a memory card to transfer to other devices. User data includes waypoints, routes, Auto Guidance paths, tracks, and boundaries.

- 1 Insert a memory card into the card slot.
- 2 Select **Where To > Manage User Data > Data Transfer > Save All to Card**.
- 3 If necessary, select the memory card to copy the data to.
- 4 Select an option:
 - To create a new file, select **Add New File**, and enter a name.
 - To add the information to an existing file, select the file from the list, and select **Save to Card**.

Copying User Data from a Specified Area to a Memory Card

You can save user data from a specified area to a memory card to transfer to other devices. User data includes waypoints, routes, Auto Guidance paths, tracks, and boundaries.

- 1 Insert a memory card into the card slot.
- 2 Select **Where To > Manage User Data > Data Transfer > Save Area to Card**.
- 3 Select an option:
 - If you previously defined an area boundary containing user data you want to transfer, select the name of the area and select **Select Area**.

- If you want to define a new area containing user data to transfer, select **New Area**, and follow the on-screen instructions to define the area.
- 4 Select **Save Area to Card**.
 - 5 If necessary, select the memory card to copy the data to.
 - 6 Select an option:
 - To create a new file, select **Add New File**, and enter a name.
 - To add the information to an existing file, select the file from the list, and select **Save to Card**.

Updating Built-In Maps with a Memory Card and Garmin Express™

You can update the built-in maps using the Garmin Express computer application and a memory card.

- 1 Insert a memory card into the computer's card slot (*Memory Cards, page 18*).
- 2 Open the Garmin Express application.
If you do not have the Garmin Express application installed on your computer, you can download it from garmin.com/express.
- 3 If necessary, register your device (*Registering Your Device Using the Garmin Express™ App, page 214*).
- 4 Click **Vessel > View Details**.
- 5 Click **Download** next to the map to update.
- 6 Follow the on-screen instructions to complete the download.
- 7 Wait while the update downloads.
The update may take an extended period of time.
- 8 After the download is complete, eject the card from the computer.
- 9 Insert the memory card into the card slot (*Memory Cards, page 18*).
- 10 On the chartplotter, select **⚙ > System > System Information > Update Built-In Map**.
The updated chart appears on your chartplotter.

Backing Up Data to a Computer

- 1 Insert a memory card into the card slot.
- 2 Select **Where To > Manage User Data > Data Transfer > Save to Card**.
- 3 Select a file name from the list, or select **Add New File**.
- 4 Select **Save to Card**.
- 5 Remove the memory card, and insert it into a card reader attached to a computer.
- 6 Open the Garmin\UserData folder on the memory card.
- 7 Copy the backup file on the card and paste it to any location on the computer.

Restoring Backup Data to a Chartplotter

- 1 Insert a memory card into a card reader that is attached to the computer.
- 2 Copy a backup file from the computer to the memory card, into a folder named Garmin\UserData.
- 3 Insert a memory card into the card slot.
- 4 Select **Where To > Manage User Data > Data Transfer > Replace from Card**.

Saving System Information to a Memory Card

You can save system information to a memory card as a troubleshooting tool. A product support representative may ask you to use this information to retrieve data about the network.

- 1 Insert a memory card into the card slot.
- 2 Select **⚙ > System > System Information > Garmin Devices > Save to Card**.
- 3 If necessary, select the memory card to save system information to.
- 4 Remove the memory card.

Appendix

Device Care

NOTICE

Do not use a sharp object to clean the device.

Avoid chemical cleaners, solvents, and insect repellents that can damage plastic components and finishes.

Thoroughly rinse the device with fresh water after exposure to chlorine, salt water, sunscreen, cosmetics, alcohol, or other harsh chemicals. Prolonged exposure to these substances can damage the case.

Never use a hard or sharp object to operate the touchscreen, or damage may result.

Cleaning the Screen

NOTICE

Cleaners containing ammonia will harm the anti-reflective coating.

The device is coated with a special anti-reflective coating which is very sensitive to waxes and abrasive cleaners.

- 1 Apply an eyeglass lens cleaner specified as safe for anti-reflective coatings to the cloth.
- 2 Gently wipe the screen with a soft, clean, lint-free cloth.

ActiveCaptain® and Garmin Express™

The ActiveCaptain and Garmin Express apps help you manage your Garmin® chartplotter and other devices.

ActiveCaptain: The ActiveCaptain mobile app provides an easy-to-use connection between your compatible mobile device and your compatible Garmin chartplotter, charts, and the Garmin Quickdraw™ Contours Community (*ActiveCaptain® App, page 33*). The app allows you to monitor and track your boat with the OnDeck™ system. The app provides unlimited access to your cartography and a quick, mobile way to download new charts using the OneChart™ feature, provides a link to receive notifications on your chartplotter, and provides access to the ActiveCaptain Community for feedback on marinas and other boating points of interest. You can also use the app to plan your trip and sync user data. The app checks your devices for available updates, and notifies you when an update is available. You can even control the chartplotter using the Garmin Helm™ feature.

Garmin Express: The Garmin Express desktop app allows you to use your computer and a memory card to download and update Garmin chartplotter software and charts (*Garmin Express™ App, page 213*). You should use the Garmin Express app for faster data transfer of larger downloads and updates, and to avoid possible data charges with some mobile devices.

Function	ActiveCaptain mobile app	Garmin Express desktop app
Register your new Garmin Marine device	Yes	Yes
Update your Garmin chartplotter software	Yes	Yes
Update your Garmin charts	Yes	Yes
Download new Garmin charts	Yes	Yes
Access the Garmin Quickdraw Contours Community to download and share contours with other users	Yes	No
Monitor and track your boat with the OnDeck system	Yes	No
Sync a mobile device with your Garmin chartplotter	Yes	No
Access the ActiveCaptain Community for feedback on marinas and boating points of interest	Yes	No
Receive smart notification on the chartplotter	Yes	No
Control the chartplotter with Garmin Helm	Yes	No

Garmin Express™ App

The Garmin Express desktop app allows you to use your computer and a memory card to download and update Garmin® device software and charts and register your devices. We recommend it for larger downloads and updates for faster data transfer and to avoid possible data charges with some mobile devices.

Installing the Garmin Express™ App on a Computer

You can install the Garmin Express app on a Windows® or Mac® computer.

- 1 Go to garmin.com/express.
- 2 Select **Download for Windows** or **Download for Mac**.
- 3 Follow the on-screen instructions.

Registering Your Device Using the Garmin Express™ App

NOTE: You should use the ActiveCaptain® app and a mobile device to register the device (*Getting Started with the ActiveCaptain® App, page 33*).

Help us better support you by completing our online registration today. Keep the original sales receipt, or a photocopy, in a safe place.

- 1 Install the Garmin Express app on your computer (*Installing the Garmin Express™ App on a Computer, page 214*).
- 2 Insert a memory card into the chartplotter card slot (*Memory Cards, page 18*).
- 3 Wait a few moments.
The chartplotter opens the card management page and creates a file named GarminDevice.xml in the Garmin® folder on the memory card.
- 4 Remove the memory card from your device.
- 5 Open the Garmin Express app on your computer.
- 6 Insert the memory card into your computer.
- 7 If necessary, select **Get Started**.
- 8 If necessary, while the application searches, select **Sign In** next to **Have marine charts or devices?** near the bottom of the screen.
- 9 Create or sign in to your Garmin account.
- 10 Follow the on-screen instructions to set up your vessel.
- 11 Select **+ > Add**.
The Garmin Express application searches the memory card for the device information.
- 12 Select **Add Device** to register the device.
When registration is complete, the Garmin Express application searches for additional charts and chart updates for your device.

When you add devices to the chartplotter network, repeat these steps to register the new devices using the Garmin Express app.

Updating Your Charts Using the Garmin Express™ App

The internal card readers support up to 32 GB memory cards, formatted to FAT32 with speed class 4 or higher. Use of an 8 GB or larger memory card with speed class 10 is recommended.

Downloading the chart update may take up to a few hours.

You should use a blank memory card for chart updates. The update process erases the content on the card and reformats the card.

- 1 Install the Garmin Express app on your computer (*Installing the Garmin Express™ App on a Computer, page 214*).
- 2 Open the Garmin Express app on your computer.
- 3 Select your vessel and device.
- 4 If chart updates are available, select **Chart Updates > Continue**.
- 5 Read and agree to the terms.
- 6 Insert your chartplotter chart memory card into the computer.
- 7 Select the drive for the memory card.
- 8 Review the reformat warning, and select **OK**.
- 9 Wait while the chart update is copied to the memory card.
Copying the update file onto the card may take from a few minutes up to a few hours.

As of software version 34.00, you can connect an external USB card reader and use a memory card up to 1 TB, formatted to exFAT with speed class 10 or higher.

- 10 Close the Garmin Express app.
- 11 Eject the memory card from the computer.
- 12 Turn on the chartplotter.
- 13 After the home screen appears, insert the memory card into the card slot.
NOTE: In order for the update instructions to appear, the device must be fully booted before the card is inserted.
- 14 Select **Update Software > Yes**.
- 15 Wait several minutes while the update process completes.
- 16 When prompted, leave the memory card in place, and restart the chartplotter.
- 17 Remove the memory card.
NOTE: If the memory card is removed before the device restarts fully, the update is not complete.

Software Updates

You may need to update the software when you install a new device or add an accessory.

You can use the ActiveCaptain® mobile app to update the device software (*Updating Software with the ActiveCaptain® App, page 35*).

You can also use the Garmin Express™ desktop app to update your chartplotter software (*Loading the New Software on a Memory Card Using Garmin Express™, page 215*).

The internal card readers support up to 32 GB memory cards, formatted to FAT32 with speed class 4 or higher. Use of an 8 GB or larger memory card with speed class 10 is recommended.

The Garmin® memory card reader accessory is sold separately.

Before you update the software, you should check the software version installed on your device (*Viewing System Software Information, page 201*). Then, you can go to garmin.com/support/software/marine.html, select See All Devices in this Bundle, and compare the installed software version to the software version listed for your product.

If the software version installed on your device is older than the version listed on the website, you should update the software using the ActiveCaptain mobile app (*Updating Software with the ActiveCaptain® App, page 35*) or the Garmin Express desktop app (*Loading the New Software on a Memory Card Using Garmin Express™, page 215*).

Loading the New Software on a Memory Card Using Garmin Express™

You can copy the software update to a memory card using a computer with the Garmin Express app.

The internal card readers support up to 32 GB memory cards, formatted to FAT32 with speed class 4 or higher. Use of an 8 GB or larger memory card with speed class 10 is recommended.

Downloading the software update may take from a few minutes up to a few hours.

You should use a blank memory card for software updates. The update process erases the content on the card and reformats the card.

- 1 Insert a memory card into the card slot on the computer.
- 2 Install the Garmin Express app (*Installing the Garmin Express™ App on a Computer, page 214*).
- 3 Select your vessel and device.
- 4 Select **Software Updates > Continue**.
- 5 Read and agree to the terms.
- 6 Select the drive for the memory card.
- 7 Review the reformat warning, and select **Continue**.
- 8 Wait while the software update is copied to the memory card.
 Copying the update file onto the card may take from a few minutes up to a few hours.
- 9 Close the Garmin Express app.
- 10 Eject the memory card from the computer.

After loading the update onto the memory card, install the software on the chartplotter (*Updating the Device Software Using a Memory Card, page 216*).

As of software version 34.00, you can connect an external USB card reader and use a memory card up to 1 TB, formatted to exFAT with speed class 10 or higher.

Updating the Device Software Using a Memory Card

To update the software using a memory card, you must obtain a software-update memory card or load the latest software onto a memory card using the Garmin Express™ app (*Loading the New Software on a Memory Card Using Garmin Express™*, page 215).

- 1 Turn on the chartplotter.
- 2 After the home screen appears, insert the memory card into the card slot.
NOTE: In order for the software update instructions to appear, the device must be fully booted before the card is inserted.
- 3 Select **Install Now > Update Software > Yes**.
- 4 Wait several minutes while the software update process completes.
- 5 When prompted, leave the memory card in place, and restart the chartplotter.
- 6 Remove the memory card.

NOTE: If the memory card is removed before the device restarts fully, the software update is not complete.

NMEA® 0183 with Audio Cable

The NMEA 0183 with audio cable (010-12852-00) features bare wires and an RCA connector for an audio out connection to a stereo, including Fusion® stereos. You can purchase this cable from garmin.com or your local Garmin® dealer.

After installing the cable, you can connect the RCA connectors to the AUX input of the stereo. Audio from the chartplotter, including audio from a source connected to the HDMI® port, is then output to the AUX source of the stereo.

The cable also provides one NMEA 0183 input and output port.

Touchscreen Controls for a Connected Computer (GPSMAP® 8x10/8x12/8x16)

NOTICE

To prevent corrosion due to moisture, you must use Garmin® GPSMAP accessory cables when connecting the chartplotter to the computer. Using different cables voids your warranty.

You can connect the chartplotter to a computer to see the computer screen on the chartplotter touchscreen and control the computer using the chartplotter touchscreen. To see the computer screen, you must connect the computer to the HDMI IN port. To control the computer, you must connect the computer to the USB DRD port.

The Garmin HDMI® accessory cable (010-12390-20) is 4.5 m (15 ft) long. If you need a longer cable, you should use an active HDMI cable only. You need an HDMI coupler to connect the two HDMI cables.

The recommended Garmin USB Cable (010-12390-14) is 4.5 m (15 ft) long. If you need a longer cable, you should use a USB hub or USB repeater extension cable only.

NOTICE

To avoid potential communication errors, you should use the correct USB cable for your chartplotter. You should not use an adapter to change the USB connector type on an older cable.

You must make all cable connections in a dry environment.

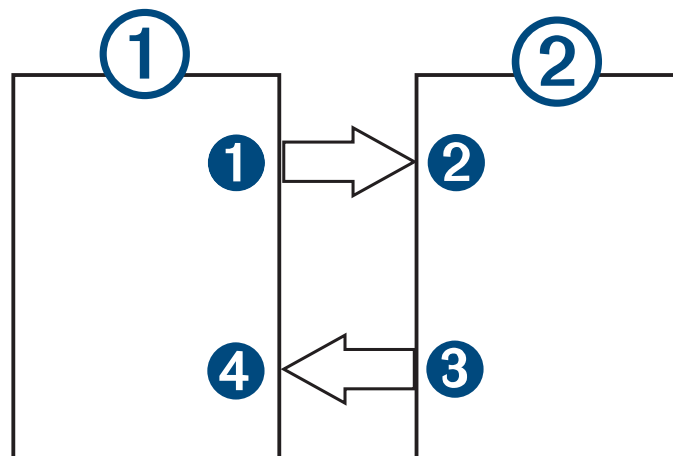

Devices

Item	Device
①	Computer
②	GPSMAP chartplotter

Connections

From	To	Cable
① Computer's HDMI OUT port	② Chartplotter's HDMI IN port	Garmin HDMI Cable (010-12390-20)
③ Chartplotter's USB DRD port	④ Computer's USB port	Garmin USB-C to USB-A Cable (010-12390-14)

Touchscreen Controls for a Connected Computer (GPSMAP® 9500 Black Box)

NOTICE

To prevent corrosion due to moisture, you must use Garmin® GPSMAP accessory cables when connecting the chartplotter to the computer. Using different cables voids your warranty.

You can connect the chartplotter to a computer to see the computer screen and to control the computer using a touchscreen. To see the computer screen, you must connect the computer to the HDMI IN port and connect the touchscreen to the HDMI OUT port. To control the computer using the chartplotter touchscreen, you must connect the computer to the USB DRD port and connect the touchscreen to the USB port.

The HDMI® Cable (010-12390-20) is 4.5 m (15 ft) long. If you need a longer cable, you should use an active HDMI cable only. You need an HDMI coupler to connect the two HDMI cables.

The recommended Garmin USB Cable (010-12390-14) is 4.5 m (15 ft) long. If you need a longer cable, you should use a USB hub, USB repeater, or USB extension cable only.

NOTICE

To avoid potential communication errors, you should use the correct USB cable for your chartplotter. You should not use an adapter to change the USB connector type on an older cable.

You must make all cable connections in a dry environment.

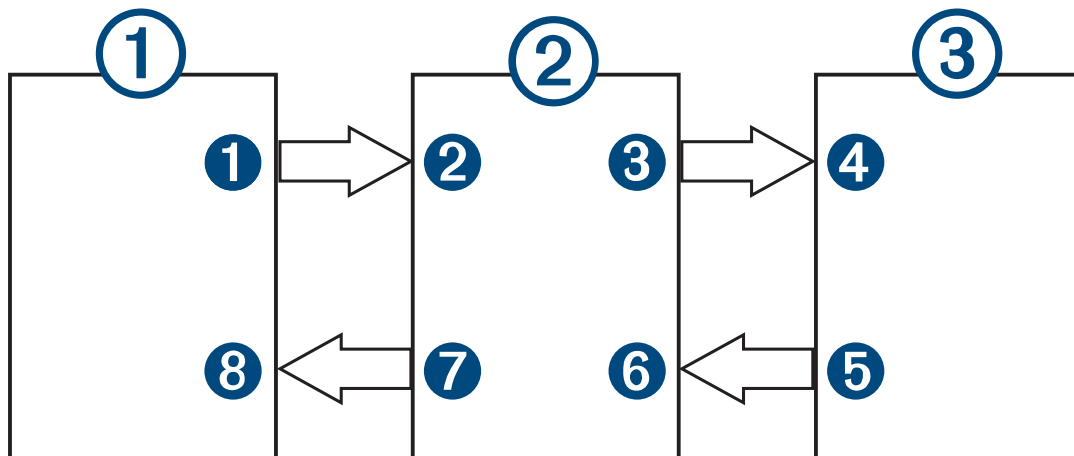

Devices

Item	Device
①	Computer
②	GPSMAP chartplotter
③	Touchscreen monitor

Connections

From	To	Cable
1 Computer's HDMI OUT port	2 Chartplotter's HDMI IN port	Garmin HDMI Cable (010-12390-20)
3 Chartplotter's HDMI OUT port	4 Monitor's HDMI IN port	Garmin HDMI Cable (010-12390-20)
5 Monitor's USB port	6 Chartplotter's USB port	Garmin USB-C to USB-A Cable (010-12390-12)
7 Chartplotter's USB DRD port	8 Computer's USB port	Garmin USB-C to USB-A Cable (010-12390-14)

Controlling a Computer with the Chartplotter

Before you can control a computer using the chartplotter, you must connect the chartplotter and computer correctly. See the chartplotter installation instructions for connection information.

- 1 Select **Vessel > Video**.
- 2 Select the HDMI® source for the computer.
- 3 Select **Options > USB Touch Out**.
You can now control your computer using two-finger touch gestures on the chartplotter screen.
- 4 If necessary, select **Options > Full Screen** to view the computer screen in full screen mode.
TIP: To exit full screen mode, press .

Viewing Images on a Memory card



You can view images that are saved on a memory card. You can view .jpg, .png, and .bmp files.

- 1 Insert a memory card with image files into the card slot.
- 2 Select  > **Image Viewer**.
- 3 Select the folder containing the images.
- 4 Wait a few seconds for the thumbnail images to load.
- 5 Select an image.
- 6 Use the arrows to scroll through the images.
- 7 If necessary, select **Options > Start Slideshow**.

Screenshots

You can capture a screenshot of any screen shown on your chartplotter as a .png file. You can transfer the screenshot to your computer. You can also view the screenshot in the image viewer ([Viewing Images on a Memory card, page 218](#)).

Capturing Screenshots

- 1 Insert a memory card into the card slot.
- 2 Go to a screen you want to capture.
- 3 Hold  or  for at least six seconds.

A message appears to confirm the screenshot was captured, including the name of the file written to the memory card.

Copying Screenshots to a Computer

- 1 Remove the memory card from the chartplotter, and insert it into a card reader that is attached to a computer.
- 2 From Windows® Explorer, open the Garmin\scrn folder on the memory card.
- 3 Copy the image file from the card and paste it to any location on the computer.

Troubleshooting

My device will not acquire GPS signals

If the device is not acquiring satellite signals, there could be a few causes. If the device has moved a large distance since the last time it has acquired satellites or has been turned off for longer than a few weeks or months, the device may not be able to acquire the satellites correctly.

- Ensure the device is using the latest software. If not, update the device software ([Software Updates, page 215](#)).
- If the device is using an internal GPS antenna, make sure the device has a clear view of the sky so the internal antenna can receive the GPS signal. If it is mounted inside of a cabin, it should be close to a window so it can receive the GPS signal. If the device is mounted inside a cabin and cannot be placed in a location where the device can acquire satellites, use an external GPS antenna.
- If the device is using an external GPS antenna, make sure the antenna is connected to the chartplotter or the NMEA® network. If necessary, see the GPS antenna installation instructions for connection information and diagrams.
- If the device is using an external GPS antenna connected using the NMEA 2000® network, select  > **Communications > NMEA 2000 Setup > Device List**. Make sure the antenna appears on this list. If it does not, verify the antenna installation and the NMEA 2000 network installation.
- If the device has more than one GPS antenna source, select a different source ([Selecting the GPS Source, page 20](#)).

My device will not turn on or keeps turning off

Devices erratically turning off or not turning on could indicate an issue with the power supplied to the device. Check these items to attempt to troubleshoot the cause of the power issue.

- Make sure the power source is generating power.
You can check this several ways. For example, you can check whether other devices powered by the source are functioning.
- Check the fuse in the power cable.
The fuse should be located in a holder that is part of the red wire of the power cable. Check that the proper size fuse is installed. Refer to the label on the cable or the installation instructions for the exact fuse size needed. Check the fuse to make sure there is still a connection inside of the fuse. You can test the fuse using a multimeter. If the fuse is good, the multimeter reads 0 ohm.
- Check to make sure the device is receiving at least 12 Vdc.
To check the voltage, measure the female power and ground sockets of the power cable for DC voltage. If the voltage is less than 12 Vdc, the device will not turn on.
- If the device is receiving enough power but does not turn on, contact Garmin® product support.

My device is not creating waypoints in the correct location

You can manually enter a waypoint location to transfer and share data from one device to the next. If you have manually entered a waypoint using coordinates, and the location of the point does not appear where the point should be, the map datum and position format of the device may not match the map datum and position format originally used to mark the waypoint.

Position format is the way in which the GPS receiver's position appears on the screen. This is commonly displayed as latitude/longitude in degrees and minutes, with options for degrees, minutes and second, degrees only, or one of several grid formats.

Map datum is a math model which depicts a part of the surface of the earth. Latitude and longitude lines on a paper map are referenced to a specific map datum.

- 1 Find out which map datum and position format was used when the original waypoint was created.
If the original waypoint was taken from a map, there should be a legend on the map that lists the map datum and position format used to create that map. Most often this is found near the map key.
- 2 Select  > **Preferences > Units**.
- 3 Select the correct map datum and position format settings.
- 4 Create the waypoint again.

Specifications

GPSMAP® 8x10 Specifications

Dimensions (W × H × D)	259.9 × 205.1 × 75.1 mm (10 ¹ / ₄ × 8 ¹ / ₁₆ × 2 ¹⁵ / ₁₆ in.)
Dimensions on bail mount (W × H × D)	259.9 × 221.6 × 103.5 mm (11 ¹ / ₁₆ × 8 ³ / ₄ × 4 ¹ / ₁₆ in.)
Display size (W × H)	218.4 × 136.9 mm (8 ⁵ / ₈ × 5 ³ / ₈ in.) 10 in. diagonal
Display resolution	WUXGA, 1920 × 1200 pixels
Weight	2.4 kg (5.2 lb.)
Compass-safe distance	45 cm (17.7 in.)
Clearance behind flush-mounted device	11.1 cm (4 ³ / ₈ in.)
Temperature range	From -15° to 55°C (from 5° to 131°F)
Material	Polycarbonate plastic and die-cast aluminum
Water rating	IEC 60529 IPX7 ⁶
Fuse	10 A, 125 V fast-acting
Input voltage	From 10 to 32 Vdc
Max. power usage at 10 Vdc	40.1 W
Typical current draw at 12 Vdc	1.5 A
Max. current draw at 12 Vdc	6.0 A
NMEA 2000® LEN @ 9 Vdc	2
NMEA 2000 draw	75 mA max.
Max. waypoints	5,000
Max. routes	100 (250 waypoints each)
Max. active track points	50,000 points, 50 saved tracks
Memory card	2 microSD® memory card slots, 32 GB max card size.
Wireless frequency and protocols	Wi-Fi® and ANT® technologies 2.4 GHz @ 12.3 dBm nominal
HTML integration	Compatible with OneHelm™ integration

GPSMAP® 8x12 Specifications

Dimensions (W × H × D)	302.8 × 216.4 × 76.5 mm (11 ¹⁵ / ₁₆ × 8 ¹ / ₂ × 4 ⁵ / ₈ in.)
Dimensions on bail mount (W × H × D)	323.9 × 216.4 × 104.5 mm (12 ³ / ₄ × 9 ³ / ₁₆ × 4 ¹ / ₈ in.)
Display size (W × H)	257.3 × 145.2 mm (10 ¹ / ₈ × 5 ¹¹ / ₁₆ in.) 11.6 in. diagonal
Display resolution	FHD, 1920 × 1080 pixels
Weight	2.7 kg (6.0 lb.)
Compass-safe distance	35 cm (13.8 in.)
Clearance behind flush-mounted device	11.1 cm (4 ³ / ₈ in.)
Temperature range	From -15° to 55°C (from 5° to 131°F)
Material	Polycarbonate plastic and die-cast aluminum
Water rating	IEC 60529 IPX7 ⁶
Fuse	10 A, 125 V fast-acting
Input voltage	From 10 to 32 Vdc
Max. power usage at 10 Vdc	45 W

⁶ The device withstands incidental exposure to water of up to 1 m for up to 30 min. For more information, go to www.garmin.com/waterrating.

Typical current draw at 12 Vdc	1.3 A
Max. current draw at 12 Vdc	6.0 A
NMEA 2000® LEN @ 9 Vdc	2
NMEA 2000 draw	75 mA max.
Max. waypoints	5,000
Max. routes	100 (250 waypoints each)
Max. active track points	50,000 points, 50 saved tracks
Memory card	2 microSD® memory card slots, 32 GB max card size.
Wireless frequency and protocols	Wi-Fi® and ANT® technologies 2.4 GHz @ 12.3 dBm nominal
HTML integration	Compatible with OneHelm™ integration

GPSPMAP® 8x16 Specifications

Dimensions (W × H × D)	384.7 × 262.6 × 76 mm (15 ¹ / ₈ × 10 ⁵ / ₁₆ × 3 in.)
Dimensions on bail mount (W × H × D)	405.6 × 279.1 × 103 mm (15 ¹⁵ / ₁₆ × 11 × 4 ¹ / ₁₆ in.)
Display size (W × H)	345.2 × 194.6 mm (13 ⁹ / ₁₆ × 7 ¹¹ / ₁₆ in.) 15.6 in. diagonal
Display resolution	FHD, 1920 × 1080 pixels
Weight	4.4 kg (9.6 lb.)
Clearance behind flush-mounted device	11.1 cm (4 ³ / ₈ in.)
Compass-safe distance	105 cm (41.3 in.)
Temperature range	From -15° to 55°C (from 5° to 131°F)
Material	Polycarbonate plastic and die-cast aluminum
Water rating	IEC 60529 IPX7 ⁶
Fuse	10 A, 125 V fast-acting
Input voltage	From 10 to 32 Vdc
Max. power usage at 10 Vdc	52.1 W
Typical current draw at 12 Vdc	1.3 A
Max. current draw at 12 Vdc	6.0 A
NMEA 2000® LEN @ 9 Vdc	2
NMEA 2000 draw	75 mA max.
Max. waypoints	5,000
Max. routes	100 (250 waypoints each)
Max. active track points	50,000 points, 50 saved tracks
Memory card	2 microSD® memory card slots, 32 GB max card size.
Wireless frequency and protocols	Wi-Fi® and ANT® technologies 2.4 GHz @ 12.3 dBm nominal
HTML integration	Compatible with OneHelm™ integration

GPSPMAP® 8x17 Specifications

Specification	Measurement
Dimensions (W × H × D)	41.9 × 30.7 × 7.1 cm (16.5 × 12.1 × 2.8 in.)
Display size (W × H)	36.6 × 23.1 cm (14.4 × 9.1 in.)
Display resolution	WUXGA, 1920 × 1200 pixels
Weight	5.2 kg (11.48 lb.)

⁶ The device withstands incidental exposure to water of up to 1 m for up to 30 min. For more information, go to www.garmin.com/waterrating.

Specification	Measurement
Compass-safe distance	Device: 53.34 cm (21 in.) Device and sun cover: 99.06 cm (39 in.) Sun cover: 48.26 cm (19 in.)
Temperature range	From -15° to 55°C (from 5° to 131°F)
Material	Polycarbonate plastic and die-cast aluminum
Water rating	IEC 60529 IPX7 ⁶
Fuse	15 A
Input voltage	From 10 to 35 Vdc
Max. power usage	40 W
Typical current draw at 12 Vdc	2.8 A
Typical current draw at 24 Vdc	1.4 A
Max. current draw	3.5 A
NMEA 2000® LEN @ 9 Vdc	2
NMEA 2000 Draw	75 mA max.
Max. waypoints	5,000
Max. routes	100
Max. active track points	50,000 points, 50 saved tracks
Wireless frequency and protocols	Wi-Fi®, ANT®, and Bluetooth® technologies 2.4 GHz @ 17.21 dBm max.
HTML integration	Compatible with OneHelm™ integration

GPSPMAP® 8x22 Specifications

Specification	Measurement
Dimensions (W × H × D)	52.8 × 35.1 × 7.1 cm (20.8 × 13.8 × 2.8 in.)
Display size (W × H)	47.8 × 27.0 cm (18.8 × 10.6 in.)
Display resolution	FHD, 1920 × 1080 pixels
Weight	7.1 kg (15.63 lb.)
Compass-safe distance	Device: 68.58 cm (27 in.) Device and sun cover: 111.76 cm (44 in.) Sun cover: 43.18 cm (17 in.)
Temperature range	From -15° to 55°C (from 5° to 131°F)
Material	Polycarbonate plastic and die-cast aluminum
Water rating	IEC 60529 IPX7 ⁶
Fuse	15 A
Input voltage	From 10 to 35 Vdc
Max. power usage	59 W
Typical current draw at 12 Vdc	3.9 A
Typical current draw at 24 Vdc	1.8 A
Max. current draw	4.9 A
NMEA 2000® LEN @ 9 Vdc	2
NMEA 2000 Draw	75 mA max.
Max. waypoints	5,000
Max. routes	100
Max. active track points	50,000 points, 50 saved tracks

⁶ The device withstands incidental exposure to water of up to 1 m for up to 30 min. For more information, go to www.garmin.com/waterrating.

Specification	Measurement
Wireless frequency and protocols	Wi-Fi®, ANT®, and Bluetooth® technologies 2.4 GHz @ 17.21 dBm max.
HTML integration	Compatible with OneHelm™ integration

GPSMAP® 8x24 Specifications

Specification	Measurement
Dimensions (W × H × D)	60.0 × 41.0 × 7.1 cm (22.8 × 16.1 × 2.8 in.)
Display size (W × H)	51.8 × 32.5 cm (20.4 × 12.8 in.)
Display resolution	WUXGA, 1920 × 1200 pixels
Weight	8.6 kg (18.95 lb.)
Compass-safe distance	Device: 73.66 cm (29 in.) Device and sun cover: 124.46 cm (49 in.) Sun cover: 43.18 cm (17 in.)
Temperature range	From -10° to 55°C (from 14° to 131°F)
Material	Polycarbonate plastic and die-cast aluminum
Water rating	IEC 60529 IPX7 ⁶
Fuse	15 A
Input voltage	From 10 to 35 Vdc
Max. power usage	87 W
Typical current draw at 12 Vdc	6.1 A
Typical current draw at 24 Vdc	2.8 A
Max. current draw	7.6 A
NMEA 2000® LEN @ 9 Vdc	2
NMEA 2000 Draw	75 mA max.
Max. waypoints	5,000
Max. routes	100
Max. active track points	50,000 points, 50 saved tracks
Wireless frequency and protocols	Wi-Fi®, ANT®, and Bluetooth® technologies 2.4 GHz @ 17.21 dBm max.
HTML integration	Compatible with OneHelm™ integration

GPSMAP® 8700 Specifications

Dimensions (W × H × D)	38.3 × 19.8 × 4.7 cm (15 ¹ / ₈ × 7 ¹³ / ₁₆ × 1 ⁷ / ₈ in.)
Clearance on front of device	8.6 cm (3 ³ / ₈ in.)
Weight	1.39 kg (3.06 lb.)
Compass-safe distance	2.54 cm (1 in.)
Temperature range	From -15° to 55°C (from 5° to 131°F)
Material	Polycarbonate plastic and die-cast aluminum
Water rating	IEC 60529 IPX7 ⁶
Fuse	10 A, 42 V fast-acting
Input voltage	From 10 to 32 Vdc
Max. power usage at 10 Vdc	40.1 W
Typical current draw at 12 Vdc	1.5 A
Max. current draw at 12 Vdc	6.0 A

⁶ The device withstands incidental exposure to water of up to 1 m for up to 30 min. For more information, go to www.garmin.com/waterrating.

NMEA 2000® LEN @ 9 Vdc	2
NMEA 2000 draw	75 mA max.
Max. waypoints	5,000
Max. routes	100 (250 waypoints each)
Max. active track points	50,000 points, 50 saved tracks
HTML integration	Compatible with OneHelm™ integration
Memory card	External card reader required (not included)
Wireless frequency and protocols	Wi-Fi® and ANT® technologies 2.4 GHz @ 14.15 dBm maximum

Sonar Models Specifications

Specification	Measurement
Sonar frequencies ⁶	Traditional: 50/200, 77/200, 83/200 kHz Single Channel CHIRP: from 40 to 250 kHz Garmin ClearVü™ CHIRP: 260/455/800 kHz Ultra High-Definition Garmin ClearVü: 800 kHz, CHIRP range: 760 to 880 kHz Ultra High-Definition SideVü: 1,200 kHz, CHIRP range: 1,060 to 1,170 kHz
Sonar transmit power (RMS) ⁷	CHIRP: 1000 W Garmin ClearVü and SideVü CHIRP: 500 W
Sonar depth ⁸	5,000 ft. at 1 kW

Recommended Startup Image Dimensions

For the best fit for the startup images, use an image that has the following dimensions, in pixels.

Model	Display resolution	Image width	Image height
GPSMAP® 8x12, 8x16, and 8x22	FHD	1240	450
GPSMAP 8x10, 8x17, and 8x24	WUXGA	1700	650

NMEA 2000® PGN Information

Transmit and Receive

PGN	Description
059392	ISO acknowledgment
059904	ISO request
060160	ISO transport protocol: Data transfer
060416	ISO transport protocol: Connection management
060928	ISO address claimed
126208	Request group function
126993	Heartbeat
126996	Product information
126998	Configuration information
127237	Heading/track control
127245	Rudder
127250	Vessel heading
127258	Magnetic variance
127488	Engine parameters: Rapid update
127489	Engine parameters: Dynamic

⁶ Dependent upon the transducer.

⁷ Dependent upon the transducer rating and depth.

⁸ Dependent upon the transducer, water salinity, bottom type, and other water conditions.

PGN	Description
127490	Electric drive status: Dynamic
127491	Electric energy storage status: Dynamic
127493	Transmission parameters: Dynamic
127494	Electric drive information
127495	Electric energy storage information
127505	Fluid level
127508	Battery status
128002	Electric drive status: Rapid update
128003	Electric energy storage status: Rapid update
128259	Speed: Water referenced
128267	Water depth
129025	Position: Rapid update
129026	COG and SOG: Rapid update
129029	GNSS position data
129283	Cross track error
129284	Navigation data
129285	Navigation - route/waypoint information
129539	GNSS DOPs
129540	GNSS satellites in view
130060	Label
130306	Wind data
130310	Environmental parameters (obsolete)
130312	Temperature (obsolete)

Transmit

PGN	Description
126464	Transmit and receive PGN list group function
126984	Alert response
127258	Magnetic variation
127497	Trip parameters: Engine
127502	Switch bank control (DEPRECATED)

Receive

PGN	Description
065240	Commanded address
126983	Alert
126985	Alert text
126987	Alert threshold
126988	Alert value
126992	System time
127233	Man overboard
127237	Heading/track control
127245	Rudder
127251	Rate of turn
127252	Heave
127257	Attitude

PGN	Description
127498	Engine parameters: Static
127501	Switch bank status
127503	AC input status (obsolete)
127504	AC output status (obsolete)
127506	DC detailed status
127507	Charger status
127509	Inverter status
128000	Nautical leeway angle
128275	Distance log
128780	Linear actuator
129038	AIS class A position report
129039	AIS class B position report
129040	AIS class B extended position report
129041	AIS Aids to Navigation (AtoN) report
129044	Datum
129285	Navigation: Route, waypoint information
129794	AIS class A static and voyage related data
129798	AIS SAR aircraft position report
129799	Radio frequency/mode/power
129802	AIS safety-related broadcast message
129808	DSC call Information
129809	AIS class B "CS" static data report, part A
129810	AIS class B "CS" static data report, part B
130067	Route and waypoint service: Route, waypoint name and position
130311	Environmental parameters (obsolete)
130313	Humidity
130314	Actual pressure
130316	Temperature: Extended range
130569	Entertainment: Current file and status
130570	Entertainment: Library data file
130571	Entertainment: Library data group
130573	Entertainment: Supported source data
130574	Entertainment: Supported zone data
130576	Trim tab status
130577	Direction data

J1939 Information

The chartplotter can receive J1939 sentences. The chartplotter cannot transmit over the J1939 network.

Description	PGN	SPN
Engine percent load at current speed	61443	92
Engine speed	61444	190
Engine manifold exhaust gas temperature - right manifold	65031	2433
Engine manifold exhaust gas temperature - left manifold	65031	2434
Engine auxiliary coolant	65172	
Active diagnostic trouble codes	65226	

Description	PGN	SPN
Vehicle distance	65248	
Water in fuel indicator	65279	
Engine wait to start lamp	65252	1081
Engine over speed test	65252	2812
Engine air shutoff command status	65252	2813
Engine alarm output command status	65252	2814
Engine total hours of operation	65253	247
Navigation-based vehicle speed	65256	517
Engine fuel temperature 1	65262	174
Engine oil temperature 1	65262	175
Engine fuel delivery pressure	65263	94
Engine oil pressure	65263	100
Engine coolant pressure	65263	109
Engine coolant temperature	65263	110
Engine coolant level	65263	111
Engine fuel rate	65266	183
Engine average fuel economy	65266	185
Engine intake manifold #1 pressure	65270	102
Battery potential / power input 1	65271	168
Transmission oil temperature	65272	177
Transmission oil pressure	65272	127
Fuel level	65276	96
Engine oil filter differential pressure	65276	969

NMEA® 0183 Information

Transmit

Sentence	Description
GPAPB	APB: Heading or track controller (autopilot) sentence "B"
GPBOD	BOD: Bearing (origin to destination)
GPBWC	BWC: Bearing and distance to waypoint
GPGGA	GGA: Global positioning system fix data
GPGLL	GLL: Geographic position (latitude and longitude)
GPGSA	GSA: GNSS DOP and active satellites
GPGSV	GSV: GNSS satellites in view
GPRMB	RMB: Recommended minimum navigation information
GPRMC	RMC: Recommended minimum specific GNSS data
GP RTE	RTE: Routes
GPVTG	VTG: Course over ground and ground speed
GPWPL	WPL: Waypoint location
GPXTE	XTE: Cross track error
PGRME	E: Estimated error
PGRMM	M: Map datum
PGRMZ	Z: Altitude
SDDBT	DBT: Depth below transducer
SDDPT	DPT: Depth

Sentence	Description
SDMTW	MTW: Water temperature
SDVHW	VHW: Water speed and heading
TLB	Target label
TLL	Target latitude and longitude
TTD	Tracked target data
ZDA	Time and date

Receive

Sentence	Description
DPT	Depth
DBT	Depth below transducer
MTW	Water temperature
VHW	Water speed and heading
WPL	Waypoint location
DSC	Digital selective calling information
DSE	Expanded digital selective calling
HDG	Heading, deviation, and variation
HDM	Heading, magnetic
MWD	Wind direction and speed
MDA	Meteorological composite
MWV	Wind speed and angle
RTE	Routes
VDM	AIS VHF data-link message

You can purchase complete information about National Marine Electronics Association (NMEA) format and sentences from www.nmea.org.

Network Interfaces and Services

Devices connected to the chartplotter using a Garmin BlueNet™ cable, a Garmin® Marine Network cable, or other Ethernet cable use these network interfaces and services. These interfaces and services are enabled by default, cannot be disabled, and are required for proper equipment operation.

- Garmin proprietary services
- DHCP
- HTTP
- LLDP
- NFS
- RPC Bind
- SSH
- Telnet
- mDNS

NOTE: When you connect a new chartplotter to the network, private information is synchronized with the newly-added device.

© 2019 Garmin Ltd. or its subsidiaries

Garmin®, the Garmin logo, ActiveCaptain®, ANT®, Fusion®, GPSMAP®, and inReach® are trademarks of Garmin Ltd. or its subsidiaries, registered in the USA and other countries. ActiveCaptain®, Connect IQ™, ECHOMAP™, GMR Fantom™, Garmin BlueNet™, Garmin ClearVü™, Garmin Connect™, Garmin Express™, Garmin Nautix™, Garmin Navionics Vision+™, Garmin Quickdraw™, GC™, GCV™, GMR™, GRID™, GXM™, LiveScope™, MotionScope™, OneChart™, OneHelm™, OneVü™, Panoptix™, Reactor™, Spy™, SpyLink™, SpyLock™, SpyScan™, Shadow Drive™, SmartMode™, and SteadyCast™ are trademarks of Garmin Ltd. or its subsidiaries. These trademarks may not be used without the express permission of Garmin.

Mac® is a trademark of Apple Inc., registered in the U.S. and other countries. The Bluetooth® word mark and logos are owned by the Bluetooth SIG, Inc. and any use of such marks by Garmin is under license. Blu-Ray™ is a registered trademark of the Blu-ray Disc Association. Chromecast™ is a registered trademark of Google Inc. CZone™ is a trademark of Power Products, LLC. Color Thermal Vision™ is a trademark of FLIR Systems, Inc. FLIR® and MSX® are registered trademarks of FLIR Systems, Inc. HDMI® is a registered trademark of HDMI Licensing, LLC. Mercury® and Skyhook® are trademarks of Brunswick Corporation. NMEA®, NMEA 2000®, and the NMEA 2000 logo are registered trademarks of the National Marine Electronics Association. microSD® and the microSD logo are trademarks of SD-3C, LLC. Optimus®, and SeaStation® are registered trademarks of Dometic®. CHARGE™, C-Monster® and Power-Pole® are registered trademarks of JL Marine Systems, Inc. SD® and the SDHC logo are trademarks of SD-3C, LLC. SiriusXM® and all related marks and logos are trademarks of Sirius XM Radio Inc. All rights reserved. USB-C® is a registered trademark of USB Implementers Forum. Wi-Fi® is a registered mark of Wi-Fi Alliance Corporation. Windows® is a registered trademark of Microsoft Corporation in the United States and other countries. Yamaha®, the Yamaha logo, Command Link Plus®, and Helm Master® are trademarks of the YAMAHA Motor Co., LTD. All other trademarks and copyrights are the property of their respective owners.